



## 120 Series Explosion-Proof Pressure and Differential Pressure Switches

### Types

J120, J120K, H121, H121K, H122,  
H122K, H122P



UNITED ELECTRIC  
CONTROLS

## Installation and Maintenance Instructions

Please read all instructional literature carefully and thoroughly before starting. Refer to the final page for the listing of Recommended Practices, Liabilities and Warranties.

### GENERAL



MISUSE OF THIS PRODUCT MAY CAUSE EXPLOSION AND PERSONAL INJURY. THESE INSTRUCTIONS MUST BE THOROUGHLY READ AND UNDERSTOOD BEFORE UNIT IS INSTALLED.



THIS EQUIPMENT IS SUITABLE FOR USE IN CLASS I, DIVISIONS 1 & 2, GROUPS B, C AND D; CLASS II, DIVISIONS 1 & 2, GROUPS E, F AND G; CLASS III; OR NON-HAZARDOUS LOCATIONS ONLY.



THIS EQUIPMENT IS ATEX CERTIFIED FOR EQUIPMENT CATEGORY 2. SUITABLE FOR APPROPRIATE USE IN GAS ZONE 1 & DUST ZONE 21 APPLICATIONS.



0539 DEMKO 03 ATEX 0305048



II 2 G EEx d IIC T6



II 2 D T+ 85°C

-40°C ≤ TAMB. ≤ + 71°C, IP66



BEFORE INSTALLING, CHECK THE SENSOR MODEL SELECTED FOR COMPATIBILITY TO THE PROCESS MEDIA IN CONTACT WITH THE SENSOR AND WETTED PARTS.



PROOF PRESSURE\* LIMITS STATED IN THE LITERATURE AND ON NAMEPLATES MUST NEVER BE EXCEEDED, EVEN BY SURGES IN THE SYSTEM. OCCASIONAL OPERATION OF UNIT UP TO MAXIMUM PRESSURE IS ACCEPTABLE (E.G., START-UP, TESTING). CONTINUOUS OPERATION SHOULD NOT EXCEED THE DESIGNATED OVER RANGE PRESSURE.

**\*Proof Pressure:** The maximum pressure to which a pressure sensor may be occasionally subjected, which causes no permanent damage (e.g., start-up testing). The unit may require re-gapping.



THESE PRODUCTS DO NOT HAVE ANY FIELD REPLACEABLE PARTS. ANY SUBSTITUTION OF COMPONENTS MAY IMPAIR SUITABILITY FOR CLASS I, DIVISION 1.



TO PREVENT IGNITION OF HAZARDOUS ATMOSPHERES, DISCONNECT SUPPLY CIRCUITS BEFORE OPENING. KEEP COVER TIGHT WHILE CIRCUITS ALIVE.

The 120 Series pressure and differential pressure switches are actuated when a bellows, diaphragm or piston sensor responds to a pressure change. This response at a pre-determined set point(s) actuates a SPDT, DPDT or dual SPDT snap-acting microswitch(es),

which convert the pressure signal into an electrical signal. Control set point(s) may be varied by turning the internal adjustment hex (J120 models) or the external knob and pointer(s) (H121, H122, H122P models) according to the procedures outlined.

### Part I - Installation

#### Tools Needed

Screwdriver  
Adjustable Wrench to 1-1/2"

#### MOUNTING



THE CONNECTION OF THE DEVICE SHALL BE MADE BY CABLE ENTRIES OR A STOPPING BOX OF A FLAMEPROOF TYPE, CERTIFIED EEx d IIC. THESE ACCESSORIES SHALL BE THREADED INTO THE RELEVANT OPENING(S) OF THE DEVICE, WITH AT LEAST 5 THREADS ENGAGED AND WITH AT LEAST 8 mm LENGTH OF THREAD ENGAGEMENT. THESE ACCESSORIES ARE NOT INCLUDED WITHIN THIS ASSOCIATED HAZARDOUS LOCATIONS/ZONE 1 ATMOSPHERES APPROVAL.



TO PREVENT IGNITION, SEAL ALL CONDUIT RUNS WITHIN 18 INCHES OF ENCLOSURE.



ALWAYS HOLD A WRENCH ON THE PRESSURE HOUSING HEX WHEN MOUNTING UNIT. DO NOT TIGHTEN BY TURNING ENCLOSURE. THIS WILL DAMAGE SENSOR AND WEAKEN SOLDER OR WELDED JOINTS.

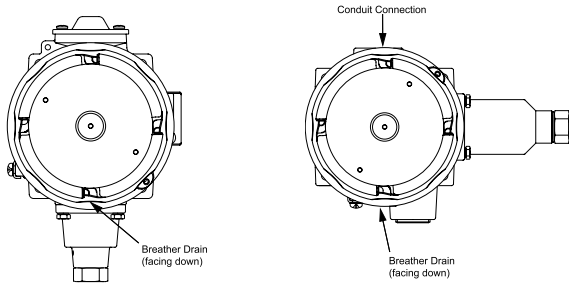


INSTALL UNITS WHERE SHOCK, VIBRATION AND TEMPERATURE FLUCTUATIONS ARE MINIMAL. MOUNT UNIT TO PREVENT MOISTURE FROM ENTERING THE ENCLOSURE. IT IS IMPERATIVE TO USE PROPERLY RATED EXPLOSION-PROOF SEALING FITTINGS FOR ELECTRICAL WIRE ENTRY. DO NOT MOUNT UNIT IN AMBIENT TEMPERATURES LOWER THAN -40°F (-40°C) OR HIGHER THAN 160°F (71°C).



J120 ENCLOSURES ARE PROVIDED WITH TWO 3/4" NPT ELECTRICAL CONDUIT OPENINGS, EITHER OF WHICH OR BOTH CAN BE USED DURING INSTALLATION. A 3/4" EXPLOSION PROOF PLUG IS PROVIDED FOR PROPERLY SEALING THE UNUSED CONDUIT OPENING. THE EXPLOSION PROOF PLUG MUST BE PROPERLY SEALED DURING PRODUCT INSTALLATION.

## Types J120, J120K, H121, H121K, H122, H122K, H122P



**Figure 1a:**  
H121, H121K, H122, H122K, H122P

**Figure 1b**  
J120, J120K

Mount controls vertically (pressure connection facing down, see Figure 1a) or horizontally (see Figure 1b). Control may be surface mounted via the four 1/4" screw holes on the enclosure or mounting bracket. It can also be mounted directly to a rigid pipe using the pressure connection.

### Controls with Breather Drain (Option M450)

#### Type J120, J120K Models 455-559

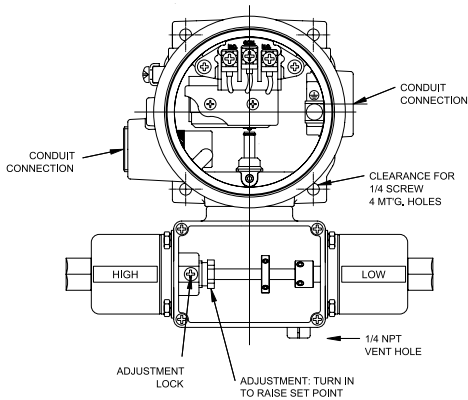
Mount with breather drain facing down (See Figure 1b). The conduit connection must be "potted" for this type of installation.

#### Types H121, H122 & H122P, All Models

Mount in vertical position with pressure assembly and breather drain facing down (See Figure 1a).

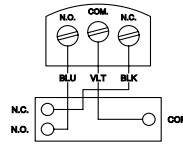
#### Differential Pressure Types J120K, H121K, H122K Opposed Sensor Models 36-39, (S)147(B)-(S)157(B), 367

"Opposed sensor" differential pressure switches should be mounted with their pressure connection in the horizontal position (See Figure 2). This will properly orient the 1/4" NPT venting conduit at the bottom of the third compartment (standardly supplied with plastic plug).

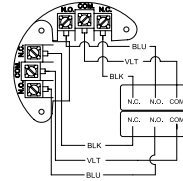


**Figure 2**  
Opposed Sensor Models

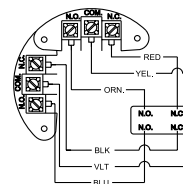
TYPES H121, J120, H121K, J120K



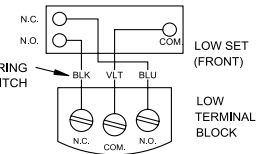
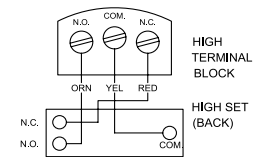
OPTION 1180,  
TYPE H122P



OPTION 1010, 1190, 1195  
TYPE J120



TYPES H122, H122K, H122P



NOTE REVERSE WIRING  
OF LOW SWITCH

HIGH SWITCH  
(BACK)  
LOW SWITCH  
(FRONT)

Use 75°C copper  
conductors only.  
Recommended  
tightening torque for  
field wiring terminals  
is 7-17 in.-lbs.

**Figure 3**

### WIRING



SUPPLY LEADWIRES MUST BE RATED 75°C MINIMUM COPPER CONDUCTOR ONLY.



DISCONNECT ALL SUPPLY CIRCUITS BEFORE WIRING UNIT. WIRE UNITS ACCORDING TO NATIONAL AND LOCAL ELECTRICAL CODES. MAXIMUM RECOMMENDED WIRE SIZE IS 14 AWG. THE RECOMMENDED TIGHTENING TORQUE FOR FIELD WIRING TERMINALS IS 7 TO 17 IN.-LBS.



ELECTRICAL RATINGS STATED IN LITERATURE AND ON NAMEPLATES MUST NOT BE EXCEEDED—OVERLOAD ON A SWITCH CAN CAUSE FAILURE ON THE FIRST CYCLE.



TO PREVENT SEIZURE OF ENCLOSURE COVER, DO NOT REMOVE LUBRICANT. THREADS SHOULD ALSO BE FREE OF DIRT, ETC.



THE EXTERNAL GROUNDING TERMINAL IS NOT TO BE USED AS THE PRIMARY EQUIPMENT GROUNDING TERMINAL. THE INTERNAL GROUNDING TERMINAL SHALL BE USED AS THE PRIMARY EQUIPMENT GROUNDING MEANS AND THE EXTERNAL GROUNDING TERMINAL IS ONLY FOR A SUPPLEMENTAL (SECONDARY) GROUNDING CONNECTION WHERE LOCAL AUTHORITIES PERMIT OR REQUIRE SUCH A CONNECTION.

Remove cover and wire control (See Figure 3). Replace cover and hand tighten to fully engage cover O-ring.

## Part II - Adjustments

### Tools Needed

Screwdriver  
5/8" Open End Wrench  
5/64" Allen Wrench



SOME MODELS HAVE A TWO-PIECE ADJUSTABLE PLUNGER. THIS FEATURE IS CHARACTERIZED BY A 3/16" HEX HEAD SCREW INSTALLED IN THE PLUNGER. THE LENGTH OF THIS ASSEMBLY IS ADJUSTED AT OUR FACTORY AND IS CRITICAL TO THE FUNCTION OF THE CONTROL. DURING NORMAL ADJUSTMENT, THESE COMPONENTS SHOULD NOT BE DISTURBED. REFER TO THE GAPPING PROCEDURE SECTION IF THE PLUNGERS ARE ACCIDENTALLY ADJUSTED



AFTER COMPLETING ADJUSTMENTS ON TYPE H121 AND H122 CONTROLS, BE SURE TO RE-INSTALL ADJUSTMENT COVER. DO NOT OVER TIGHTEN COVER SCREWS.

For set point adjustment and re-gapping, connect control to a calibrated pressure source.

### Types J120 (All) and J120K Models 455-559

Remove cover. Loosen phillips screw adjustment lock. Adjust set point by turning 5/8" hex adjustment screw clockwise (IN) to raise set point, or counterclockwise (OUT) to lower set point. Secure adjustment screw by tightening adjustment lock (see Figure 4a). Internal reference scales are provided to show which portion of the range (high or low) the control is set.

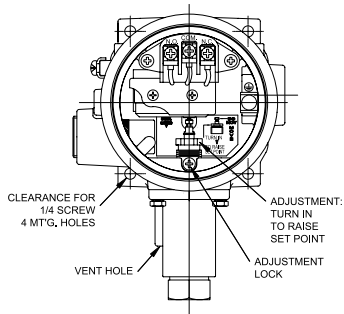


Figure 4a

### J120K: Opposed Sensor, Models 36-39, 147-157, S147B, S157B, 367

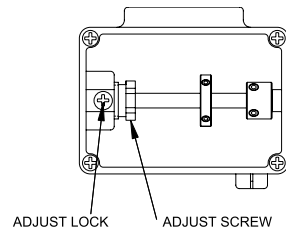


Figure 4b

### Type J120K Models 36-39, 147-S157B, & 367

Remove front cover and gasket from sensor assembly located below enclosure by unscrewing 4 phillips screws. Loosen phillips screw adjustment lock (see Figure 4b). Adjust set point by turning 5/8" hex screw clockwise (IN) to increase setting or counterclockwise (OUT) to decrease setting. Adjusting screw should be locked by tightening adjustment lock.

### Types H121, H121K

Adjust set point by turning external knob and pointer to desired setting on scale.

### Types H122, H122K

Individual microswitches may be set together or apart by up to 100% of range. When not set together, the front (Low) microswitch can not be set higher than the rear (High) microswitch. Turning external knobs will increase or decrease each switch setting independently.

### Types H122P

Individual switches may be set together or apart by up to 60% of range. The front switch is set by turning the internal calibrating screw to the right for lower set point and turning to the left for higher set point. When not set together, the front switch can not be set higher than the rear switch. Turning the external knob will increase or decrease each switch setting simultaneously without disturbing their relationship.

### Controls with Options

#### Option 1519, Adjustable Deadband Switch

This microswitch has an integral adjustment wheel. Turning this wheel raises and lowers the pressure rise set point. The fall set point remains constant. Consult factory for additional information.

#### Type J120, Option 1530, Manual Reset

This microswitch, when actuated, remains actuated until the pressure drops sufficiently to allow the reset knob (located on the left side of the control) to be manually turned to reset the microswitch.

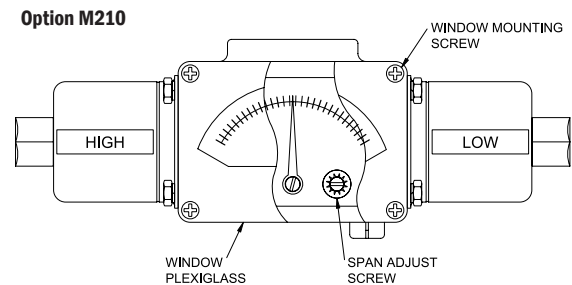


Figure 5

### Option M210 Indicator for Differential Pressure Controls, Span Adjustment

(See Figure 5). To adjust indication for maximum accuracy at any desired set point, follow steps 1 thru 3 listed below:

- 1) Remove front window and gasket (four screws) to gain access to span adjustment.
- 2) Connect control to calibrated gauges and set required differential pressure.
- 3) Using a screwdriver, slowly turn the span adjustment to obtain required indication. Remount the front gasket and window.

**NOTE:** Spanning adjustment will not affect the mid-range indication. The adjustment is factory calibrated and sealed to indicate tampering.



DO NOT FORCE SPAN ADJUSTMENT, SINCE PERMANENT DEFORMATION OF THE LINKAGE MECHANISM MAY RESULT.

## GAPPING PROCEDURE

### Tools Needed

5/8" Open End Wrench  
3/16" Open End Wrench (2)



GAPPING IS FACTORY-SET AND CRITICAL TO THE FUNCTION OF THE SWITCH. THIS PROCEDURE SHOULD ONLY BE PERFORMED IF THE PLUNGER HAS ACCIDENTALLY BEEN ADJUSTED.

- 1) Loosen adjustment lock.
- 2) Turn 5/8" hex adjustment screw IN, to approximately midrange. This puts a load on the sensor and exposes the plunger flats. (See Figure 6).
- 3) Using a 3/16" wrench on the plunger flats and a 3/16" wrench on the plunger hex screw, turn hex OUT from plunger until micro-switch actuates. If microswitch has already actuated, turn plunger hex screw IN until microswitch deactuates.
- 4) Continue per following instructions, depending on model.

### Models 171-174, 521-525, 531-535, and 540-548

Turn hex (IN) an additional 2 flats from this point (approximately 1/3 turn). This will provide a 9-11 mil gap.

### Models 680, 701-705, 356-376, 612, 616, 270, 274

Turn hex (IN) 3 flats from this point (approximately 1/2 turn). This will provide a 14-16 mil gap.

### Models 183-189, 190-194, 483-489, 490-494, 565-567

Turn hex (IN) 1 flat from this point. This will provide a 4-7 mil gap.



CONTACT FACTORY FOR ASSISTANCE WITH MODELS NOT SHOWN ABOVE.

### Re-Gapping Procedure for J120/J120K

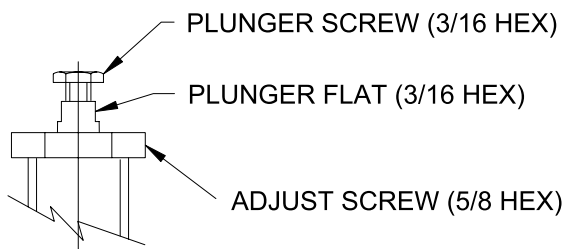
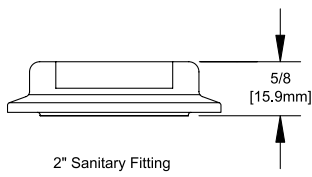


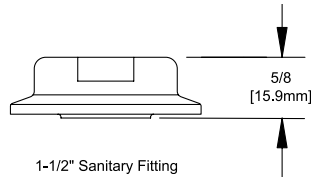
Figure 6





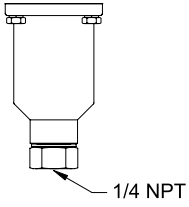
2" Sanitary Fitting

**Models 560-564**

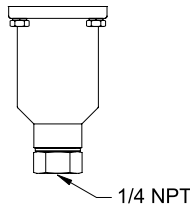


1-1/2" Sanitary Fitting

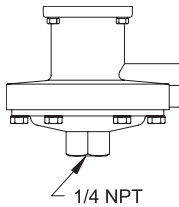
**Models 565-567**



1/4 NPT

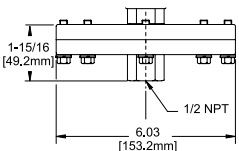


1/4 NPT

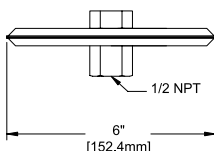


1/4 NPT

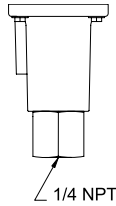
**J120 Models  
270-376, 680**



**H121/H122 Models  
270-376**



**Models 450-454,  
550-555**



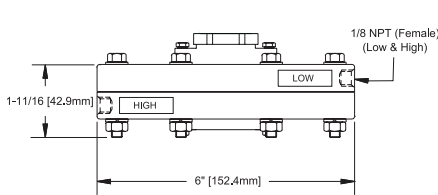
1/4 NPT

**Models 520-525**

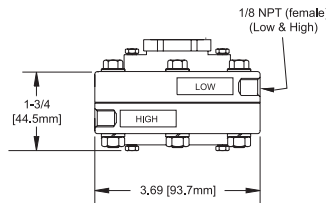
**Models 530-535**

**Models 612-616, 701-705,  
15622**

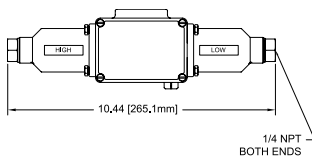
## Differential Pressure



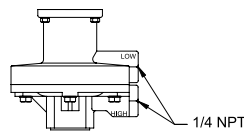
**Models 540-543**



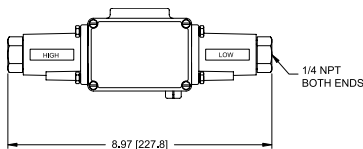
**Models 544-548**



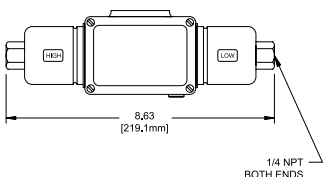
**J120K Models 367**



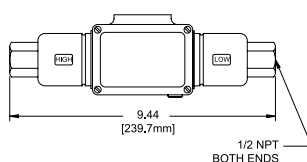
**Models 455-457, 559**



**J120K Models 36-39**



**Models 147 & 157**



**Models S147B & S157B**

## RECOMMENDED PRACTICES AND WARNINGS

United Electric Controls Company recommends careful consideration of the following factors when specifying and installing UE pressure and temperature units. Before installing a unit, the Installation and Maintenance instructions provided with unit must be read and understood.

- To avoid damaging unit, proof pressure and maximum temperature limits stated in literature and on nameplates must never be exceeded, even by surges in the system. Operation of the unit up to maximum pressure or temperature is acceptable on a limited basis (e.g., start-up, testing) but continuous operation must be restricted to the designated adjustable range. Excessive cycling at maximum pressure or temperature limits could reduce sensor life.
- A back-up unit is necessary for applications where damage to a primary unit could endanger life, limb or property. A high or low limit switch is necessary for applications where a dangerous runaway condition could result.
- The adjustable range must be selected so that incorrect, inadvertent or malicious setting at any range point cannot result in an unsafe system condition.
- Install unit where shock, vibration and ambient temperature fluctuations will not damage unit or affect operation. Orient unit so that moisture does not enter the enclosure via the electrical connection. When appropriate, this entry point should be sealed to prevent moisture entry.
- Unit must not be altered or modified after shipment. Consult UE if modification is necessary.
- Monitor operation to observe warning signs of possible damage to unit, such as drift in set point or faulty display. Check unit immediately.
- Preventative maintenance and periodic testing is necessary for critical applications where damage could endanger property or personnel.
- For all applications, a factory set unit should be tested before use.
- Electrical ratings stated in literature and on nameplate must not be exceeded. Overload on a switch can cause damage, even on the first cycle. Wire unit according to local and national electrical codes, using wire size recommended in installation sheet.
- Do not mount unit in ambient temp. exceeding published limits.

## LIMITED WARRANTY

Seller warrants that the product hereby purchased is, upon delivery, free from defects in material and workmanship and that any such product which is found to be defective in such workmanship or material will be repaired or replaced by Seller (Ex-works, Factory, Watertown, Massachusetts. INCOTERMS); provided, however, that this warranty applies only to equipment found to be so defective within a period of 24 months from the date of manufacture by the Seller (36 months for the Spectra 12 and One Series products; 18 months for Temperature Sensors). Seller shall not be obligated under this warranty for alleged defects which examination discloses are due to tampering, misuse, neglect, improper storage, and in any case where products are disassembled by anyone other than authorized Seller's representatives. EXCEPT FOR THE LIMITED WARRANTY OF REPAIR AND REPLACEMENT STATED ABOVE, SELLER DISCLAIMS ALL WARRANTIES WHATSOEVER WITH RESPECT TO THE PRODUCT, INCLUDING ALL IMPLIED WARRANTIES OF MERCHANTABILITY OR FITNESS FOR ANY PARTICULAR PURPOSE.

## LIMITATION OF SELLER'S LIABILITY

Seller's liability to Buyer for any loss or claim, including liability incurred in connection with (i) breach of any warranty whatsoever, expressed or implied, (ii) a breach of contract, (iii) a negligent act or acts (or negligent failure to act) committed by Seller, or (iv) an act for which strict liability will be inputted to seller, is limited to the "limited warranty" of repair and/or replacement as so stated in our warranty of product. In no event shall the Seller be liable for any special, indirect, consequential or other damages of a like general nature, including, without limitation, loss of profits or production, or loss or expenses of any nature incurred by the buyer or any third party.

UE specifications subject to change without notice.



UNITED ELECTRIC  
CONTROLS

180 Dexter Avenue, P.O. Box 9143  
Watertown, MA 02471-9143 USA  
Telephone: 617 926-1000 Fax: 617 926-2568  
<http://www.ueonline.com>