

# Gaugeable Tube Fittings and Adapter Fittings



- Available in tube sizes from 1/16 to 2 in. and 2 to 50 mm
- Consistent gaugeability upon initial installation
- Easy to disconnect and retighten
- Wide variety of materials and configurations

## Features

- Live-loaded, two-ferrule design.
- Easy to install.
- No torque is transmitted to tubing during installation.
- Swagelok® gap inspection gauge ensures sufficient pull-up upon initial installation.

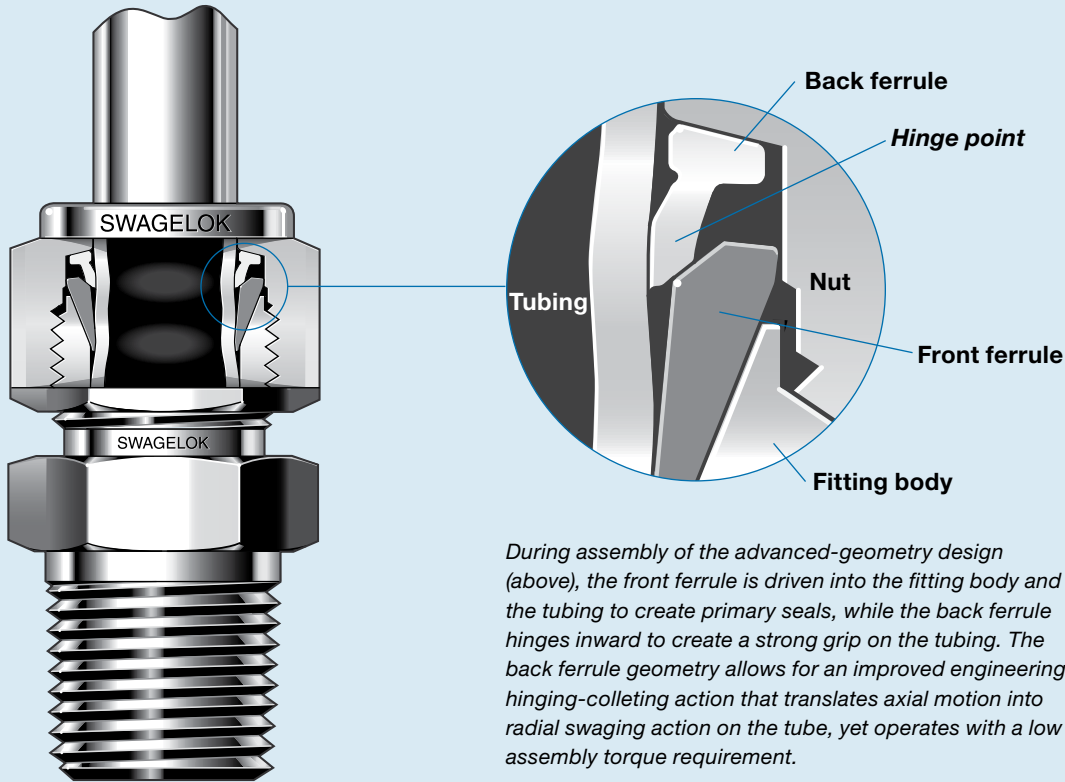

*During assembly of the advanced-geometry design (above), the front ferrule is driven into the fitting body and the tubing to create primary seals, while the back ferrule hinges inward to create a strong grip on the tubing. The back ferrule geometry allows for an improved engineering hinging-colleting action that translates axial motion into radial swaging action on the tube, yet operates with a low assembly torque requirement.*

### Two-Ferrule, Mechanical Grip Design

The two ferrules separate sealing and tube gripping functions; each ferrule is optimized for its function.

#### The front ferrule creates a seal:

- against the fitting body
- on the tubing outside diameter.

#### As the nut is turned, the back ferrule:

- axially advances the front ferrule
- radially applies an effective tube grip.

### Advanced-Geometry, Hinging-Colleting Back Ferrule Design

This design is standard on all 1/4 to 1/2 in. and 6 to 12 mm Swagelok stainless steel tube fittings to help installers make more consistent, leak-tight tube connections.

In these sizes, a patented case hardening process and patented recessed and contoured geometry provide unique engineering to the Swagelok back ferrule. The hinging-colleting back ferrule design expands on the already robust performance of the traditional ferrule design and provides:

- excellent gas-tight sealing and tube-gripping action
- easily achieved proper installation
- consistent remakes
- excellent vibration fatigue resistance and tube support
- full compatibility with original Swagelok stainless steel tube fittings of identical sizes.

For additional information, see the *316 Stainless Steel Swagelok Tube Fittings with Advanced Geometry Back Ferrules* technical report, MS-06-16.

## Contents

### Features, 2

### The Swagelok Tube Fitting Advantage, 6

### Materials, 8

### Alternative Fuels-Type Approval, 8

### Thread Specifications, 8

### O-Rings, 8

### Cleaning and Packaging, 8

### Metric Swagelok Tube Fittings, 9

### Pressure Ratings, 9

### Ordering Numbers and Dimensions, 10

#### Additional Products

- For SAF 2507 super duplex tube fittings, see the *Swagelok Gaugeable SAF 2507™ Super Duplex Tube Fittings* catalog, MS-01-174.
- For alloy 400 tube fittings, see the *Swagelok Gaugeable Alloy 400/R-405 Mechanically Attached Pipe and Tube Fittings* catalog, MS-02-332.
- For PFA tube fittings, see the *Swagelok PFA Tube Fittings* catalog, MS-01-05.
- For medium-pressure tube fittings, see the *Swagelok Medium-Pressure, Gaugeable Tube Fittings and Adapter Fittings* catalog, MS-02-335.
- For heavy-wall tube fittings, see the *Swagelok High-Pressure Fittings* catalog, MS-01-34.

## Straight Fittings

### Unions



Union, 10

Reducing Union, 11



Bulkhead Union and Bulkhead Reducing Union, 12

### Male Connectors



NPT, 13

ISO/BSP Tapered Thread (RT), 14

ISO/BSP Parallel Thread (RS), 15

ISO/BSP Parallel Thread (RP), 16



Bulkhead NPT, 17



SAE/MS Straight Thread (ST) and Long SAE/MS Straight Thread (ST), 17



O-Seal (SAE/MS Straight Thread and NPT), 18



AN and AN Bulkhead Fitting, 19



10-32 Thread, M5 × 0.8 Thread, and Metric Thread (RS), 20

## Weld Connectors



Tube Socket, 20



Male Pipe, 21

## Female Connectors



NPT, 22

ISO/BSP Tapered Thread (RT), ISO/BSP Parallel Thread (RJ and RP), 23

ISO/BSP Parallel Thread (RG, Gauge), 24



Bulkhead NPT, 24

## Reducers



Reducer, 25

Long Reducer, 26



Bulkhead Reducer, 26

## Port Connectors



Port Connector and Reducing Port Connector, 27

## Contents

### Caps and Plugs



Cap, 28



Plug, 28

### Vent Protectors



Mud Dauber, 28

### 90° Elbows

#### Unions



Union, 29

#### Male



NPT, 30

ISO/BSP Tapered Thread (RT), 31



Reducing, 31



Positionable, ISO/BSP Parallel Thread (PR) and Positionable, SAE/MS Straight Thread (ST), 32

#### Weld



Tube Socket, 33



Male Pipe, 33

#### Female



NPT, 33

### 45° Elbows

#### Male



NPT, 34



Positionable, SAE/MS Straight Thread (ST), 34

#### Tees

#### Unions



Union and Reducing Union, 35

#### Male



Branch, NPT (TTM), 37



Run, NPT (TMT), 37



Positionable Branch, SAE/MS Straight Thread (TTS) and Positionable Branch, ISO/BSP Parallel Thread (TTR), 38



Positionable Run, SAE/MS Straight Thread (TST), 38

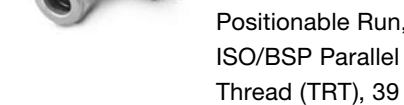

Positionable Run, ISO/BSP Parallel Thread (TRT), 39

### Female



Run, NPT (TFT), 39



Branch, NPT (TTF), 40

### Cross



Union, 40

### Sanitary Flange Fittings



Kwik-Clamp Flange to Swagelok Tube Fitting, 41

### Tube Adapters

Tube Adapter Information, 42

#### Male



NPT and ISO/BSP Tapered Thread (RT), 43



ISO/BSP Parallel Thread (RS and RP), 44



SAE/MS Straight Thread (ST) and O-Seal (SAE/MS Straight Thread), 45



AN Thread, 45



Pipe Weld, 46

## Contents

### Female



NPT and ISO/BSP Tapered Thread (RT), 46

ISO/BSP Parallel Thread (RP and RJ), and ISO/BSP Parallel Thread (RG, Gauge), 47



AN Thread, 47

### Additional Ordering Information, 48

### Replacement Parts

#### Nuts



Female, 50



Knurled Female, 50



Male, 50

#### Ferrules



Front, 51



Back, 51

Nut-Ferrule Set and Package and Ferrule Set and Ferrule-Pak™ Package, 52

### ISO/BSP Parallel Gaskets



Steel (RS Fitting), Copper (RP Fitting), Copper (RG, Gauge Fitting), and PTFE (RJ Fitting), 53

### O-Rings



Buna N (O-Seal Straight Threads and O-Seal Pipe Threads) and Fluorocarbon FKM (ISO/BSP Parallel Threads and SAE/MS Straight Threads), 54

### Tools and Accessories

Hydraulic Swaging Units, 55



Preswaging Tools, 57



Wrenches, 58



Gap Inspection Gauges and Depth Marking Tools, 60



Bulkhead Retainers, 61



Inserts for Soft Plastic Tubing, 61

For liquid leak detectors, lubricants, and sealants, see the Swagelok *Leak Detectors, Lubricants, and Sealants* catalog, MS-01-91.

For tube benders, tube preparation tools, and tube support systems, see the Swagelok *Tubing Tools and Accessories* catalog, MS-01-179.

### Gaugeability, 62

### Installation Instructions, 62

### Bored-Through Fittings

For thermocouples, dip tubes, and heat exchanger tees, 16

### Chromatograph Fittings



See the Swagelok *Gaugeable Chromatograph and Column End Fittings* catalog, MS-02-173.

### Dielectric Fittings



See the Swagelok *Dielectric Fittings* catalog, MS-02-36-SCS.

### Flanges



For ANSI, DIN, and JIS flanges, see the Swagelok *Flange Adapters* catalog, MS-02-200.

### VCO® and VCR® Face Seal Fittings



See the Swagelok *VCR Metal Gasket Face Seal Fittings* and *VCO O-Rings Face Seal Fittings* catalogs, MS-01-24 and MS-01-28.

## The Swagelok Tube Fitting Advantage

### ***“Over 10 000 fittings and not a single leak.”***

That is the message one customer wanted to share, crediting Swagelok components and tube fittings along with Swagelok distributor support, as having played a major role in completing—and obtaining independent, third-party certification for—two 12 000 ton oil rigs.

And that is part of the ongoing story behind the continuous improvement efforts that Swagelok has initiated and sustained since the development and patent of the original two-ferrule tube fitting more than 50 years ago.

Today, as everyone is being called on to “do more with less” and to recognize value, Swagelok continues to improve the leak-tight design of the tube fitting for use in thousands of diverse applications—including research, analytical and process instrumentation, bioprocessing, oil and gas, power, petrochemical, and semiconductor industries—and addressing such critical issues as:

- leakage
- vibration (tube grip)
- thermal shock
- compliance with industry standards
- installation
- corrosion
- intermix/interchange.



### **Leakage**

Excellent gas-tight sealing and consistent reassembly help ensure accurate measurements of process parameters—air, steam, fuel, and water—to keep your plant operating efficiently. Moreover, Swagelok tube fittings minimize fugitive emissions, as well as process fluid leakage and operation costs.

From 1999 through 2004, more than 250 000 fittings in gas service at more than 400 different process installations were leak tested with Swagelok Snoop® liquid leak detector. Contact your authorized Swagelok sales and service representative for more information about Swagelok Energy Emissions Surveys or to schedule a survey.

### **Vibration (Tube Grip)**

The patented case-hardening process and back-ferrule geometry provide excellent vibration fatigue resistance and tube support—even in harsh or stressful environments, such as fuel processing or rotary equipment applications.

Swagelok has conducted rotary flex tests, which show that the Swagelok tube fitting with advanced geometry hinging-colleting back ferrule isolates and protects the stress riser that is generated along the tube during

the gripping part of assembly. The colleting portion of the back ferrule allows more material to contact the tube, for additional support. This colleting action enhances gripping performance and provides both direct and axial support to the gripping function. This design minimizes the effects of bending deflection at the point of grip on the tubing.

Contact your authorized Swagelok representative for more information about vibration test reports.



## Thermal Shock

The elastic, live-loaded two-ferrule design compensates for changes in temperature during system start-up and shutdown and helps eliminate leakage related to rapid thermal expansion or contraction.

Swagelok has conducted tests that demonstrated the capability of Swagelok tube fittings to withstand thermal shock and high temperature.

Contact your authorized Swagelok representative for more information about thermal shock test reports.

## Compliance with Industry Standards

Swagelok Company works with standards organizations around the world to provide you with products that address your needs.

See **Materials**, page 8; **Thread Specifications**, page 8; and **Pressure Ratings**, page 9 section 09, for more information about the specifications to which Swagelok tube fittings are manufactured.

Contact your authorized Swagelok representative for more information about Swagelok tube fitting certifications.



## Installation

The Swagelok tube fitting installation advantages:

- Easy to install
- No torque is transmitted to tubing during installation
- Swagelok gap inspection gauge assures sufficient pull-up upon initial installation.

Swagelok tube fitting components provide exceptional dimensional, metallurgical, and mechanical uniformity that allow predictable, repeatable installation.

Swagelok authorized sales and service centers offer installation training seminars that provide additional information on:

- The requirements for making safe, leak-tight connections
- A variety of tools and accessories designed for use with Swagelok tube fittings.

## Corrosion

Swagelok tube fittings are available in a variety of materials, including controlled-chemistry 316 stainless steel and many other alloys for enhanced corrosion resistance in a variety of applications, including sour gas and subsea systems.

Swagelok has conducted tests in accordance with ASTM B117-95 to evaluate the corrosion resistance of Swagelok tube fittings.

Contact your authorized Swagelok representative for more information about corrosion resistance test reports.

## Intermix/Interchange

This practice can be dangerous. Leak-tight seals that will withstand high pressure, vibration, vacuum, and temperature changes depend on close tolerances and consistent, exacting quality control in conjunction with good design principles. The critical interaction of precision parts is essential for reliability and safety.

Components of other manufacturers may look like Swagelok tube fitting components—but they cannot be manufactured in accordance with Swagelok engineering standards, nor do they benefit from innovations in design and manufacture defined by 36 active Swagelok tube fitting patents issued since 1989.



## Materials

### Materials Standards

| Material              | Bar Stock <sup>①</sup>           | Forgings <sup>②</sup>              |
|-----------------------|----------------------------------|------------------------------------|
| 316 stainless steel   | ASTM A276, ASME SA479, EN 1.4401 | ASTM A182, ASME SA182, EN 1.4401   |
| Alloy 20              | ASTM B473                        | ASTM B462                          |
| Alloy 400             | ASTM B164                        | ASTM B564, ASME SB564              |
| Alloy 600             | ASTM B166, ASME SB166            | ASTM B564, ASME SB564              |
| Alloy 625             | ASTM B446 <sup>③</sup>           | ASTM B564, ASME SB564 <sup>④</sup> |
| Alloy 825             | ASTM B425                        | ASTM B564, ASME SB564              |
| Alloy C-276           | ASTM B574                        | ASTM B564                          |
| Aluminum              | ASTM B211                        | ASTM B247                          |
| Brass                 | ASTM B16, ASTM B453              | ASTM B283                          |
| Carbon steel          | ASTM A108                        | —                                  |
| Nylon                 | ASTM D4066                       | —                                  |
| PFA <sup>⑤</sup>      | —                                | ASTM D3307 Type I                  |
| PTFE                  | ASTM D1710                       | ASTM D3294                         |
| SAF 2507 <sup>⑥</sup> | ASTM A479                        | ASTM A182                          |
| Titanium (grade 4)    | ASTM B348                        | ASTM B381                          |

① Straight fittings and tube adapters.

② Elbows, crosses, and tees.

③ All straight fittings and tube adapters and 1/4 and 3/8 in.; 6 and 10 mm elbows, crosses, and tees.

④ Elbows, crosses, and tees larger than 3/8 in. and 10 mm.

⑤ See the Swagelok *PFA Tube Fittings* catalog, MS-01-05.

⑥ See the Swagelok *Gaugeable SAF 2507 Super Duplex Tube Fittings* catalog, MS-01-174.

### Additional Processing

Fitting bodies are processed for improved performance, as listed below. No additional processing is required for alloy 625, alloy 825, brass, nylon, 316 stainless steel, and PTFE materials.

| Fitting Body Material                       | Process                                      |
|---|--|
| Aluminum                                    | Anodized, hydrocarbon film                   |
| Alloy 400, alloy 20, alloy C-276, alloy 600 | Hydrocarbon film                             |
| Carbon steel (except weld bodies)           | Zinc plating                                 |
| Carbon steel (weld bodies)                  | Hydrocarbon film chemical conversion coating |
| Titanium                                    | Anodized                                     |

■ Over 1 in./25 mm fittings are supplied with a package of fluorinated-base with PTFE and tungsten disulfide lubricant for use in fitting assembly.

■ Over 1 in./25 mm stainless steel fittings use stainless steel ferrules with PFA coating. Applications above 450°F (232°C) **require** silver-plated front ferrules and uncoated back ferrules. To order fittings with silver-plated front ferrules and uncoated back ferrules, add **-BM** to the fitting ordering number.

Example: SS-2400-6-**BM**

■ All carbon steel Swagelok tube fittings are supplied with 316 stainless steel back ferrules.

## Thread Specifications

| Thread Type (End Connection)  | Reference Specification         |
|---|---------------------------------|
| NPT   | ASME B1.20.1, SAE AS71051       |
| ISO/BSP (parallel)<br>(Based on DIN 3852)<br>(Swagelok PR, RP, and RS fittings)   | ISO 228, JIS B0202              |
| ISO/BSP (tapered)<br>(Based on DIN 3852)<br>(Swagelok RT fittings)                | ISO 7, BS EN 10226-1, JIS B0203 |
| ISO/BSP (gauge)<br>(Based on EN 837-1 and 837-3)<br>(Swagelok RG and RJ fittings) | ISO 228, JIS B0202              |
| Unified (SAE)<br>(Swagelok ST fittings)   | ASME B1.1                       |

### Pipe Thread Sealants

A thread sealant should always be used when assembling tapered threads. SWAK<sup>®</sup> anaerobic pipe thread sealant and Swagelok PTFE tape are available. For more information, see the Swagelok *Leak Detectors, Lubricants, and Sealants* catalog, MS-01-91.

### O-Rings

O-seal fittings include a 70 durometer Buna N O-ring. Other straight-thread fittings with O-rings include a 90 durometer fluorocarbon FKM O-ring. Other O-ring materials are available upon request. O-rings are coated with a thin film of silicone-based lubricant. Removal of factory-applied lubricants may alter performance.

### Cleaning and Packaging

Fitting components are cleaned to remove machine oil, grease, and loose particles. For more information, see Swagelok *Standard Cleaning and Packaging (SC-10)*, MS-06-62.

Fittings are available individually bagged; add **CP** to the ordering number.

Example: SS-200-6**CP**

On request, fittings can be cleaned and packaged in accordance with Swagelok *Special Cleaning and Packaging (SC-11)*, MS-06-63, with front ferrules silver plated and Krytox<sup>®</sup> 240 AC applied to the internal surface of the nut. To order, add **BQ** to the ordering number.

Example: SS-400-1-4**BQ**

### Oxygen Service Hazards

For more information about hazards and risks of oxygen-enriched systems, see the Swagelok *Oxygen System Safety* technical report, MS-06-13.

### Alternative Fuels-Type Approval

Stainless steel Swagelok tube fittings used with 316 stainless steel and 316 Ti stainless steel alloy tubing

| Tube OD        | Wall Thickness     |
|----------------|--------------------|
| 3 to 16 mm     | 0.7 to 2.5 mm      |
| 1/8 to 5/8 in. | 0.028 to 0.095 in. |

as shown in the table have been tested to the requirements of ECE R110, EIHP Draft, and ECE R67.



## Metric Swagelok Tube Fittings

Metric tube fittings have a stepped shoulder on the body hex. Shaped fittings, such as elbows, crosses, and tees, are stamped MM for metric tubing and have no step on the forging.

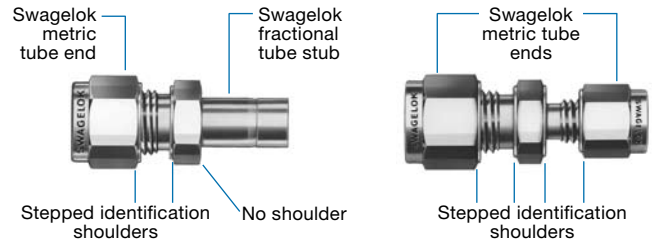

## Pressure Ratings

### Swagelok Tube Fitting Pressure Ratings

Swagelok tube fitting ends are rated to the working pressure of tubing as listed in Swagelok *Tubing Data*, MS-01-107. Careful selection of high-quality tubing is important when installing safe, leak-tight systems.

### Pipe End (NPT and ISO 7) Pressure Ratings Basis

Pressure ratings for fittings with both tube fitting and pipe thread ends are determined by the end connection with the lower pressure rating. The table lists pressure ratings for male and female **tapered pipe thread ends**. For female and male pipe threads to have the same pressure rating in the same nominal pipe size, the female thread would require a heavier wall, resulting in a fitting too large and bulky to be practical.

### Allowable Stress

Stress values are based on ASME Code for Pressure Piping B31.3, Process Piping, at ambient temperature.

| Material | Allowable Stress |      |
|----------|------------------|------|
|          | psi              | bar  |
| 316 SS   | 20 000           | 1378 |
| Brass    | 10 000           | 689  |
| Steel    | 20 000           | 1378 |

### Pressure Ratings

Ratings are based on ASME Code for Pressure Piping B31.3, Process Piping, at ambient temperature.

| NPT/<br>ISO<br>Pipe<br>Size<br>in. | 316 SS and Carbon Steel |     |        |     | Brass |     |        |     |
|------------------------------------|-------------------------|-----|--------|-----|-------|-----|--------|-----|
|                                    | Male                    |     | Female |     | Male  |     | Female |     |
|                                    | psig                    | bar | psig   | bar | psig  | bar | psig   | bar |
| 1/16                               | 11 000                  | 760 | 6700   | 460 | 5500  | 380 | 3300   | 230 |
| 1/8                                | 10 000                  | 690 | 6500   | 440 | 5000  | 340 | 3200   | 220 |
| 1/4                                | 8 000                   | 550 | 6600   | 450 | 4000  | 270 | 3300   | 220 |
| 3/8                                | 7 800                   | 540 | 5300   | 360 | 3900  | 270 | 2600   | 180 |
| 1/2                                | 7 700                   | 530 | 4900   | 330 | 3800  | 260 | 2400   | 160 |
| 3/4                                | 7 300                   | 500 | 4600   | 320 | 3600  | 250 | 2300   | 160 |
| 1                                  | 5 300                   | 370 | 4400   | 300 | 2600  | 180 | 2200   | 150 |
| 1 1/4                              | 6 000                   | 410 | 5000   | 350 | 3000  | 200 | 2500   | 170 |
| 1 1/2                              | 5 000                   | 340 | 4600   | 310 | 2500  | 170 | 2300   | 150 |
| 2                                  | 3 900                   | 270 | 3900   | 270 | 1900  | 130 | 1900   | 130 |

- To determine pressure ratings in accordance with ASME B31.1, Power Piping:
  - carbon steel material—multiply by 0.85.
 Stainless steel and brass material ratings remain the same.
- To determine MPa, multiply bar by 0.10.

### SAE/MS Fittings Pressure Ratings Basis

Pressure ratings are based on SAE J1926/3 at ambient temperature.

| SAE/MS<br>Thread Size | Designator | 316 SS and Carbon Steel |     |              |     |
|-----------------------|------------|-------------------------|-----|--------------|-----|
|                       |            | Nonpositionable         |     | Positionable |     |
|                       |            | psig                    | bar | psig         | bar |
| 5/16-24               | 2ST        | 4568                    | 315 | 4568         | 315 |
| 7/16-20               | 4ST        |                         |     |              |     |
| 1/2-20                | 5ST        |                         |     | 3626         | 250 |
| 9/16-18               | 6ST        |                         |     |              |     |
| 3/4-16                | 8ST        | 3626                    | 250 | 2900         | 200 |
| 7/8-14                | 10ST       |                         |     |              |     |
| 1 1/16-12             | 12ST       |                         |     |              |     |
| 1 3/16-12             | 14ST       | 2900                    | 200 | 2320         | 160 |
| 1 5/16-12             | 16ST       |                         |     |              |     |
| 1 5/8-12              | 20ST       | 2320                    | 160 | 1813         | 125 |
| 1 7/8-12              | 24ST       |                         |     |              |     |
| 2 1/2-12              | 32ST       |                         |     |              |     |

Some fittings with AN, O-seal, and SAE/MS ends may have lower ratings. For more information, contact your authorized Swagelok representative.

### O-Seal Pressure Ratings

Stainless steel and carbon steel O-seal fittings up to 1 in. and 25 mm are rated to 3000 psig (206 bar).

### Positionable, ISO/BSP Parallel Thread (PR) Pressure Ratings

Pressure ratings are at ambient temperature.

| ISO/BSP<br>Male Pipe<br>Size<br>in. | 316 SS and Carbon Steel |     |
|-------------------------------------|-------------------------|-----|
|                                     | psig                    | bar |
| 1/8                                 | 4568                    | 315 |
| 1/4                                 |                         |     |
| 3/8                                 |                         |     |
| 1/2                                 | 2320                    | 160 |
| 3/4                                 |                         |     |
| 1                                   |                         |     |

## Ordering Numbers and Dimensions

- See **How to Order**, below. Minimum order quantities may apply to certain materials and configurations.
- Dimensions are for reference only and are subject to change. Dimensions are shown with Swagelok nuts finger-tight. For Swagelok nut dimensions, see page 50.
- CAD templates are available on [www.swagelok.com](http://www.swagelok.com).

## Straight Fittings

### Unions

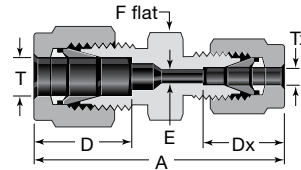
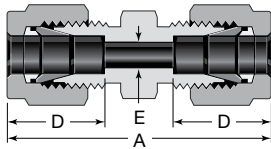

### Union

| Tube OD                | Basic Ordering Number    | Dimensions |      |      |
|------------------------|--------------------------|------------|------|------|
|                        |                          | A          | D    | E    |
| <b>Dimensions, in.</b> |                          |            |      |      |
| 1/16                   | -100-6                   | 0.99       | 0.34 | 0.05 |
| 1/8                    | -200-6                   | 1.40       | 0.50 | 0.09 |
| 3/16                   | -300-6                   | 1.47       | 0.54 | 0.12 |
| 1/4                    | -400-6                   | 1.61       | 0.60 | 0.19 |
| 5/16                   | -500-6                   | 1.69       | 0.64 | 0.25 |
| 3/8                    | -600-6                   | 1.77       | 0.66 | 0.28 |
| 1/2                    | -810-6                   | 2.02       | 0.90 | 0.41 |
| 1/2                    | -810-6-0030 <sup>①</sup> | 4.30       | —    | 0.50 |
| 5/8                    | -1010-6                  | 2.05       | 0.96 |      |
| 3/4                    | -1210-6                  | 2.11       |      | 0.62 |
| 7/8                    | -1410-6                  | 2.17       | 1.02 | 0.72 |
| 1                      | -1610-6                  | 2.55       | 1.23 | 0.88 |
| 1 1/8                  | -1810-6                  |            |      | 0.97 |
| 1 1/4                  | -2000-6                  | 3.63       | 1.62 | 1.09 |
| 1 1/2                  | -2400-6                  | 4.25       | 1.97 | 1.34 |
| 2                      | -3200-6                  | 5.88       | 2.66 | 1.81 |
| <b>Dimensions, mm</b>  |                          |            |      |      |
| 2                      | -2M0-6                   | 35.6       | 12.9 | 1.7  |
| 3                      | -3M0-6                   | 35.3       |      | 2.4  |
| 4                      | -4M0-6                   | 37.3       | 13.7 | 4.8  |
| 6                      | -6M0-6                   | 41.0       | 15.3 |      |
| 8                      | -8M0-6                   | 43.2       | 16.2 | 6.4  |
| 10                     | -10M0-6                  | 46.2       | 17.2 | 7.9  |
| 12                     | -12M0-6                  | 51.2       | 22.8 | 9.5  |
| 14                     | -14M0-6                  | 52.0       | 24.4 | 11.1 |
| 15                     | -15M0-6                  |            |      | 11.9 |
| 16                     | -16M0-6                  |            |      | 12.7 |
| 18                     | -18M0-6                  |            |      | 15.1 |
| 20                     | -20M0-6                  | 55.0       | 26.0 | 15.9 |
| 22                     | -22M0-6                  |            |      | 18.3 |
| 25                     | -25M0-6                  | 65.0       | 31.3 | 21.8 |
| 28                     | -28M0-6                  | 85.0       | 36.6 |      |
| 30                     | -30M0-6                  | 92.7       | 39.6 | 26.2 |
| 32                     | -32M0-6                  | 97.3       | 42.0 | 28.6 |
| 38                     | -38M0-6                  | 114        | 49.4 | 33.7 |
| 50                     | -50M0-6                  | 146        | 65.0 | 45.2 |

<sup>①</sup> Bored through.

### Union (Metric to Fractional)

| Tube OD               |           | Basic Ordering Number | Dimensions |      |      |      |      |      |     |     |
|-----------------------|-----------|-----------------------|------------|------|------|------|------|------|-----|-----|
| T                     | Tx, in.   |                       | A          | D    | Dx   | E    | F    |      |     |     |
| <b>Dimensions, mm</b> |           |                       |            |      |      |      |      |      |     |     |
| 2                     | 1/8       | -2M0-6-2              | 35.2       | 12.9 | 15.3 | 1.7  | 12   |      |     |     |
|                       | 1/4       | -2M0-6-4              | 38.6       |      |      |      | 14   |      |     |     |
| 3                     | 1/8       | -3M0-6-2              | 35.2       | 12.9 | 12.8 | 2.4  | 12   |      |     |     |
| 4                     | 1/8       | -4M0-6-2              | 36.5       | 13.7 | 15.3 | 2.4  | 12   |      |     |     |
|                       | 1/4       | -4M0-6-4              | 39.4       |      |      |      | 14   |      |     |     |
| 6                     | 1/16      | -6M0-6-1              | 34.3       | 15.3 | 8.6  | 1.3  | 14   |      |     |     |
|                       | 1/8       | -6M0-6-2              | 38.5       |      |      |      | 14   |      |     |     |
|                       | 1/4       | -6M0-6-4              | 41.0       |      |      |      | 14   |      |     |     |
|                       | 5/16      | -6M0-6-5              | 42.3       |      |      |      | 14   |      |     |     |
| 8                     | 3/8       | -6M0-6-6              | 43.2       | 16.2 | 15.3 | 4.8  | 14   |      |     |     |
|                       | 1/4       | -8M0-6-4              | 42.3       |      |      |      | 15   |      |     |     |
| 10                    | 3/8       | -8M0-6-6              | 44.3       | 16.2 | 16.9 | 6.4  | 16   |      |     |     |
|                       | 1/8       | -10M0-6-2             | 41.8       |      |      |      | 17.2 | 12.8 | 2.4 |     |
|                       | 1/4       | -10M0-6-4             | 44.5       |      |      |      |      |      |     | 4.8 |
|                       | 5/16      | -10M0-6-5             | 45.1       |      |      |      |      |      |     | 6.4 |
| 3/8                   | -10M0-6-6 | 45.9                  | 7.1        |      |      |      |      |      |     |     |
| 12                    | 1/4       | -12M0-6-4             | 47.0       | 22.8 | 15.3 | 4.8  | 22   |      |     |     |
|                       | 5/16      | -12M0-6-5             | 47.8       |      |      |      |      | 6.4  |     |     |
|                       | 3/8       | -12M0-6-6             | 48.4       |      |      |      |      | 7.1  |     |     |
|                       | 1/2       | -12M0-6-8             | 51.2       |      |      |      |      | 9.5  |     |     |
| 15                    | 1/2       | -15M0-6-8             | 52.0       | 24.4 | 22.8 | 10.3 | 24   |      |     |     |
| 16                    | 5/8       | -16M0-6-10            | 52.0       | 24.4 | 24.4 | 12.7 | 24   |      |     |     |
| 18                    | 3/4       | -18M0-6-12            | 53.5       | 24.4 | 24.4 | 15.1 | 27   |      |     |     |
| 20                    | 1/2       | -20M0-6-8             | 55.0       | 26.0 | 22.8 | 10.3 | 30   |      |     |     |
|                       | 1         | -20M0-6-16            | 62.8       |      |      |      | 15.9 |      |     |     |
| 25                    | 1         | -25M0-6-16            | 65.0       | 31.3 | 31.3 | 21.8 | 35   |      |     |     |

### How to Order

Select a basic ordering number. Example **-100-6**

Add a material designator. Example: **SS-100-6**

| Material  | Designator | Material           | Designator |
|-----------|------------|--------------------|------------|
| 316 SS    | SS         | Alloy C-276        | HC         |
| Aluminum  | A          | Brass              | B          |
| Alloy 20  | C20        | Carbon steel       | S          |
| Alloy 400 | M          | Nylon              | NY         |
| Alloy 600 | INC        | PTFE               | T          |
| Alloy 625 | 625        | Titanium (grade 4) | TI         |
| Alloy 825 | 825        |                    |            |

## Straight Fittings

### Unions

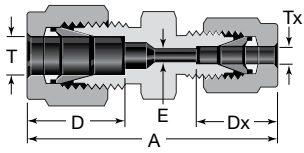

### Reducing Union

| Tube OD                |      | Basic Ordering Number | Dimensions |      |      |      |
|------------------------|------|-----------------------|------------|------|------|------|
| T                      | Tx   |                       | A          | D    | Dx   | E    |
| <b>Dimensions, in.</b> |      |                       |            |      |      |      |
| 1/8                    | 1/16 | -200-6-1              | 1.22       | 0.50 | 0.34 | 0.05 |
| 3/16                   | 1/16 | -300-6-1              | 1.27       | 0.54 | 0.34 | 0.05 |
|                        | 1/8  | -300-6-2              | 1.44       |      | 0.50 | 0.09 |
| 1/4                    | 1/16 | -400-6-1              | 1.35       | 0.60 | 0.34 | 0.05 |
|                        | 1/8  | -400-6-2              | 1.52       |      | 0.50 | 0.09 |
|                        | 3/16 | -400-6-3              | 1.55       |      | 0.54 | 0.12 |
| 5/16                   | 1/8  | -500-6-2              | 1.56       | 0.64 | 0.50 | 0.09 |
|                        | 1/4  | -500-6-4              | 1.66       |      | 0.60 | 0.19 |
| 3/8                    | 1/16 | -600-6-1              | 1.44       | 0.66 | 0.34 | 0.05 |
|                        | 1/8  | -600-6-2              | 1.61       |      | 0.50 | 0.09 |
|                        | 1/4  | -600-6-4              | 1.70       |      | 0.60 | 0.19 |
|                        | 5/16 | -600-6-5              | 1.74       |      | 0.64 | 0.25 |
| 1/2                    | 1/8  | -810-6-2              | 1.78       | 0.90 | 0.50 | 0.09 |
|                        | 1/4  | -810-6-4              | 1.85       |      | 0.60 | 0.19 |
|                        | 3/8  | -810-6-6              | 1.91       |      | 0.66 | 0.28 |
| 5/8                    | 3/8  | -1010-6-6             | 1.94       | 0.96 | 0.66 | 0.28 |
|                        | 1/2  | -1010-6-8             | 2.05       |      | 0.90 | 0.41 |
| 3/4                    | 1/4  | -1210-6-4             | 1.94       | 0.96 | 0.60 | 0.19 |
|                        | 3/8  | -1210-6-6             | 2.00       |      | 0.66 | 0.28 |
|                        | 1/2  | -1210-6-8             | 2.11       |      | 0.90 | 0.41 |
|                        | 5/8  | -1210-6-10            | 2.11       |      | 0.96 | 0.50 |
| 1                      | 1/2  | -1610-6-8             | 2.38       | 1.23 | 0.90 | 0.41 |
|                        | 3/4  | -1610-6-12            |            |      | 0.96 | 0.62 |
| <b>Dimensions, mm</b>  |      |                       |            |      |      |      |
| 3                      | 2    | -3M0-6-2M             | 35.3       | 12.9 | 12.9 | 1.7  |
| 6                      | 2    | -6M0-6-2M             | 38.6       | 15.3 | 12.9 | 1.7  |
|                        | 3    | -6M0-6-3M             | 38.6       |      | 12.9 | 2.4  |
|                        | 4    | -6M0-6-4M             | 39.4       |      | 13.7 | 2.4  |
| 8                      | 6    | -8M0-6-6M             | 42.3       | 16.2 | 15.3 | 4.8  |
| 10                     | 6    | -10M0-6-6M            | 44.5       | 17.2 | 15.3 | 4.8  |
|                        | 8    | -10M0-6-8M            | 45.1       |      | 16.2 | 6.4  |
| 12                     | 6    | -12M0-6-6M            | 47.0       | 22.8 | 15.3 | 4.8  |
|                        | 8    | -12M0-6-8M            | 47.8       |      | 16.2 | 6.4  |
|                        | 10   | -12M0-6-10M           | 48.7       |      | 17.2 | 7.9  |
| 16                     | 10   | -16M0-6-10M           | 45.9       | 24.4 | 17.2 | 7.9  |
|                        | 12   | -16M0-6-12M           | 52.0       |      | 22.8 | 9.5  |
| 18                     | 12   | -18M0-6-12M           | 53.5       | 24.4 | 22.8 | 9.5  |
| 25                     | 18   | -25M0-6-18M           | 61.0       | 31.3 | 24.4 | 15.1 |
|                        | 20   | -25M0-6-20M           | 62.3       |      | 26.0 | 15.9 |
| 30                     | 18   | -30M0-6-18M           | 75.4       | 39.6 | 24.4 | 15.1 |
|                        | 20   | -30M0-6-20M           | 75.4       |      | 26.0 | 15.9 |
|                        | 25   | -30M0-6-25M           | 80.1       |      | 31.3 | 21.8 |
| 32                     | 18   | -32M0-6-18M           | 77.8       | 42.0 | 24.4 | 15.1 |
|                        | 20   | -32M0-6-20M           | 77.8       |      | 26.0 | 15.9 |
|                        | 25   | -32M0-6-25M           | 82.3       |      | 31.3 | 21.8 |
| 38                     | 20   | -38M0-6-20M           | 87.5       | 49.4 | 26.0 | 15.9 |
|                        | 25   | -38M0-6-25M           | 92.0       |      | 31.3 | 21.8 |
|                        | 30   | -38M0-6-30M           | 105        |      | 39.6 | 26.2 |

## Straight Fittings

### Unions

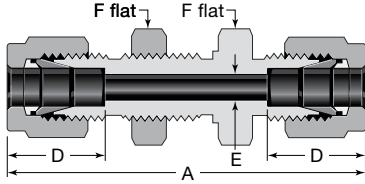

### Bulkhead Union

| Tube OD                | Basic Ordering Number | Dimensions |      |      |        |                 |                     |
|------------------------|-----------------------|------------|------|------|--------|-----------------|---------------------|
|                        |                       | A          | D    | E    | F      | Panel Hole Size | Max Panel Thickness |
| <b>Dimensions, in.</b> |                       |            |      |      |        |                 |                     |
| 1/16                   | -100-61               | 1.24       | 0.34 | 0.05 | 5/16   | 13/64           | 0.12 <sup>①</sup>   |
| 1/8                    | -200-61               | 2.02       | 0.50 | 0.09 | 1/2    | 21/64           | 0.50                |
| 3/16                   | -300-61               | 2.11       | 0.54 | 0.12 | 9/16   | 25/64           |                     |
| 1/4                    | -400-61               | 2.27       | 0.60 | 0.19 | 5/8    | 29/64           | 0.40                |
| 5/16                   | -500-61               | 2.39       | 0.64 | 0.25 | 11/16  | 33/64           | 0.44                |
| 3/8                    | -600-61               | 2.45       | 0.66 | 0.28 | 3/4    | 37/64           |                     |
| 1/2                    | -810-61               | 2.80       | 0.90 | 0.41 | 15/16  | 49/64           | 0.50                |
| 5/8                    | -1010-61              | 2.86       | 0.96 | 0.50 | 1 1/16 | 57/64           |                     |
| 3/4                    | -1210-61              | 3.11       | 0.96 | 0.62 | 1 3/16 | 1 1/64          | 0.66                |
| 1                      | -1610-61              | 3.77       | 1.23 | 0.88 | 1 5/8  | 1 21/64         | 0.75                |
| 1 1/4                  | -2000-61              | 4.85       | 1.62 | 1.09 | 1 7/8  | 1 41/64         |                     |
| 1 1/2                  | -2400-61              | 5.48       | 1.97 | 1.34 | 2 1/4  | 1 61/64         |                     |
| 2                      | -3200-61              | 7.10       | 2.66 | 1.81 | 2 3/4  | 2 41/64         |                     |
| <b>Dimensions, mm</b>  |                       |            |      |      |        |                 |                     |
| 3                      | -3M0-61               | 51.3       | 12.9 | 2.4  | 14     | 8.3             | 12.7                |
| 4                      | -4M0-61               | 53.6       | 13.7 | 2.4  |        | 9.9             |                     |
| 6                      | -6M0-61               | 57.7       | 15.3 | 4.8  | 16     | 11.5            | 10.2                |
| 8                      | -8M0-61               | 61.0       | 16.2 | 6.4  | 18     | 13.1            | 11.2                |
| 10                     | -10M0-61              | 63.7       | 17.2 | 7.9  | 22     | 16.3            |                     |
| 12                     | -12M0-61              | 71.0       | 22.8 | 9.5  | 24     | 19.5            | 12.7                |
| 14                     | -14M0-61              | 72.5       | 24.4 | 11.1 | 27     | 22.5            |                     |
| 15                     | -15M0-61              | 72.5       | 24.4 | 11.9 |        | 22.8            |                     |
| 16                     | -16M0-61              | 72.5       | 24.4 | 12.7 |        |                 |                     |
| 18                     | -18M0-61              | 78.9       | 24.4 | 15.1 | 30     | 26.0            | 16.8                |
| 20                     | -20M0-61              | 84.5       | 26.0 | 15.9 | 35     | 29.0            | 19.0                |
| 25                     | -25M0-61              | 96.0       | 31.3 | 21.8 | 41     | 34.0            |                     |
| 30                     | -30M0-61              | 124        | 39.6 | 26.2 | 50     | 40.5            |                     |
| 32                     | -32M0-61              | 128        | 42.0 | 28.6 |        | 42.5            |                     |
| 38                     | -38M0-61              | 145        | 49.4 | 33.7 | 60     | 50.5            |                     |

① Minimum panel thickness is 0.06 in.

### Bulkhead Reducing Union

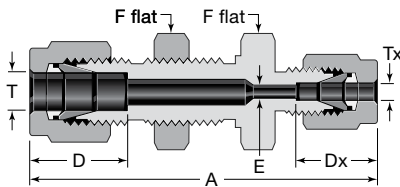

| Tube OD                |      | Basic Ordering Number | Dimensions |      |      |      |       |                 |                     |
|------------------------|------|-----------------------|------------|------|------|------|-------|-----------------|---------------------|
| T                      | Tx   |                       | A          | D    | Dx   | E    | F     | Panel Hole Size | Max Panel Thickness |
| <b>Dimensions, in.</b> |      |                       |            |      |      |      |       |                 |                     |
| 1/8                    | 1/16 | -200-61-1             | 1.85       | 0.50 | 0.34 | 0.05 | 1/2   | 21/64           | 0.50                |
| 1/4                    | 1/8  | -400-61-2             | 2.17       | 0.60 | 0.50 | 0.09 | 5/8   | 29/64           | 0.40                |
| 3/8                    | 1/4  | -600-61-4             | 2.39       | 0.66 | 0.60 | 0.19 | 3/4   | 37/64           | 0.44                |
| 1/2                    | 1/4  | -810-61-4             | 2.63       | 0.90 |      |      | 15/16 | 49/64           | 0.50                |

### Bulkhead Reducing Union (Metric to Fractional)

| Tube OD               |         | Basic Ordering Number | Dimensions |      |      |     |    |                 |                     |
|-----------------------|---------|-----------------------|------------|------|------|-----|----|-----------------|---------------------|
| T                     | Tx, in. |                       | A          | D    | Dx   | E   | F  | Panel Hole Size | Max Panel Thickness |
| <b>Dimensions, mm</b> |         |                       |            |      |      |     |    |                 |                     |
| 6                     | 1/8     | -6M0-61-2             | 55.1       | 15.3 | 12.7 | 2.4 | 16 | 11.5            | 10.2                |

## Straight Fittings

### Male Connectors

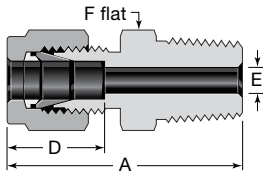

#### NPT

| Tube OD                | NPT Size | Basic Ordering Number | Dimensions |      |                |        |
|------------------------|----------|-----------------------|------------|------|----------------|--------|
|                        |          |                       | A          | D    | E <sup>①</sup> | F      |
| <b>Dimensions, in.</b> |          |                       |            |      |                |        |
| 1/16                   | 1/16     | -100-1-1              | 0.94       | 0.34 | 0.05           | 5/16   |
|                        | 1/8      | -100-1-2              | 1.03       |      |                | 7/16   |
|                        | 1/4      | -100-1-4              | 1.22       |      |                | 9/16   |
| 1/8                    | 1/16     | -200-1-1              | 1.17       | 0.50 | 0.09           | 7/16   |
|                        | 1/8      | -200-1-2              | 1.20       |      |                | 7/16   |
|                        | 1/4      | -200-1-4              | 1.40       |      |                | 9/16   |
|                        | 3/8      | -200-1-6              | 1.41       |      |                | 11/16  |
|                        | 1/2      | -200-1-8              | 1.66       |      |                | 7/8    |
| 3/16                   | 1/8      | -300-1-2              | 1.23       | 0.54 | 0.12           | 7/16   |
|                        | 1/4      | -300-1-4              | 1.43       |      |                | 9/16   |
| 1/4                    | 1/16     | -400-1-1              | 1.29       | 0.60 | 0.12           | 1/2    |
|                        | 1/8      | -400-1-2              | 1.29       |      | 0.19           | 1/2    |
|                        | 1/4      | -400-1-4              | 1.49       |      | 0.19           | 9/16   |
|                        | 3/8      | -400-1-6              | 1.51       |      | 0.19           | 11/16  |
|                        | 1/2      | -400-1-8              | 1.76       |      | 0.19           | 7/8    |
|                        | 3/4      | -400-1-12             | 1.82       |      | 0.19           | 1 1/16 |
| 5/16                   | 1/8      | -500-1-2              | 1.34       | 0.64 | 0.19           | 9/16   |
|                        | 1/4      | -500-1-4              | 1.52       |      | 0.25           | 9/16   |
|                        | 3/8      | -500-1-6              | 1.54       |      | 0.25           | 11/16  |
| 3/8                    | 1/8      | -600-1-2              | 1.39       | 0.66 | 0.19           | 5/8    |
|                        | 1/4      | -600-1-4              | 1.57       |      | 0.28           | 5/8    |
|                        | 3/8      | -600-1-6              | 1.57       |      | 0.28           | 11/16  |
|                        | 1/2      | -600-1-8              | 1.82       |      | 0.28           | 7/8    |
|                        | 3/4      | -600-1-12             | 1.88       |      | 0.28           | 1 1/16 |
|                        | 1        | -600-1-16             | 2.14       |      | 0.28           | 1 3/8  |
| 1/2                    | 1/8      | -810-1-2              | 1.53       | 0.90 | 0.19           | 13/16  |
|                        | 1/4      | -810-1-4              | 1.71       |      | 0.28           | 13/16  |
|                        | 3/8      | -810-1-6              | 1.71       |      | 0.38           | 13/16  |
|                        | 1/2      | -810-1-8              | 1.93       |      | 0.41           | 7/8    |
|                        | 3/4      | -810-1-12             | 1.99       |      | 0.41           | 1 1/16 |
|                        | 1        | -810-1-16             | 2.25       |      | 0.41           | 1 3/8  |
| 5/8                    | 1/4      | -1010-1-4             | 1.74       | 0.96 | 0.28           | 15/16  |
|                        | 3/8      | -1010-1-6             | 1.74       |      | 0.38           | 15/16  |
|                        | 1/2      | -1010-1-8             | 1.93       |      | 0.47           | 15/16  |
|                        | 3/4      | -1010-1-12            | 1.99       |      | 0.50           | 1 1/16 |
| 3/4                    | 3/8      | -1210-1-6             | 1.80       | 0.96 | 0.41           | 1 1/16 |
|                        | 1/2      | -1210-1-8             | 1.99       |      | 0.47           | 1 1/16 |
|                        | 3/4      | -1210-1-12            | 1.99       |      | 0.62           | 1 1/16 |
|                        | 1        | -1210-1-16            | 2.25       |      | 0.62           | 1 3/8  |
| 7/8                    | 1/2      | -1410-1-8             | 1.99       | 1.02 | 0.47           | 1 3/16 |
|                        | 3/4      | -1410-1-12            | 1.99       |      | 0.62           | 1 3/16 |
|                        | 1        | -1410-1-16            | 2.25       |      | 0.72           | 1 3/8  |
| 1                      | 1/2      | -1610-1-8             | 2.26       | 1.23 | 0.47           | 1 3/8  |
|                        | 3/4      | -1610-1-12            | 2.26       |      | 0.62           | 1 3/8  |
|                        | 1        | -1610-1-16            | 2.45       |      | 0.88           | 1 3/8  |
| 1 1/8                  | 1        | -1810-1-16            | 2.45       | 1.23 | 0.88           | 1 5/8  |
| 1 1/4                  | 1        | -2000-1-16            | 3.04       | 1.62 | 0.88           | 1 3/4  |
|                        | 1 1/4    | -2000-1-20            | 3.04       |      | 1.09           | 1 3/4  |
| 1 1/2                  | 1 1/2    | -2400-1-24            | 3.50       | 1.97 | 1.34           | 2 1/8  |
| 2                      | 2        | -3200-1-32            | 4.47       | 2.66 | 1.81           | 2 3/4  |

① The E dimension is the minimum nominal opening. These fittings may have a larger opening at the pipe/straight thread end.

| Tube OD               | NPT Size in. | Basic Ordering Number | Dimensions |      |                |      |
|-----------------------|--------------|-----------------------|------------|------|----------------|------|
|                       |              |                       | A          | D    | E <sup>①</sup> | F    |
| <b>Dimensions, mm</b> |              |                       |            |      |                |      |
| 2                     | 1/8          | -2M0-1-2              | 30.5       | 12.9 | 1.7            | 12   |
| 3                     | 1/8          | -3M0-1-2              | 30.5       | 12.9 | 2.4            | 12   |
|                       | 1/4          | -3M0-1-4              | 35.6       |      |                | 14   |
| 4                     | 1/8          | -4M0-1-2              | 31.2       | 13.7 | 2.4            | 12   |
|                       | 1/4          | -4M0-1-4              | 36.3       |      |                | 14   |
| 6                     | 1/8          | -6M0-1-2              | 32.8       | 15.3 | 4.8            | 14   |
|                       | 1/4          | -6M0-1-4              | 37.9       |      |                | 14   |
|                       | 3/8          | -6M0-1-6              | 38.4       |      |                | 18   |
|                       | 1/2          | -6M0-1-8              | 44.7       |      |                | 22   |
| 8                     | 1/8          | -8M0-1-2              | 34.2       | 16.2 | 4.8            | 15   |
|                       | 1/4          | -8M0-1-4              | 38.7       |      |                | 15   |
|                       | 3/8          | -8M0-1-6              | 39.3       |      |                | 18   |
|                       | 1/2          | -8M0-1-8              | 45.6       |      |                | 22   |
| 10                    | 1/8          | -10M0-1-2             | 36.3       | 17.2 | 4.8            | 18   |
|                       | 1/4          | -10M0-1-4             | 40.9       |      |                | 18   |
|                       | 3/8          | -10M0-1-6             | 40.9       |      |                | 18   |
|                       | 1/2          | -10M0-1-8             | 46.5       |      |                | 22   |
|                       | 3/4          | -10M0-1-12            | 48.0       |      |                | 27   |
| 12                    | 1/8          | -12M0-1-2             | 38.8       | 22.8 | 4.8            | 22   |
|                       | 1/4          | -12M0-1-4             | 43.4       |      |                | 22   |
|                       | 3/8          | -12M0-1-6             | 43.4       |      |                | 22   |
|                       | 1/2          | -12M0-1-8             | 49.0       |      |                | 22   |
|                       | 3/4          | -12M0-1-12            | 50.5       |      |                | 27   |
| 14                    | 1/4          | -14M0-1-4             | 44.1       | 24.4 | 7.1            | 24   |
|                       | 3/8          | -14M0-1-6             | 44.1       |      |                | 9.5  |
|                       | 1/2          | -14M0-1-8             | 49.0       |      |                | 11.1 |
| 15                    | 1/2          | -15M0-1-8             | 49.0       | 24.4 | 11.9           | 24   |
| 16                    | 3/8          | -16M0-1-6             | 44.1       | 24.4 | 9.5            | 24   |
|                       | 1/2          | -16M0-1-8             | 49.0       |      |                | 11.9 |
|                       | 3/4          | -16M0-1-12            | 50.5       |      |                | 12.7 |
| 18                    | 1/2          | -18M0-1-8             | 50.5       | 24.4 | 11.9           | 27   |
|                       | 3/4          | -18M0-1-12            | 50.5       |      |                | 15.1 |
| 20                    | 1/2          | -20M0-1-8             | 52.3       | 26.0 | 11.9           | 30   |
|                       | 3/4          | -20M0-1-12            | 52.3       |      |                | 15.9 |
| 22                    | 3/4          | -22M0-1-12            | 52.3       | 26.0 | 15.9           | 30   |
|                       | 1            | -22M0-1-16            | 57.1       |      |                | 18.3 |
|                       | 1            | -22M0-1-16            | 57.1       |      |                | 18.3 |
| 25                    | 1/2          | -25M0-1-8             | 57.5       | 31.3 | 11.9           | 35   |
|                       | 3/4          | -25M0-1-12            | 57.5       |      |                | 15.9 |
|                       | 1            | -25M0-1-16            | 62.3       |      |                | 21.8 |
| 28                    | 1            | -28M0-1-16            | 72.4       | 36.6 | 21.8           | 41   |
|                       | 1 1/4        | -28M0-1-20            | 73.1       |      |                | 46   |
| 30                    | 1 1/4        | -30M0-1-20            | 77.2       | 39.6 | 26.2           | 46   |
| 32                    | 1 1/4        | -32M0-1-20            | 79.6       | 42.0 | 28.6           | 46   |
| 38                    | 1 1/2        | -38M0-1-24            | 91.6       | 49.4 | 33.7           | 55   |

① The E dimension is the minimum nominal opening. These fittings may have a larger opening at the pipe/straight thread end.

## Straight Fittings

### Male Connectors

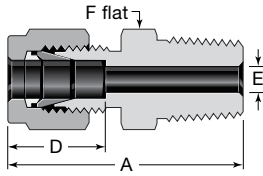

See page 8 for thread specifications.

### ISO/BSP Tapered Thread (RT)

| Tube OD         | ISO Thread Size | Basic Ordering Number | Dimensions |      |                |        |
|-----------------|-----------------|-----------------------|------------|------|----------------|--------|
|                 |                 |                       | A          | D    | E <sup>①</sup> | F      |
| Dimensions, in. |                 |                       |            |      |                |        |
| 1/8             | 1/8             | -200-1-2RT            | 1.20       | 0.50 | 0.09           | 7/16   |
|                 | 1/4             | -200-1-4RT            | 1.40       |      |                | 9/16   |
| 1/4             | 1/8             | -400-1-2RT            | 1.29       | 0.60 | 0.19           | 1/2    |
|                 | 1/4             | -400-1-4RT            | 1.49       |      |                | 9/16   |
|                 | 3/8             | -400-1-6RT            | 1.51       |      |                | 11/16  |
|                 | 1/2             | -400-1-8RT            | 1.76       |      |                | 7/8    |
| 5/16            | 1/8             | -500-1-2RT            | 1.34       | 0.64 | 0.19           | 9/16   |
|                 | 1/4             | -500-1-4RT            | 1.52       |      |                |        |
| 3/8             | 1/8             | -600-1-2RT            | 1.39       | 0.66 | 0.19           | 5/8    |
|                 | 1/4             | -600-1-4RT            | 1.57       |      | 0.28           | 5/8    |
|                 | 3/8             | -600-1-6RT            | 1.57       |      | 0.28           | 11/16  |
|                 | 1/2             | -600-1-8RT            | 1.82       |      | 0.28           | 7/8    |
|                 | 3/4             | -600-1-12RT           | 1.88       |      | 0.28           | 1 1/16 |
| 1/2             | 1/4             | -810-1-4RT            | 1.71       | 0.90 | 0.28           | 13/16  |
|                 | 3/8             | -810-1-6RT            | 1.71       |      | 0.38           | 13/16  |
|                 | 1/2             | -810-1-8RT            | 1.93       |      | 0.41           | 7/8    |
|                 | 3/4             | -810-1-12RT           | 1.99       |      | 0.41           | 1 1/16 |
| 5/8             | 1/2             | -1010-1-8RT           | 1.93       | 0.96 | 0.47           | 15/16  |
| 3/4             | 3/4             | -1210-1-12RT          | 1.99       | 0.96 | 0.62           | 1 1/16 |
|                 | 1               | -1210-1-16RT          | 2.25       |      |                | 1 3/8  |
| 1               | 3/4             | -1610-1-12RT          | 2.26       | 1.23 | 0.63           | 1 3/8  |
|                 | 1               | -1610-1-16RT          | 2.45       |      |                |        |
| 1 1/4           | 1 1/4           | -2000-1-20RT          | 3.04       | 1.62 | 1.09           | 1 3/4  |

① The E dimension is the minimum nominal opening. These fittings may have a larger opening at the pipe/straight thread end.

| Tube OD        | ISO Thread Size, in. | Basic Ordering Number | Dimensions |      |                |    |      |
|----------------|----------------------|-----------------------|------------|------|----------------|----|------|
|                |                      |                       | A          | D    | E <sup>①</sup> | F  |      |
| Dimensions, mm |                      |                       |            |      |                |    |      |
| 2              | 1/8                  | -2M0-1-2RT            | 30.5       | 12.9 | 1.7            | 12 |      |
| 3              | 1/8                  | -3M0-1-2RT            | 30.5       | 12.9 | 2.4            | 12 |      |
|                | 1/4                  | -3M0-1-4RT            | 35.6       |      |                | 14 |      |
| 4              | 1/8                  | -4M0-1-2RT            | 31.2       | 13.7 | 2.4            | 12 |      |
|                | 1/4                  | -4M0-1-4RT            | 36.3       |      |                | 14 |      |
| 6              | 1/8                  | -6M0-1-2RT            | 32.8       | 15.3 | 4.8            | 14 |      |
|                | 1/4                  | -6M0-1-4RT            | 37.9       |      |                | 14 |      |
|                | 3/8                  | -6M0-1-6RT            | 38.4       |      |                | 18 |      |
|                | 1/2                  | -6M0-1-8RT            | 44.7       |      |                | 22 |      |
| 8              | 1/8                  | -8M0-1-2RT            | 34.2       | 16.2 | 4.8            | 15 |      |
|                | 1/4                  | -8M0-1-4RT            | 38.7       |      |                | 15 |      |
|                | 3/8                  | -8M0-1-6RT            | 39.2       |      |                | 18 |      |
|                | 1/2                  | -8M0-1-8RT            | 45.6       |      |                | 22 |      |
| 10             | 1/8                  | -10M0-1-2RT           | 36.3       | 17.2 | 4.8            | 18 |      |
|                | 1/4                  | -10M0-1-4RT           | 40.9       |      |                | 18 |      |
|                | 3/8                  | -10M0-1-6RT           | 40.9       |      |                | 18 |      |
|                | 1/2                  | -10M0-1-8RT           | 46.5       |      |                | 22 |      |
|                | 3/4                  | -10M0-1-12RT          | 48.0       |      |                | 27 |      |
| 12             | 1/4                  | -12M0-1-4RT           | 43.4       | 22.8 | 7.1            | 22 |      |
|                | 3/8                  | -12M0-1-6RT           | 43.4       |      |                | 22 |      |
|                | 1/2                  | -12M0-1-8RT           | 49.0       |      |                | 22 |      |
|                | 3/4                  | -12M0-1-12RT          | 50.5       |      |                | 27 |      |
| 14             | 1/4                  | -14M0-1-4RT           | 44.1       | 24.4 | 7.1            | 24 |      |
|                | 3/8                  | -14M0-1-6RT           | 44.1       |      |                |    | 9.5  |
| 15             | 1/2                  | -15M0-1-8RT           | 49.0       | 24.4 | 11.9           | 24 |      |
| 16             | 1/4                  | -16M0-1-4RT           | 44.1       | 24.4 | 7.1            | 24 |      |
|                | 3/8                  | -16M0-1-6RT           | 44.1       |      |                | 24 |      |
|                | 1/2                  | -16M0-1-8RT           | 49.0       |      |                | 24 |      |
|                | 3/4                  | -16M0-1-12RT          | 50.5       |      |                | 27 |      |
| 18             | 1/2                  | -18M0-1-8RT           | 50.5       | 24.4 | 11.9           | 27 |      |
|                | 3/4                  | -18M0-1-12RT          |            |      |                |    | 15.1 |
| 20             | 1/2                  | -20M0-1-8RT           | 52.3       | 26.0 | 11.9           | 30 |      |
|                | 3/4                  | -20M0-1-12RT          |            |      |                |    | 15.9 |
| 22             | 3/4                  | -22M0-1-12RT          | 52.3       | 26.0 | 15.9           | 30 |      |
|                | 1                    | -22M0-1-16RT          | 57.1       |      |                |    | 18.3 |
| 25             | 1/2                  | -25M0-1-8RT           | 57.5       | 31.3 | 11.9           | 35 |      |
|                | 3/4                  | -25M0-1-12RT          | 57.5       |      |                |    | 15.9 |
|                | 1                    | -25M0-1-16RT          | 62.3       |      |                |    | 21.8 |
| 28             | 1                    | -28M0-1-16RT          | 72.4       | 36.6 | 21.8           | 41 |      |
|                | 1 1/4                | -28M0-1-20RT          | 73.1       |      |                | 46 |      |
| 30             | 1 1/4                | -30M0-1-20RT          | 77.2       | 39.6 | 26.2           | 46 |      |
| 32             | 1 1/4                | -32M0-1-20RT          | 79.6       | 42.0 | 28.6           | 46 |      |
| 38             | 1 1/2                | -38M0-1-24RT          | 91.6       | 49.4 | 33.7           | 55 |      |

① The E dimension is the minimum nominal opening. These fittings may have a larger opening at the pipe/straight thread end.

## Straight Fittings

### Male Connectors

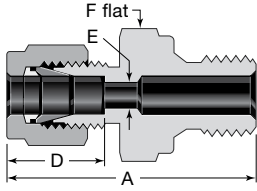

See page 8 for thread specifications.  
ISO/BSP parallel gaskets are available. See page 53.

### ISO/BSP Parallel Thread (RS)

| Tube OD                | ISO Thread Size | Basic Ordering Number | Dimensions |      |                |        |
|------------------------|-----------------|-----------------------|------------|------|----------------|--------|
|                        |                 |                       | A          | D    | E <sup>①</sup> | F      |
| <b>Dimensions, in.</b> |                 |                       |            |      |                |        |
| 1/8                    | 1/8             | -200-1-2RS            | 1.31       | 0.50 | 0.09           | 9/16   |
|                        | 1/4             | -200-1-4RS            | 1.50       |      |                | 3/4    |
|                        | 3/8             | -200-1-6RS            | 1.53       |      |                | 7/8    |
| 1/4                    | 1/8             | -400-1-2RS            | 1.40       | 0.60 | 0.16           | 9/16   |
|                        | 1/4             | -400-1-4RS            | 1.59       |      |                | 3/4    |
|                        | 3/8             | -400-1-6RS            | 1.62       |      |                | 7/8    |
|                        | 1/2             | -400-1-8RS            | 1.70       |      |                | 1 1/16 |
| 3/8                    | 1/8             | -600-1-2RS            | 1.49       | 0.66 | 0.23           | 5/8    |
|                        | 1/4             | -600-1-4RS            | 1.65       |      |                | 3/4    |
|                        | 3/8             | -600-1-6RS            | 1.68       |      |                | 7/8    |
|                        | 1/2             | -600-1-8RS            | 1.76       |      |                | 1 1/16 |
| 1/2                    | 1/4             | -810-1-4RS            | 1.76       | 0.90 | 0.23           | 13/16  |
|                        | 3/8             | -810-1-6RS            | 1.79       |      |                | 7/8    |
|                        | 1/2             | -810-1-8RS            | 1.87       |      |                | 1 1/16 |
| 3/4                    | 1/2             | -1210-1-8RS           | 1.92       | 0.96 | 0.47           | 1 1/16 |
|                        | 3/4             | -1210-1-12RS          | 2.05       |      |                | 1 5/16 |
| 1                      | 1/2             | -1610-1-8RS           | 2.19       | 1.23 | 0.63           | 1 3/8  |
|                        | 3/4             | -1610-1-12RS          | 2.27       |      |                | 1 3/8  |
|                        | 1               | -1610-1-16RS          | 2.35       |      |                | 1 5/8  |

① The E dimension is the minimum nominal opening. These fittings may have a larger opening at the pipe/straight thread end.

| Tube OD               | ISO Thread Size, in. | Basic Ordering Number | Dimensions |      |                |    |
|-----------------------|----------------------|-----------------------|------------|------|----------------|----|
|                       |                      |                       | A          | D    | E <sup>①</sup> | F  |
| <b>Dimensions, mm</b> |                      |                       |            |      |                |    |
| 2                     | 1/8                  | -2M0-1-2RS            | 33.3       | 12.9 | 1.7            | 14 |
| 3                     | 1/8                  | -3M0-1-2RS            | 33.3       | 12.9 | 2.4            | 14 |
|                       | 1/4                  | -3M0-1-4RS            | 38.1       |      |                | 19 |
| 4                     | 1/8                  | -4M0-1-2RS            | 34.0       | 13.7 | 2.4            | 14 |
| 6                     | 1/8                  | -6M0-1-2RS            | 35.6       | 15.3 | 4.0            | 14 |
|                       | 1/4                  | -6M0-1-4RS            | 40.4       |      |                | 19 |
|                       | 3/8                  | -6M0-1-6RS            | 41.1       |      |                | 22 |
|                       | 1/2                  | -6M0-1-8RS            | 43.2       |      |                | 27 |
| 8                     | 1/8                  | -8M0-1-2RS            | 36.6       | 16.2 | 4.0            | 15 |
|                       | 1/4                  | -8M0-1-4RS            | 41.4       |      |                | 19 |
|                       | 3/8                  | -8M0-1-6RS            | 42.2       |      |                | 22 |
|                       | 1/2                  | -8M0-1-8RS            | 44.2       |      |                | 27 |
| 10                    | 1/4                  | -10M0-1-4RS           | 42.2       | 17.2 | 5.9            | 19 |
|                       | 3/8                  | -10M0-1-6RS           | 42.9       |      |                | 22 |
|                       | 1/2                  | -10M0-1-8RS           | 45.0       |      |                | 27 |
| 12                    | 1/4                  | -12M0-1-4RS           | 44.5       | 22.8 | 5.9            | 22 |
|                       | 3/8                  | -12M0-1-6RS           | 45.5       |      |                | 22 |
|                       | 1/2                  | -12M0-1-8RS           | 47.5       |      |                | 27 |
|                       | 3/4                  | -12M0-1-12RS          | 52.1       |      |                | 35 |
| 14                    | 3/8                  | -14M0-1-6RS           | 43.9       | 24.4 | 7.9            | 24 |
|                       | 1/2                  | -14M0-1-8RS           | 47.5       |      |                | 27 |
| 15                    | 3/8                  | -15M0-1-6RS           | 45.5       | 24.4 | 7.9            | 24 |
|                       | 1/2                  | -15M0-1-8RS           | 47.5       |      |                | 27 |
|                       | 3/4                  | -15M0-1-12RS          | 52.8       |      |                | 35 |
| 16                    | 3/8                  | -16M0-1-6RS           | 45.5       | 24.4 | 7.9            | 24 |
|                       | 1/2                  | -16M0-1-8RS           | 47.5       |      |                | 27 |
|                       | 3/4                  | -16M0-1-12RS          | 52.8       |      |                | 35 |
| 18                    | 1/2                  | -18M0-1-8RS           | 48.8       | 24.4 | 11.9           | 27 |
|                       | 3/4                  | -18M0-1-12RS          | 52.1       |      |                | 35 |
| 20                    | 1/2                  | -20M0-1-8RS           | 50.5       | 26.0 | 11.9           | 30 |
|                       | 3/4                  | -20M0-1-12RS          | 52.6       |      |                | 35 |
| 22                    | 3/4                  | -22M0-1-12RS          | 52.6       | 26.0 | 15.9           | 35 |
|                       | 1                    | -22M0-1-16RS          | 54.9       |      |                | 41 |
| 25                    | 3/4                  | -25M0-1-12RS          | 57.7       | 31.3 | 15.9           | 35 |
|                       | 1                    | -25M0-1-16RS          | 59.7       |      |                | 41 |
| 28                    | 1                    | -28M0-1-16RS          | 69.9       | 36.6 | 19.8           | 41 |
|                       | 1 1/4                | -28M0-1-20RS          | 72.9       |      |                | 50 |
| 30                    | 1 1/4                | -30M0-1-20RS          | 76.7       | 39.6 | 26.2           | 50 |
| 32                    | 1 1/4                | -32M0-1-20RS          | 79.2       | 42.0 | 28.6           | 50 |
| 38                    | 1 1/2                | -38M0-1-24RS          | 90.9       | 49.4 | 31.8           | 55 |

① The E dimension is the minimum nominal opening. These fittings may have a larger opening at the pipe/straight thread end.

## Straight Fittings

### Male Connectors

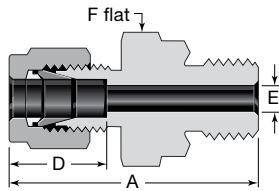

See page 8 for thread specifications.  
ISO/BSP parallel gaskets are available. See page 53.

### ISO/BSP Parallel Thread (RP)

| Tube OD         | ISO Thread Size | Basic Ordering Number | Dimensions |      |                |        |
|-----------------|-----------------|-----------------------|------------|------|----------------|--------|
|                 |                 |                       | A          | D    | E <sup>①</sup> | F      |
| Dimensions, in. |                 |                       |            |      |                |        |
| 1/8             | 1/8             | -200-1-2RP            | 1.31       | 0.50 | 0.09           | 9/16   |
|                 | 1/4             | -200-1-4RP            | 1.50       |      |                | 3/4    |
| 1/4             | 1/8             | -400-1-2RP            | 1.40       | 0.60 | 0.16           | 9/16   |
|                 | 1/4             | -400-1-4RP            | 1.59       |      |                | 3/4    |
| 1/2             | 3/8             | -810-1-6RP            | 1.79       | 0.90 | 0.31           | 7/8    |
|                 | 1/2             | -810-1-8RP            | 1.87       |      |                | 1 1/16 |
| 3/4             | 1/2             | -1210-1-8RP           | 1.92       | 0.96 | 0.47           | 1 1/16 |
|                 | 3/4             | -1210-1-12RP          | 2.05       |      |                | 1 5/16 |
| 1               | 1               | -1610-1-16RP          | 2.35       | 1.23 | 0.78           | 1 5/8  |

① The E dimension is the minimum nominal opening. These fittings may have a larger opening at the pipe/straight thread end.

| Tube OD        | ISO Thread Size, in. | Basic Ordering Number | Dimensions |      |                |    |
|----------------|----------------------|-----------------------|------------|------|----------------|----|
|                |                      |                       | A          | D    | E <sup>①</sup> | F  |
| Dimensions, mm |                      |                       |            |      |                |    |
| 3              | 1/8                  | -3M0-1-2RP            | 33.3       | 12.9 | 2.4            | 14 |
|                | 1/4                  | -3M0-1-4RP            | 38.1       |      |                | 19 |
| 4              | 1/8                  | -4M0-1-2RP            | 34.0       | 13.7 | 2.4            | 14 |
| 6              | 1/8                  | -6M0-1-2RP            | 35.6       | 15.3 | 4.0            | 14 |
|                | 1/4                  | -6M0-1-4RP            | 40.4       |      |                | 19 |
|                | 3/8                  | -6M0-1-6RP            | 41.2       |      |                | 22 |
|                | 1/2                  | -6M0-1-8RP            | 43.2       |      |                | 27 |
| 8              | 1/8                  | -8M0-1-2RP            | 36.5       | 16.2 | 4.0            | 15 |
|                | 1/4                  | -8M0-1-4RP            | 41.3       |      |                | 19 |
|                | 3/8                  | -8M0-1-6RP            | 41.9       |      |                | 22 |
|                | 1/2                  | -8M0-1-8RP            | 44.1       |      |                | 27 |
| 10             | 1/4                  | -10M0-1-4RP           | 42.2       | 17.2 | 5.9            | 19 |
|                | 3/8                  | -10M0-1-6RP           | 42.9       |      |                | 22 |
|                | 1/2                  | -10M0-1-8RP           | 45.0       |      |                | 27 |
| 12             | 1/4                  | -12M0-1-4RP           | 45.4       | 22.8 | 5.9            | 22 |
|                | 3/8                  | -12M0-1-6RP           | 45.4       |      |                | 22 |
|                | 1/2                  | -12M0-1-8RP           | 47.5       |      |                | 27 |
|                | 3/4                  | -12M0-1-12RP          | 52.1       |      |                | 35 |
| 15             | 1/2                  | -15M0-1-8RP           | 47.5       | 24.4 | 11.9           | 27 |
| 16             | 3/8                  | -16M0-1-6RP           | 45.4       | 24.4 | 7.9            | 24 |
|                | 1/2                  | -16M0-1-8RP           | 47.5       |      |                | 27 |
| 18             | 1/2                  | -18M0-1-8RP           | 49.0       | 24.4 | 11.9           | 27 |
|                | 3/4                  | -18M0-1-12RP          | 52.3       |      |                | 35 |
| 20             | 1/2                  | -20M0-1-8RP           | 50.5       | 26.0 | 11.9           | 30 |
|                | 3/4                  | -20M0-1-12RP          | 52.5       |      |                | 35 |
| 22             | 3/4                  | -22M0-1-12RP          | 52.8       | 26.0 | 15.9           | 35 |
|                | 1                    | -22M0-1-16RP          | 54.5       |      |                | 41 |
|                | 1                    | -22M0-1-20RP          | 57.8       |      |                | 41 |
| 25             | 3/4                  | -25M0-1-12RP          | 57.8       | 31.3 | 15.9           | 35 |
|                | 1                    | -25M0-1-16RP          | 59.8       |      |                | 41 |
| 28             | 1                    | -28M0-1-16RP          | 69.8       | 36.6 | 19.8           | 41 |
|                | 1 1/4                | -28M0-1-20RP          | 72.9       |      |                | 50 |
| 30             | 1 1/4                | -30M0-1-20RP          | 76.8       | 39.6 | 26.2           | 50 |
| 32             | 1 1/4                | -32M0-1-20RP          | 79.2       | 42.0 | 28.6           | 50 |
| 38             | 1 1/2                | -38M0-1-24RP          | 92.1       | 49.4 | 31.8           | 55 |

① The E dimension is the minimum nominal opening. These fittings may have a larger opening at the pipe/straight thread end.

### Bored-Through Fittings for Thermocouples, Dip Tubes, and Heat Exchanger Tees

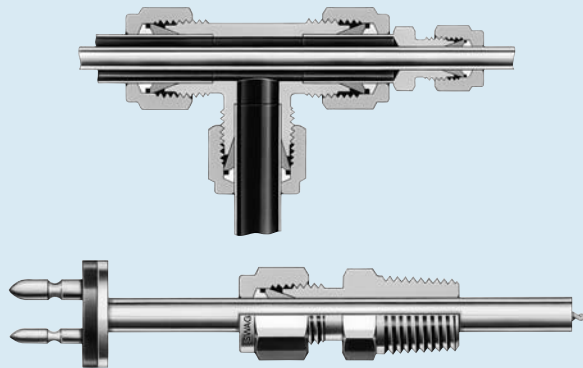

Swagelok bored-through male connectors accommodate thermocouples or dip tubes. Most male connectors are available as a bored-through fitting, but male connectors whose pipe thread end is small relative to the tube fitting end—such as **-600-1-2** or **-8M0-1-2RT**—cannot be bored through.

Swagelok bored-through reducers and standard Swagelok tees can be used to create a heat exchanger tee.

To order bored-through fittings, add **BT** to the ordering number.

Example: SS-400-1-4BT

**Bored-through fittings have a reduced pressure rating. Contact your authorized Swagelok representative for details.**



## Straight Fittings

### Male Connectors

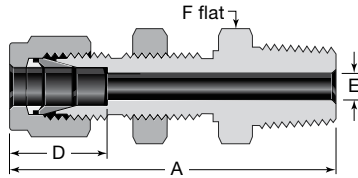

### Bulkhead NPT

| Tube OD                | NPT Size in. | Basic Ordering Number | Dimensions |      |                |        |                 |                     |
|------------------------|--------------|-----------------------|------------|------|----------------|--------|-----------------|---------------------|
|                        |              |                       | A          | D    | E <sup>①</sup> | F      | Panel Hole Size | Max Panel Thickness |
| <b>Dimensions, in.</b> |              |                       |            |      |                |        |                 |                     |
| 1/8                    | 1/8          | -200-11-2             | 1.83       | 0.50 | 0.09           | 1/2    | 21/64           | 0.50                |
| 1/4                    | 1/8          | -400-11-2             | 1.95       | 0.60 | 0.19           | 5/8    | 29/64           | 0.40                |
|                        | 1/4          | -400-11-4             | 2.13       |      |                |        |                 |                     |
| 3/8                    | 1/4          | -600-11-4             | 2.26       | 0.66 | 0.28           | 3/4    | 37/64           | 0.44                |
|                        | 3/8          | -600-11-6             | 2.26       |      |                |        |                 |                     |
|                        | 1/2          | -600-11-8             | 2.51       |      |                |        |                 |                     |
| 1/2                    | 3/8          | -810-11-6             | 2.49       | 0.90 | 0.38           | 15/16  | 49/64           | 0.50                |
|                        | 1/2          | -810-11-8             | 2.71       |      |                |        |                 |                     |
| 3/4                    | 3/4          | -1210-11-12           | 3.00       | 0.96 | 0.62           | 1 3/16 | 1 1/64          | 0.66                |
| 1                      | 1            | -1610-11-16           | 3.67       | 1.23 | 0.88           | 1 5/8  | 1 21/64         | 0.75                |
| <b>Dimensions, mm</b>  |              |                       |            |      |                |        |                 |                     |
| 6                      | 1/8          | -6M0-11-2             | 49.5       | 15.3 | 4.8            | 16     | 11.5            | 10.2                |
|                        | 1/4          | -6M0-11-4             | 53.6       |      |                |        |                 |                     |
| 12                     | 1/2          | -12M0-11-8            | 68.8       | 22.8 | 9.5            | 24     | 19.5            | 12.7                |

① The E dimension is the minimum nominal opening. These fittings may have a larger opening at the pipe/straight thread end.

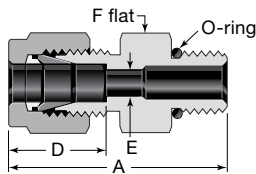

Adapts to SAE J1926/1 and ISO 11926-1 straight thread boss.

### SAE/MS Straight Thread (ST)

| Tube OD                | SAE/MS Thread Size | Basic Ordering Number | Dimensions |      |                |        |
|------------------------|--------------------|-----------------------|------------|------|----------------|--------|
|                        |                    |                       | A          | D    | E <sup>①</sup> | F      |
| <b>Dimensions, in.</b> |                    |                       |            |      |                |        |
| 1/8                    | 5/16-24            | -200-1-2ST            | 1.18       | 0.50 | 0.09           | 7/16   |
|                        | 7/16-20            | -200-1-4ST            | 1.24       |      |                | 9/16   |
|                        | 9/16-18            | -200-1-6ST            | 1.31       |      |                | 11/16  |
| 1/4                    | 5/16-24            | -400-1-2ST            | 1.27       | 0.60 | 0.09           | 1/2    |
|                        | 7/16-20            | -400-1-4ST            | 1.34       |      |                | 9/16   |
|                        | 9/16-18            | -400-1-6ST            | 1.40       |      |                | 11/16  |
|                        | 3/4-16             | -400-1-8ST            | 1.48       |      |                | 7/8    |
|                        | 7/8-14             | -400-1-10ST           | 1.60       |      |                | 1      |
|                        |                    |                       |            |      |                |        |
| 5/16                   | 1/2-20             | -500-1-5ST            | 1.37       | 0.64 | 0.25           | 5/8    |
| 3/8                    | 7/16-20            | -600-1-4ST            | 1.40       | 0.66 | 0.18           | 5/8    |
|                        | 9/16-18            | -600-1-6ST            | 1.46       |      |                | 11/16  |
|                        | 3/4-16             | -600-1-8ST            | 1.54       |      |                | 7/8    |
|                        | 7/8-14             | -600-1-10ST           | 1.66       |      |                | 1      |
| 1/2                    | 9/16-18            | -810-1-6ST            | 1.54       | 0.90 | 0.28           | 13/16  |
|                        | 3/4-16             | -810-1-8ST            | 1.65       |      |                | 7/8    |
|                        | 7/8-14             | -810-1-10ST           | 1.77       |      |                | 1      |
|                        | 1 1/16-12          | -810-1-12ST           | 1.93       |      |                | 1 1/4  |
| 5/8                    | 3/4-16             | -1010-1-8ST           | 1.65       | 0.96 | 0.42           | 15/16  |
|                        | 7/8-14             | -1010-1-10ST          | 1.78       |      |                | 1      |
| 3/4                    | 3/4-16             | -1210-1-8ST           | 1.81       | 0.96 | 0.42           | 1 1/16 |
|                        | 1 1/16-12          | -1210-1-12ST          | 1.93       |      |                | 1 1/4  |
|                        | 1 5/16-12          | -1210-1-16ST          | 1.96       |      |                | 1 1/2  |
| 7/8                    | 1 3/16-12          | -1410-1-14ST          | 1.93       | 1.02 | 0.72           | 1 3/8  |
|                        |                    |                       |            |      |                |        |
| 1                      | 1 1/16-12          | -1610-1-12ST          | 2.10       | 1.23 | 0.66           | 1 3/8  |
|                        | 1 5/16-12          | -1610-1-16ST          | 2.14       |      |                | 1 1/2  |
| 1 1/4                  | 1 5/8-12           | -2000-1-20ST          | 2.69       | 1.62 | 1.09           | 1 7/8  |
| 1 1/2                  | 1 7/8-12           | -2400-1-24ST          | 3.06       | 1.97 | 1.34           | 2 1/8  |
| 2                      | 2 1/2-12           | -3200-1-32ST          | 4.00       | 2.66 | 1.81           | 2 3/4  |

| Tube OD               | SAE/MS Thread Size | Basic Ordering Number | Dimensions |      |                |    |
|-----------------------|--------------------|-----------------------|------------|------|----------------|----|
|                       |                    |                       | A          | D    | E <sup>①</sup> | F  |
| <b>Dimensions, mm</b> |                    |                       |            |      |                |    |
| 6                     | 9/16-18            | -6M0-1-6ST            | 35.6       | 15.3 | 4.8            | 18 |
| 10                    | 9/16-18            | -10M0-1-6ST           | 37.3       | 17.2 | 7.1            | 22 |
|                       | 3/4-16             | -10M0-1-8ST           | 39.4       |      |                |    |
| 12                    | 7/16-20            | -12M0-1-4ST           | 40.6       | 22.8 | 5.2            | 22 |
|                       | 9/16-18            | -12M0-1-6ST           | 39.9       |      |                |    |
|                       | 3/4-16             | -12M0-1-8ST           | 41.9       |      |                |    |

① The E dimension is the minimum nominal opening. These fittings may have a larger opening at the pipe/straight thread end.

### Long SAE/MS Straight Thread (ST)

| Tube OD                | SAE/MS Thread Size | Basic Ordering Number | Dimensions |      |                |      |
|------------------------|--------------------|-----------------------|------------|------|----------------|------|
|                        |                    |                       | A          | D    | E <sup>①</sup> | F    |
| <b>Dimensions, in.</b> |                    |                       |            |      |                |      |
| 1/4                    | 7/16-20            | -400-1L-4ST           | 2.26       | 0.60 | 0.19           | 9/16 |
| 1/2                    | 3/4-16             | -810-1L-8ST           | 3.01       | 0.90 | 0.41           | 7/8  |

① The E dimension is the minimum nominal opening. These fittings may have a larger opening at the pipe/straight thread end.

① The E dimension is the minimum nominal opening. These fittings may have a larger opening at the pipe/straight thread end.

## Straight Fittings

### Male Connectors

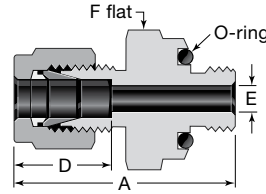
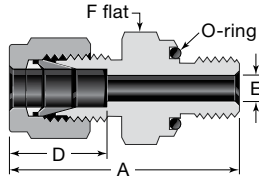

#### O-Seal (SAE/MS Straight Thread)

| Tube OD         | SAE/MS Thread Size | Basic Ordering Number | Dimensions |      |                |       |
|-----------------|--------------------|-----------------------|------------|------|----------------|-------|
|                 |                    |                       | A          | D    | E <sup>①</sup> | F     |
| Dimensions, in. |                    |                       |            |      |                |       |
| 1/16            | 5/16-24            | -100-1-OR             | 1.05       | 0.34 | 0.05           | 9/16  |
| 1/8             | 5/16-24            | -200-1-OR             | 1.29       | 0.50 | 0.09           | 9/16  |
| 3/16            | 3/8-24             | -300-1-OR             | 1.35       | 0.54 | 0.12           | 5/8   |
| 1/4             | 7/16-20            | -400-1-OR             | 1.51       | 0.60 | 0.19           | 3/4   |
| 5/16            | 1/2-20             | -500-1-OR             | 1.60       | 0.64 | 0.25           | 7/8   |
| 3/8             | 9/16-18            | -600-1-OR             | 1.67       | 0.66 | 0.28           | 15/16 |
| 1/2             | 3/4-16             | -810-1-OR             | 1.81       | 0.90 | 0.41           | 1 1/8 |
| 3/4             | 1 1/16-12          | -1210-1-OR            | 2.06       | 0.96 | 0.62           | 1 1/2 |
| 1               | 1 5/16-12          | -1610-1-OR            | 2.29       | 1.23 | 0.88           | 1 3/4 |

① The E dimension is the minimum nominal opening. These fittings may have a larger opening at the pipe/straight thread end.

#### O-Seal (NPT)

| Tube OD         | NPT Size | Basic Ordering Number | Dimensions |      |                |        |
|-----------------|----------|-----------------------|------------|------|----------------|--------|
|                 |          |                       | A          | D    | E <sup>①</sup> | F      |
| Dimensions, in. |          |                       |            |      |                |        |
| 1/8             | 1/8      | -200-1-2-OR           | 1.29       | 0.50 | 0.09           | 3/4    |
| 1/4             | 1/8      | -400-1-2-OR           | 1.38       | 0.60 | 0.19           | 3/4    |
|                 | 1/4      | -400-1-4-OR           | 1.51       |      |                | 15/16  |
| 3/8             | 1/4      | -600-1-4-OR           | 1.57       | 0.66 | 0.28           | 15/16  |
|                 | 3/8      | -600-1-6-OR           | 1.63       |      |                | 1 1/8  |
|                 | 1/2      | -600-1-8-OR           | 1.85       |      |                | 1 5/16 |
| 1/2             | 1/2      | -810-1-8-OR           | 1.96       | 0.90 | 0.41           | 1 5/16 |

① The E dimension is the minimum nominal opening. These fittings may have a larger opening at the pipe/straight thread end.

### Mounting Dimensions for O-Seal Fittings

For a raised surface, see Fig. 1. The minimum diameter allows metal-to-metal contact outside of the O-ring sealing diameter to prevent O-ring extrusion.

For a recessed hole that allows the round shoulder of the O-seal fitting into the recess, see Fig. 2.

For a recessed hole that allows the hex of the O-seal fitting into the recess, see Fig. 3.

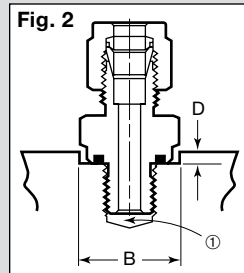
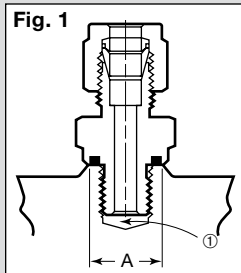

① Allow clearance for full thread.

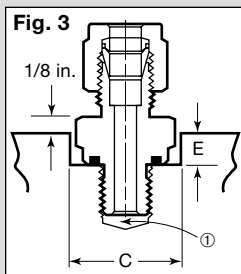

| SAE/MS Thread Size | NPT Size | A Min Dia | B Min Dia | C Min Dia | D Max Depth | E Max Depth |
|--------------------|----------|-----------|-----------|-----------|-------------|-------------|
| Dimensions, in.    |          |           |           |           |             |             |
| 5/16-24            | —        | 0.50      | 0.59      | 0.66      | 0.09        | 0.16        |
| 5/16-24            |          |           |           |           |             | 0.22        |
| —                  | 1/8      | 0.69      | 0.78      | 0.88      | 0.16        | 0.28        |
| 3/8-24             | —        | 0.56      | 0.66      | 0.75      | 0.09        | 0.22        |
| 7/16-20            | —        | 0.69      | 0.78      | 0.88      | 0.16        | 0.28        |
| —                  | 1/8      |           |           |           |             |             |
| —                  | 1/4      | 0.87      | 0.97      | 1.09      |             | 0.31        |
| 1/2-20             | —        | 0.75      | 0.91      | 1.03      |             |             |
| 9/16-18            | —        | 0.81      | 0.97      | 1.09      |             | 0.34        |
| —                  | 1/4      | 0.87      |           |           |             |             |
| —                  | 3/8      | 1.00      | 1.16      | 1.31      | 0.22        | 0.44        |
| —                  | 1/2      | 1.22      | 1.34      | 1.53      |             |             |
| 3/4-16             | —        | 1.00      | 1.16      | 1.31      | 0.16        | 0.34        |
| —                  | 1/2      | 1.22      | 1.34      | 1.53      | 0.44        |             |
| 1 1/16-12          | —        | 1.41      | 1.53      | 1.75      |             | 0.22        |
| 1 5/16-12          | —        | 1.69      | 1.78      | 2.03      | 0.56        |             |

## Straight Fittings

### Male Connectors

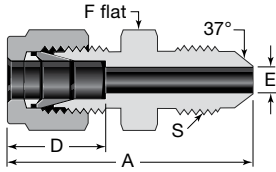

### AN Fitting

| Tube OD                | AN Tube Flare Size | Basic Ordering Number | Dimensions |      |                |       |                |
|------------------------|--------------------|-----------------------|------------|------|----------------|-------|----------------|
|                        |                    |                       | A          | D    | E <sup>①</sup> | F     | S              |
| <b>Dimensions, in.</b> |                    |                       |            |      |                |       |                |
| 1/16                   | 1/8                | -100-6-2AN            | 1.07       | 0.34 | 0.05           | 7/16  | 5/16-24UNJF-3  |
| 1/8                    | 1/8                | -200-6-2AN            | 1.27       | 0.50 | 0.06           | 7/16  | 5/16-24UNJF-3  |
|                        | 1/4                | -200-6-4AN            | 1.38       |      | 0.09           | 1/2   | 7/16-20UNJF-3  |
| 1/4                    | 1/4                | -400-6-4AN            | 1.48       | 0.60 | 0.17           | 1/2   | 7/16-20UNJF-3  |
| 5/16                   | 5/16               | -500-6-5AN            | 1.51       | 0.64 | 0.23           | 9/16  | 1/2-20UNJF-3   |
| 3/8                    | 1/4                | -600-6-4AN            | 1.56       | 0.66 | 0.17           | 5/8   | 7/16-20UNJF-3  |
|                        | 3/8                | -600-6-6AN            |            |      | 0.28           |       | 9/16-18UNJF-3  |
| 1/2                    | 1/2                | -810-6-8AN            | 1.81       | 0.90 | 0.39           | 13/16 | 3/4-16UNJF-3   |
| 3/4                    | 3/4                | -1210-6-12AN          | 2.10       | 0.96 | 0.61           | 1 1/8 | 1 1/16-12UNJ-3 |
| 1                      | 1                  | -1610-6-16AN          | 2.42       | 1.23 | 0.84           | 1 3/8 | 1 5/16-12UNJ-3 |

① The E dimension is the minimum nominal opening. These fittings may have a larger opening at the pipe/straight thread end.

### AN Bulkhead Fitting

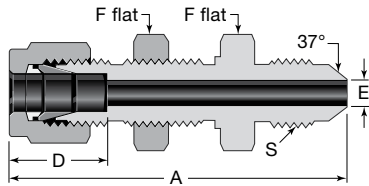

| Tube OD                | AN Tube Flare Size | Basic Ordering Number | Dimensions |      |      |        |                | Panel Hole Size | Max Panel Thickness |
|------------------------|--------------------|-----------------------|------------|------|------|--------|----------------|-----------------|---------------------|
|                        |                    |                       | A          | D    | E    | F      | S              |                 |                     |
| <b>Dimensions, in.</b> |                    |                       |            |      |      |        |                |                 |                     |
| 1/4                    | 1/4                | -400-61-4AN           | 2.12       | 0.60 | 0.17 | 5/8    | 7/16-20UNJF-3  | 29/64           | 0.40                |
| 3/8                    | 3/8                | -600-61-6AN           | 2.25       | 0.66 | 0.28 | 3/4    | 9/16-18UNJF-3  | 37/64           | 0.44                |
| 1/2                    | 1/2                | -810-61-8AN           | 2.59       | 0.90 | 0.39 | 15/16  | 3/4-16UNJF-3   | 49/64           | 0.50                |
| 3/4                    | 3/4                | -1210-61-12AN         | 3.11       | 0.96 | 0.61 | 1 3/16 | 1 1/16-12UNJ-3 | 1 1/64          | 0.66                |
| 1                      | 1                  | -1610-61-16AN         | 3.64       | 1.23 | 0.84 | 1 5/8  | 1 5/16-12UNJ-3 | 1 21/64         | 0.75                |

## Straight Fittings

### Male Connectors

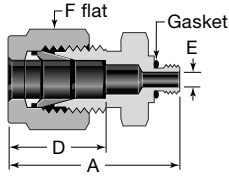

### 10-32 Thread

| Tube OD                | Basic Ordering Number | Dimensions |      |                |      |
|------------------------|-----------------------|------------|------|----------------|------|
|                        |                       | A          | D    | E <sup>①</sup> | F    |
| <b>Dimensions, in.</b> |                       |            |      |                |      |
| 1/8                    | -200-1-0157           | 0.95       | 0.50 | 0.09           | 7/16 |
| 1/4                    | -400-1-0256           | 1.08       | 0.60 |                | 9/16 |

① The E dimension is the minimum nominal opening. These fittings may have a larger opening at the pipe/straight thread end.

### M5 × 0.8 Thread

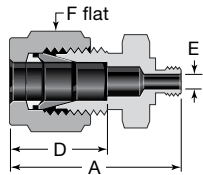

| Tube OD               | Basic Ordering Number | Dimensions |      |                |    |
|-----------------------|-----------------------|------------|------|----------------|----|
|                       |                       | A          | D    | E <sup>①</sup> | F  |
| <b>Dimensions, mm</b> |                       |            |      |                |    |
| 6                     | -6M0-1-0046           | 29.2       | 15.3 | 2.0            | 14 |

① The E dimension is the minimum nominal opening. These fittings may have a larger opening at the pipe/straight thread end.

### Metric Thread (RS)

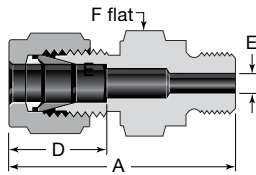

| Tube OD               | Basic Ordering Number | Dimensions |      |                |    |
|-----------------------|-----------------------|------------|------|----------------|----|
|                       |                       | A          | D    | E <sup>①</sup> | F  |
| <b>Dimensions, mm</b> |                       |            |      |                |    |
| 6                     | -6M0-1-M10X1.0RS      | 36.3       | 15.3 | 3.2            | 14 |
|                       | -6M0-1-M12X1.0RS      | 40.4       |      | 4.8            |    |
| 12                    | -12M0-1-M16X1.5RS     | 45.5       | 22.8 | 9.5            | 22 |

① The E dimension is the minimum nominal opening. These fittings may have a larger opening at the pipe/straight thread end.

### Weld Connectors

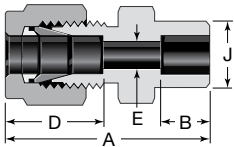

### Tube Socket Weld

| Tube OD                | Socket Weld Size | Basic Ordering Number | Dimensions |      |      |      |      |
|------------------------|------------------|-----------------------|------------|------|------|------|------|
|                        |                  |                       | A          | B    | D    | E    | J    |
| <b>Dimensions, in.</b> |                  |                       |            |      |      |      |      |
| 1/8                    | 1/8              | -200-6-2W             | 1.14       | 0.10 | 0.50 | 0.09 | 0.29 |
| 1/4                    | 1/4              | -400-6-4W             | 1.32       | 0.28 | 0.60 | 0.19 | 0.48 |
| 3/8                    | 3/8              | -600-6-6W             | 1.48       | 0.31 | 0.66 | 0.28 | 0.60 |
| 1/2                    | 1/2              | -810-6-8W             | 1.62       | 0.38 | 0.90 | 0.41 | 0.73 |
| 3/4                    | 3/4              | -1210-6-12W           | 1.71       | 0.44 | 0.96 | 0.62 | 1.04 |
| 1                      | 1                | -1610-6-16W           | 2.07       | 0.62 | 1.23 | 0.88 | 1.36 |

## Straight Fittings

### Weld Connectors

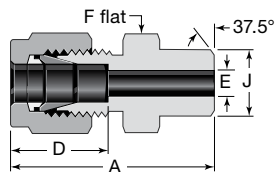

### Male Pipe Weld (Fractional)

| Tube OD                | Pipe Weld Size | Basic Ordering Number | Dimensions |      |                |        |       |
|------------------------|----------------|-----------------------|------------|------|----------------|--------|-------|
|                        |                |                       | A          | D    | E <sup>①</sup> | F      | J     |
| <b>Dimensions, in.</b> |                |                       |            |      |                |        |       |
| 1/8                    | 1/8            | -200-1-2W             | 1.20       | 0.50 | 0.09           | 7/16   | 0.405 |
| 3/16                   | 1/8            | -300-1-2W             | 1.23       | 0.54 | 0.12           | 7/16   | 0.405 |
| 1/4                    | 1/8            | -400-1-2W             | 1.29       | 0.60 | 0.19           | 1/2    | 0.405 |
|                        | 1/4            | -400-1-4W             | 1.49       |      |                | 9/16   | 0.540 |
| 5/16                   | 1/8            | -500-1-2W             | 1.34       | 0.64 | 0.21           | 9/16   | 0.405 |
|                        | 1/4            | -500-1-4W             | 1.52       |      |                |        | 0.540 |
| 3/8                    | 1/4            | -600-1-4W             | 1.57       | 0.66 | 0.28           | 5/8    | 0.540 |
|                        | 3/8            | -600-1-6W             | 1.57       |      |                | 11/16  | 0.675 |
|                        | 1/2            | -600-1-8W             | 1.82       |      |                | 7/8    | 0.840 |
|                        | 3/4            | -600-1-12W            | 1.88       |      |                | 1 1/6  | 1.050 |
| 1/2                    | 3/8            | -810-1-6W             | 1.71       | 0.90 | 0.41           | 13/16  | 0.675 |
|                        | 1/2            | -810-1-8W             | 1.93       |      |                | 7/8    | 0.840 |
|                        | 3/4            | -810-1-12W            | 1.99       |      |                | 1 1/16 | 1.050 |
|                        | 1              | -810-1-16W            | 2.25       |      |                | 1 3/8  | 1.315 |
| 5/8                    | 1/2            | -1010-1-8W            | 1.93       | 0.96 | 0.50           | 15/16  | 0.840 |
| 3/4                    | 1/2            | -1210-1-8W            | 1.99       | 0.96 | 0.55           | 1 1/16 | 0.840 |
|                        | 3/4            | -1210-1-12W           |            |      | 0.62           |        |       |
| 1                      | 1              | -1610-1-16W           | 2.45       | 1.23 | 0.88           | 1 3/8  | 1.315 |
| 1 1/4                  | 1 1/4          | -2000-1-20W           | 3.04       | 1.62 | 1.09           | 1 3/4  | 1.660 |
| 1 1/2                  | 1 1/2          | -2400-1-24W           | 3.50       | 1.97 | 1.34           | 2 1/8  | 1.900 |
| 2                      | 2              | -3200-1-32W           | 4.47       | 2.66 | 1.81           | 2 3/4  | 2.375 |

① The E dimension is the minimum nominal opening. These fittings may have a larger opening at the weld end. Wall thickness at the weld end is based on schedule 80 pipe.

### Male Pipe Weld (Metric to Fractional)

| Tube OD               | Pipe Weld Size in. | Basic Ordering Number | Dimensions |      |                |    |                     |      |
|-----------------------|--------------------|-----------------------|------------|------|----------------|----|---------------------|------|
|                       |                    |                       | A          | D    | E <sup>①</sup> | F  | F, in. <sup>②</sup> | J    |
| <b>Dimensions, mm</b> |                    |                       |            |      |                |    |                     |      |
| 3                     | 1/8                | -3M0-1-2W             | 30.5       | 12.9 | 2.4            | 12 | 1/2                 | 10.3 |
| 4                     | 1/8                | -4M0-1-2W             | 31.2       | 13.7 | 2.4            | 12 | 1/2                 | 10.3 |
| 6                     | 1/8                | -6M0-1-2W             | 32.8       | 15.3 | 4.8            | 14 | 1/2                 | 10.3 |
|                       | 1/4                | -6M0-1-4W             | 37.9       |      |                |    | 9/16                | 13.7 |
| 8                     | 1/8                | -8M0-1-2W             | 34.2       | 16.2 | 5.4            | 15 | 9/16                | 10.3 |
|                       | 1/4                | -8M0-1-4W             | 38.7       |      | 6.4            | 15 | 9/16                | 13.7 |
|                       | 1/2                | -8M0-1-8W             | 45.6       |      | 6.4            | 22 | 7/8                 | 21.3 |
| 10                    | 1/4                | -10M0-1-4W            | 40.9       | 17.2 | 7.5            | 18 | 11/16               | 13.7 |
|                       | 3/8                | -10M0-1-6W            | 40.9       |      | 7.9            | 18 | 11/16               | 17.1 |
|                       | 1/2                | -10M0-1-8W            | 46.5       |      | 7.9            | 22 | 7/8                 | 21.3 |
| 12                    | 1/4                | -12M0-1-4W            | 43.4       | 22.8 | 7.5            | 22 | 13/16               | 13.7 |
|                       | 3/8                | -12M0-1-6W            | 43.4       |      | 9.5            | 22 | 13/16               | 17.1 |
|                       | 1/2                | -12M0-1-8W            | 49.0       |      | 9.5            | 22 | 7/8                 | 21.3 |
|                       | 3/4                | -12M0-1-12W           | 50.5       |      | 9.5            | 27 | 1 1/16              | 26.7 |
| 14                    | 3/8                | -14M0-1-6W            | 44.1       | 24.4 | 10.7           | 24 | 15/16               | 17.1 |
| 15                    | 1/2                | -15M0-1-8W            | 49.0       | 24.4 | 11.9           | 24 | 15/16               | 21.3 |
| 16                    | 1/2                | -16M0-1-8W            | 49.0       | 24.4 | 12.7           | 24 | 15/16               | 21.3 |
| 18                    | 1/2                | -18M0-1-8W            | 50.5       | 24.4 | 13.9           | 27 | 1 1/16              | 21.3 |
| 30                    | 1 1/4              | -30M0-1-20W           | 77.2       | 39.6 | 26.2           | 46 | 46 mm               | 42.2 |
| 32                    | 1 1/4              | -32M0-1-20W           | 79.6       | 42.0 | 28.6           | 46 | 46 mm               | 42.2 |
| 38                    | 1 1/2              | -38M0-1-24W           | 91.6       | 49.4 | 33.7           | 55 | 55 mm               | 48.3 |

① The E dimension is the minimum nominal opening. These fittings may have a larger opening at the weld end. Wall thickness at the weld end is based on schedule 80 pipe.

② This dimension is for steel and aluminum fittings.

## Straight Fittings

### Female Connectors

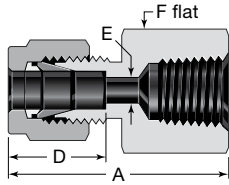

#### NPT

| Tube OD         | NPT Size | Basic Ordering Number | Dimensions |      |      |        |
|-----------------|----------|-----------------------|------------|------|------|--------|
|                 |          |                       | A          | D    | E    | F      |
| Dimensions, in. |          |                       |            |      |      |        |
| 1/16            | 1/16     | -100-7-1              | 0.93       | 0.34 | 0.05 | 7/16   |
|                 | 1/8      | -100-7-2              | 0.96       |      |      | 9/16   |
| 1/8             | 1/8      | -200-7-2              | 1.13       | 0.50 | 0.09 | 9/16   |
|                 | 1/4      | -200-7-4              | 1.32       |      |      | 3/4    |
| 3/16            | 1/8      | -300-7-2              | 1.17       | 0.54 | 0.12 | 9/16   |
| 1/4             | 1/8      | -400-7-2              | 1.23       | 0.60 | 0.19 | 9/16   |
|                 | 1/4      | -400-7-4              | 1.41       |      |      | 3/4    |
|                 | 3/8      | -400-7-6              | 1.48       |      |      | 7/8    |
|                 | 1/2      | -400-7-8              | 1.67       |      |      | 1 1/16 |
| 5/16            | 1/8      | -500-7-2              | 1.26       | 0.64 | 0.25 | 9/16   |
|                 | 1/4      | -500-7-4              | 1.45       |      |      | 3/4    |
| 3/8             | 1/8      | -600-7-2              | 1.29       | 0.66 | 0.28 | 5/8    |
|                 | 1/4      | -600-7-4              | 1.48       |      |      | 3/4    |
|                 | 3/8      | -600-7-6              | 1.54       |      |      | 7/8    |
|                 | 1/2      | -600-7-8              | 1.73       |      |      | 1 1/16 |
|                 | 3/4      | -600-7-12             | 1.88       |      |      | 1 5/16 |
| 1/2             | 1/4      | -810-7-4              | 1.59       | 0.90 | 0.41 | 13/16  |
|                 | 3/8      | -810-7-6              | 1.65       |      |      | 7/8    |
|                 | 1/2      | -810-7-8              | 1.84       |      |      | 1 1/16 |
|                 | 3/4      | -810-7-12             | 1.90       |      |      | 1 5/16 |
| 5/8             | 3/8      | -1010-7-6             | 1.65       | 0.96 | 0.50 | 15/16  |
|                 | 1/2      | -1010-7-8             | 1.84       |      |      | 1 1/16 |
|                 | 3/4      | -1010-7-12            | 1.90       |      |      | 1 5/16 |
| 3/4             | 1/2      | -1210-7-8             | 1.84       | 0.96 | 0.62 | 1 1/16 |
|                 | 3/4      | -1210-7-12            | 1.90       |      |      | 1 5/16 |
| 7/8             | 3/4      | -1410-7-12            | 1.96       | 1.02 | 0.72 | 1 5/16 |
| 1               | 3/4      | -1610-7-12            | 2.10       | 1.23 | 0.88 | 1 3/8  |
|                 | 1        | -1610-7-16            | 2.45       |      |      | 1 5/8  |
| 1 1/4           | 1 1/4    | -2000-7-20            | 2.94       | 1.62 | 1.09 | 2 1/8  |
| 1 1/2           | 1 1/2    | -2400-7-24            | 3.28       | 1.97 | 1.34 | 2 3/8  |
| 2               | 2        | -3200-7-32            | 4.00       | 2.66 | 1.81 | 2 7/8  |

| Tube OD        | NPT Size in. | Basic Ordering Number | Dimensions |      |      |    |
|----------------|--------------|-----------------------|------------|------|------|----|
|                |              |                       | A          | D    | E    | F  |
| Dimensions, mm |              |                       |            |      |      |    |
| 3              | 1/8          | -3M0-7-2              | 28.7       | 12.9 | 2.4  | 14 |
|                | 1/4          | -3M0-7-4              | 33.5       |      |      | 19 |
| 4              | 1/8          | -4M0-7-2              | 29.7       | 13.7 | 2.4  | 14 |
| 6              | 1/8          | -6M0-7-2              | 31.3       | 15.3 | 4.8  | 14 |
|                | 1/4          | -6M0-7-4              | 35.8       |      |      | 19 |
|                | 3/8          | -6M0-7-6              | 37.6       |      |      | 22 |
|                | 1/2          | -6M0-7-8              | 42.5       |      |      | 27 |
| 8              | 1/8          | -8M0-7-2              | 32.1       | 16.2 | 6.4  | 15 |
|                | 1/4          | -8M0-7-4              | 37.0       |      |      | 19 |
|                | 3/8          | -8M0-7-6              | 38.5       |      |      | 22 |
|                | 1/2          | -8M0-7-8              | 43.3       |      |      | 27 |
| 10             | 1/4          | -10M0-7-4             | 37.8       | 17.2 | 7.9  | 19 |
|                | 3/8          | -10M0-7-6             | 39.4       |      |      | 22 |
|                | 1/2          | -10M0-7-8             | 44.2       |      |      | 27 |
| 12             | 1/4          | -12M0-7-4             | 40.3       | 22.8 | 9.5  | 22 |
|                | 3/8          | -12M0-7-6             | 41.9       |      |      | 22 |
|                | 1/2          | -12M0-7-8             | 46.7       |      |      | 27 |
| 15             | 1/2          | -15M0-7-8             | 46.7       | 24.4 | 11.9 | 27 |
| 16             | 1/2          | -16M0-7-8             | 46.9       | 24.4 | 12.7 | 27 |
|                |              |                       |            |      |      |    |
| 20             | 1/2          | -20M0-7-8             | 47.9       | 26.0 | 15.9 | 30 |
|                | 3/4          | -20M0-7-12            | 49.7       |      |      | 35 |
| 22             | 3/4          | -22M0-7-12            | 49.7       | 26.0 | 18.3 | 35 |
|                | 1            | -22M0-7-16            | 57.9       |      |      | 41 |
| 25             | 3/4          | -25M0-7-12            | 53.4       | 31.3 | 21.8 | 35 |
|                | 1            | -25M0-7-16            | 62.3       |      |      | 41 |

## Straight Fittings

### Female Connectors

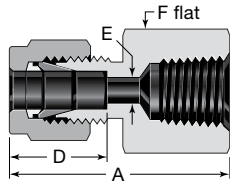

See page 8 for thread specifications.

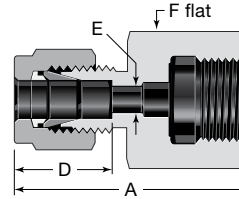

ISO/BSP parallel thread (RJ) fittings are available in stainless steel only.  
See page 8 for thread specifications.

#### ISO/BSP Tapered Thread (RT)

| Tube OD                | ISO Thread Size in. | Basic Ordering Number | Dimensions |      |      |        |
|------------------------|---------------------|-----------------------|------------|------|------|--------|
|                        |                     |                       | A          | D    | E    | F      |
| <b>Dimensions, in.</b> |                     |                       |            |      |      |        |
| 1/8                    | 1/8                 | -200-7-2RT            | 1.13       | 0.50 | 0.09 | 9/16   |
| 1/4                    | 1/8                 | -400-7-2RT            | 1.23       | 0.60 | 0.19 | 9/16   |
|                        | 1/4                 | -400-7-4RT            | 1.41       |      |      | 3/4    |
|                        | 3/8                 | -400-7-6RT            | 1.48       |      |      | 7/8    |
|                        | 1/2                 | -400-7-8RT            | 1.67       |      |      | 1 1/16 |
| 3/8                    | 1/4                 | -600-7-4RT            | 1.48       | 0.66 | 0.28 | 3/4    |
|                        | 3/8                 | -600-7-6RT            | 1.54       |      |      | 7/8    |
|                        | 1/2                 | -600-7-8RT            | 1.73       |      |      | 1 1/16 |
| 1/2                    | 1/4                 | -810-7-4RT            | 1.59       | 0.90 | 0.41 | 13/16  |
|                        | 3/8                 | -810-7-6RT            | 1.65       |      |      | 7/8    |
|                        | 1/2                 | -810-7-8RT            | 1.84       |      |      | 1 1/16 |
| <b>Dimensions, mm</b>  |                     |                       |            |      |      |        |
| 3                      | 1/8                 | -3M0-7-2RT            | 28.7       | 12.9 | 2.4  | 14     |
| 6                      | 1/8                 | -6M0-7-2RT            | 31.3       | 15.3 | 4.8  | 14     |
|                        | 1/4                 | -6M0-7-4RT            | 35.8       |      |      | 19     |
|                        | 3/8                 | -6M0-7-6RT            | 37.6       |      |      | 22     |
|                        | 1/2                 | -6M0-7-8RT            | 42.5       |      |      | 27     |
| 8                      | 1/8                 | -8M0-7-2RT            | 32.1       | 16.2 | 6.4  | 15     |
|                        | 1/4                 | -8M0-7-4RT            | 37.0       |      |      | 19     |
|                        | 3/8                 | -8M0-7-6RT            | 38.5       |      |      | 22     |
|                        | 1/2                 | -8M0-7-8RT            | 43.3       |      |      | 27     |
| 10                     | 1/8                 | -10M0-7-2RT           | 33.0       | 17.2 | 7.9  | 18     |
|                        | 1/4                 | -10M0-7-4RT           | 37.8       |      |      | 19     |
|                        | 3/8                 | -10M0-7-6RT           | 39.4       |      |      | 22     |
|                        | 1/2                 | -10M0-7-8RT           | 44.2       |      |      | 27     |
| 12                     | 1/8                 | -12M0-7-2RT           | 35.5       | 22.8 | 8.3  | 22     |
|                        | 1/4                 | -12M0-7-4RT           | 40.3       |      |      | 22     |
|                        | 3/8                 | -12M0-7-6RT           | 41.9       |      |      | 22     |
|                        | 1/2                 | -12M0-7-8RT           | 46.7       |      |      | 27     |
|                        | 3/4                 | -12M0-7-12RT          | 49.0       |      |      | 35     |
| 15                     | 3/8                 | -15M0-7-6RT           | 41.9       | 24.4 | 11.9 | 24     |
|                        | 1/2                 | -15M0-7-8RT           | 46.7       |      |      | 27     |
| 20                     | 1/2                 | -20M0-7-8RT           | 47.9       | 26.0 | 15.9 | 30     |
|                        | 3/4                 | -20M0-7-12RT          | 49.7       |      |      | 35     |
| 22                     | 3/4                 | -22M0-7-12RT          | 49.7       | 26.0 | 18.3 | 35     |
|                        | 1                   | -22M0-7-16RT          | 57.9       |      |      | 41     |
| 25                     | 3/4                 | -25M0-7-12RT          | 53.4       | 31.3 | 21.8 | 35     |
|                        | 1                   | -25M0-7-16RT          | 62.3       |      |      | 41     |

#### ISO/BSP Parallel Thread (RJ)

| Tube OD                | ISO Thread Size in. | Ordering Number | Dimensions |      |      |        |
|------------------------|---------------------|-----------------|------------|------|------|--------|
|                        |                     |                 | A          | D    | E    | F      |
| <b>Dimensions, in.</b> |                     |                 |            |      |      |        |
| 1/4                    | 1/4                 | SS-400-7-4RJ    | 1.48       | 0.60 | 0.18 | 3/4    |
|                        | 3/8                 | SS-400-7-6RJ    | 1.48       |      | 0.19 | 15/16  |
|                        | 1/2                 | SS-400-7-8RJ    | 1.71       |      | 0.19 | 1 1/16 |
| 5/16                   | 1/4                 | SS-500-7-4RJ    | 1.51       | 0.64 | 0.22 | 3/4    |
|                        | 1/2                 | SS-500-7-8RJ    | 1.61       |      | 0.28 | 1 1/16 |
| 3/8                    | 1/4                 | SS-600-7-4RJ    | 1.54       | 0.66 | 0.22 | 3/4    |
|                        | 3/8                 | SS-600-7-6RJ    | 1.52       |      | 0.26 | 15/16  |
|                        | 1/2                 | SS-600-7-8RJ    | 1.65       |      | 0.28 | 1 1/16 |
| 1/2                    | 1/4                 | SS-810-7-4RJ    | 1.65       | 0.90 | 0.22 | 13/16  |
|                        | 3/8                 | SS-810-7-6RJ    | 1.75       |      | 0.26 | 15/16  |
|                        | 1/2                 | SS-810-7-8RJ    | 1.90       |      | 0.28 | 1 1/16 |
| <b>Dimensions, mm</b>  |                     |                 |            |      |      |        |
| 6                      | 1/4                 | SS-6M0-7-4RJ    | 37.6       | 15.3 | 4.8  | 19     |
|                        | 3/8                 | SS-6M0-7-6RJ    | 37.6       |      |      | 24     |
|                        | 1/2                 | SS-6M0-7-8RJ    | 43.5       |      |      | 27     |
| 8                      | 1/4                 | SS-8M0-7-4RJ    | 38.5       | 16.2 | 5.5  | 19     |
|                        | 3/8                 | SS-8M0-7-6RJ    | 36.2       |      | 6.5  | 24     |
|                        | 1/2                 | SS-8M0-7-8RJ    | 41.0       |      | 7.0  | 27     |
| 10                     | 1/4                 | SS-10M0-7-4RJ   | 39.4       | 17.2 | 5.5  | 19     |
|                        | 3/8                 | SS-10M0-7-6RJ   | 38.8       |      | 6.5  | 24     |
|                        | 1/2                 | SS-10M0-7-8RJ   | 42.1       |      | 7.0  | 27     |
| 12                     | 1/4                 | SS-12M0-7-4RJ   | 41.9       | 22.8 | 5.5  | 22     |
|                        | 3/8                 | SS-12M0-7-6RJ   | 44.4       |      | 6.5  | 24     |
|                        | 1/2                 | SS-12M0-7-8RJ   | 48.2       |      | 7.0  | 27     |

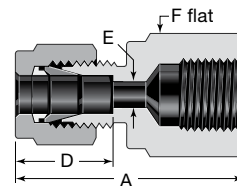

See page 8 for thread specifications.

#### ISO/BSP Parallel Thread (RP)

| Tube OD               | ISO Thread Size in. | Basic Ordering Number | Dimensions |      |      |    |
|-----------------------|---------------------|-----------------------|------------|------|------|----|
|                       |                     |                       | A          | D    | E    | F  |
| <b>Dimensions, mm</b> |                     |                       |            |      |      |    |
| 6                     | 1/8                 | -6M0-7-2RP            | 33.5       | 15.3 | 4.8  | 14 |
|                       | 1/4                 | -6M0-7-4RP            | 39.4       |      |      | 19 |
| 22                    | 3/4                 | -22M0-7-12RP          | 53.3       | 26.0 | 18.3 | 35 |
| 25                    | 1                   | -25M0-7-16RP          | 63.9       | 26.5 | 21.8 | 40 |

## Straight Fittings

### Female Connectors

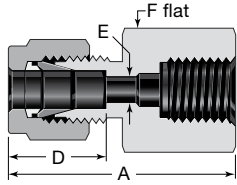

See page 8 for thread specifications.  
ISO/BSP parallel gaskets are available.  
See page 53.

### ISO/BSP Parallel Thread (RG, Gauge)

| Tube OD                | ISO Thread Size in. | Basic Ordering Number | Dimensions |      |      |        |
|------------------------|---------------------|-----------------------|------------|------|------|--------|
|                        |                     |                       | A          | D    | E    | F      |
| <b>Dimensions, in.</b> |                     |                       |            |      |      |        |
| 1/8                    | 1/4                 | -200-7-4RG            | 1.39       | 0.59 | 0.09 | 3/4    |
| 1/4                    | 1/8                 | -400-7-2RG            | 1.26       | 0.60 | 0.18 | 9/16   |
|                        | 1/4                 | -400-7-4RG            | 1.48       |      | 0.19 | 3/4    |
|                        | 3/8                 | -400-7-6RG            | 1.48       |      | 0.19 | 15/16  |
|                        | 1/2                 | -400-7-8RG            | 1.71       |      | 0.19 | 1 1/16 |
| 5/16                   | 1/4                 | -500-7-4RG            | 1.51       | 0.64 | 0.22 | 3/4    |
|                        | 1/2                 | -500-7-8RG            | 1.61       |      | 0.28 | 1 1/16 |
| 3/8                    | 1/4                 | -600-7-4RG            | 1.54       | 0.66 | 0.22 | 3/4    |
|                        | 3/8                 | -600-7-6RG            | 1.52       |      | 0.26 | 15/16  |
|                        | 1/2                 | -600-7-8RG            | 1.65       |      | 0.28 | 1 1/16 |
| 1/2                    | 3/8                 | -810-7-6RG            | 1.75       | 0.90 | 0.26 | 15/16  |
|                        | 1/2                 | -810-7-8RG            | 1.90       |      | 0.28 | 1 1/16 |
| <b>Dimensions, mm</b>  |                     |                       |            |      |      |        |
| 3                      | 1/4                 | -3M0-7-4RG            | 35.3       | 12.9 | 2.4  | 19     |
| 6                      | 1/8                 | -6M0-7-2RG            | 32.0       | 15.3 | 4.5  | 14     |
|                        | 1/4                 | -6M0-7-4RG            | 37.6       |      | 4.8  | 19     |
|                        | 3/8                 | -6M0-7-6RG            | 37.6       |      | 4.8  | 24     |
|                        | 1/2                 | -6M0-7-8RG            | 43.5       |      | 4.8  | 27     |
| 8                      | 1/4                 | -8M0-7-4RG            | 38.5       | 16.2 | 5.5  | 19     |
|                        | 3/8                 | -8M0-7-6RG            | 36.2       |      | 6.5  | 24     |
|                        | 1/2                 | -8M0-7-8RG            | 41.0       |      | 7.0  | 27     |
| 10                     | 1/4                 | -10M0-7-4RG           | 39.4       | 17.2 | 5.5  | 19     |
|                        | 3/8                 | -10M0-7-6RG           | 38.8       |      | 6.5  | 24     |
|                        | 1/2                 | -10M0-7-8RG           | 42.1       |      | 7.0  | 27     |
| 12                     | 1/4                 | -12M0-7-4RG           | 41.9       | 22.8 | 5.5  | 22     |
|                        | 3/8                 | -12M0-7-6RG           | 44.4       |      | 6.5  | 24     |
|                        | 1/2                 | -12M0-7-8RG           | 48.2       |      | 7.0  | 27     |
| 20                     | 1/2                 | -20M0-7-8RG           | 54.3       | 26.0 | 7.0  | 30     |
| 22                     | 1/2                 | -22M0-7-8RG           | 54.3       | 26.0 | 7.0  | 30     |

### Bulkhead NPT

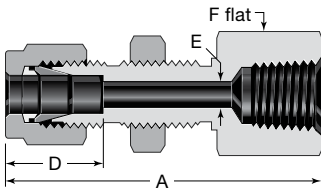

| Tube OD                | NPT Size in. | Basic Ordering Number | Dimensions |      |      |        |                 |                     |
|------------------------|--------------|-----------------------|------------|------|------|--------|-----------------|---------------------|
|                        |              |                       | A          | D    | E    | F      | Panel Hole Size | Max Panel Thickness |
| <b>Dimensions, in.</b> |              |                       |            |      |      |        |                 |                     |
| 1/8                    | 1/8          | -200-71-2             | 1.76       | 0.50 | 0.09 | 9/16   | 21/64           | 0.50                |
| 1/4                    | 1/8          | -400-71-2             | 1.85       | 0.60 | 0.19 | 5/8    | 29/64           | 0.40                |
|                        | 1/4          | -400-71-4             | 2.04       |      |      | 3/4    |                 |                     |
| 3/8                    | 1/4          | -600-71-4             | 2.17       | 0.66 | 0.28 | 3/4    | 37/64           | 0.44                |
| 1/2                    | 3/8          | -810-71-6             | 2.43       | 0.90 | 0.41 | 15/16  | 49/64           | 0.50                |
|                        | 1/2          | -810-71-8             | 2.62       |      |      | 1 1/16 |                 |                     |
| <b>Dimensions, mm</b>  |              |                       |            |      |      |        |                 |                     |
| 6                      | 1/4          | -6M0-71-4             | 51.8       | 15.3 | 4.8  | 19     | 11.5            | 10.2                |
| 12                     | 1/2          | -12M0-71-8            | 66.5       | 22.8 | 9.5  | 27     | 19.5            | 12.7                |



## Straight Fittings

### Reducers

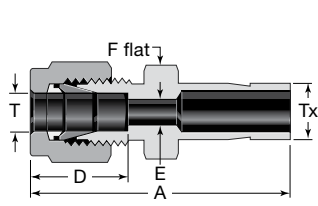

1 in. and Under

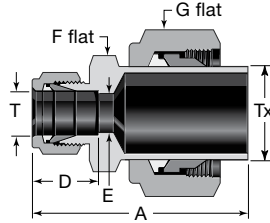

Over 1 in.

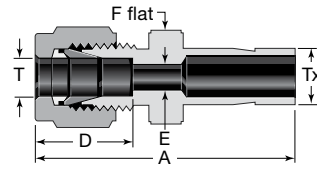

25 mm and Under

### Reducer (Fractional)

| Tube OD         |  | Basic Ordering Number  | Dimensions   |   |  |   |  |   |  |   |              |                          |              |
|-----------------|--|--|--|---|--|---|--|---|--|---|--------------|--------------------------|--------------|
| T               | Tx                                       |  | A  | D   | E  | F   | G  |   |  |   |              |                          |              |
| Dimensions, in. |  |  |  |   |  |   |  |   |  |   |              |                          |              |
| 1/16            | 1/8<br>1/4                               | -100-R-2<br>-100-R-4   | 1.15<br>1.24   | 0.34  | 0.05   | 5/16  | —  |   |  |   |              |                          |              |
| 1/8             | 1/16<br>1/8<br>3/16<br>1/4<br>3/8<br>1/2 | -200-R-1<br>-200-R-2<br>-200-R-3<br>-200-R-4<br>-200-R-6<br>-200-R-8 | 1.14<br>1.32<br>1.35<br>1.42<br>1.48<br>1.74   | 0.50  | 0.03<br>0.08<br>0.09<br>0.09<br>0.09<br>0.09                 | 7/16<br>7/16<br>7/16<br>7/16<br>7/16<br>9/16                                  | —  |   |  |   |              |                          |              |
|                 | 3/16                                     | 1/8<br>1/4   | -300-R-2<br>-300-R-4   |   | 1.37<br>1.46   | 0.54  | 0.08<br>0.12   | 7/16<br>—   |  |   |              |                          |              |
|                 | 1/4                                      | 1/8<br>3/16<br>1/4<br>5/16<br>3/8<br>1/2<br>5/8<br>3/4               | -400-R-2<br>-400-R-3<br>-400-R-4<br>-400-R-5<br>-400-R-6<br>-400-R-8<br>-400-R-10<br>-400-R-12 |   | 1.45<br>1.48<br>1.54<br>1.57<br>1.60<br>1.82<br>1.89<br>1.88 | 0.60  | 0.08<br>0.12<br>0.17<br>0.19<br>0.19<br>0.19<br>0.19<br>0.19 | 1/2<br>1/2<br>1/2<br>1/2<br>1/2<br>9/16<br>11/16<br>13/16 | —  |   |              |                          |              |
|                 |  | 5/16   | 3/8<br>1/2   |   | -500-R-6<br>-500-R-8   |   | 1.65<br>1.87   | 0.64  | 0.25   | 9/16<br>—   |              |                          |              |
|                 |  | 3/8  | 1/4<br>3/8<br>1/2<br>5/8<br>3/4  |   | -600-R-4<br>-600-R-6<br>-600-R-8<br>-600-R-10<br>-600-R-12   |   | 1.63<br>1.70<br>1.91<br>1.98<br>1.98                         | 0.66  | 0.17<br>0.27<br>0.28<br>0.28<br>0.28         | 5/8<br>5/8<br>5/8<br>11/16<br>13/16                 | —            |                          |              |
| 1/2             |  |  | 1/4<br>3/8<br>1/2<br>5/8<br>3/4<br>1   | -810-R-4<br>-810-R-6<br>-810-R-8<br>-810-R-10<br>-810-R-12<br>-810-R-16 | 1.77<br>1.84<br>2.06<br>2.12<br>2.12<br>2.37                 |   | 0.90   |   | 0.17<br>0.27<br>0.37<br>0.41<br>0.41<br>0.41 | 13/16<br>13/16<br>13/16<br>13/16<br>13/16<br>1 1/16 | —            |                          |              |
|                 |  |  | 5/8  | 3/4<br>7/8<br>1   | -1010-R-12<br>-1010-R-14<br>-1010-R-16                       |   |  |   | 2.15<br>2.21<br>2.40                         | 0.96  | 0.50         | 15/16<br>15/16<br>1 1/16 | —            |
|                 |  |  |  | 3/4   | 1/2<br>1   |   |  |   | -1210-R-8<br>-1210-R-16                      |   | 2.15<br>2.46 | 0.96                     | 0.37<br>0.62 |
|                 | 1  |  |  |   | 1 1/4<br>1 1/2<br>2  | -1610-R-20 <sup>①</sup><br>-1610-R-24 <sup>①</sup><br>-1610-R-32 <sup>①</sup> |  |   | 3.17<br>3.51<br>4.43                         |   | 1.23         |                          | 0.88         |
|                 |  | 1 1/4  | 1 1/2<br>2   | -2000-R-24 <sup>①</sup><br>-2000-R-32 <sup>①</sup>                      | 4.10<br>4.93   | 1.62  |  | 1.09  | 1 3/4<br>2 1/8                               | 2 1/4<br>3  |              |                          |              |
| 1 1/2           |  |  | 2  | -2400-R-32 <sup>①</sup>   | 5.17   |   | 1.97   | 1.34  | 2 1/8  | 3   |              |                          |              |

① Furnished with nut and preswaged ferrules.

### Reducer (Metric)

| Tube OD        |          | Basic Ordering Number    | Dimensions   |      |            |          |
|----------------|----------|--------------------------|--------------|------|------------|----------|
| T              | Tx       |                          | A            | D    | E          | F        |
| Dimensions, mm |          |                          |              |      |            |          |
| 2              | 3        | -2M0-R-3M                | 33.5         | 12.9 | 1.7        | 12       |
| 3              | 4        | -3M0-R-4M                | 35.0         | 12.9 | 2.4        | 12       |
|                | 6<br>10  | -3M0-R-6M<br>-3M0-R-10M  | 36.1<br>38.4 |      |            |          |
| 4              | 6        | -4M0-R-6M                | 37.1         | 13.7 | 2.4        | 12       |
| 6              | 3        | -6M0-R-3M                | 36.9         | 15.3 | 1.9        | 14       |
|                | 8        | -6M0-R-8M                | 39.9         |      | 4.8        | 14       |
|                | 10       | -6M0-R-10M               | 40.7         |      | 4.8        | 14       |
|                | 12<br>18 | -6M0-R-12M<br>-6M0-R-18M | 46.3<br>49.6 |      | 4.8<br>4.8 | 14<br>22 |
| 8              | 6        | -8M0-R-6M                | 40.3         | 16.2 | 4.1        | 15       |
|                | 10       | -8M0-R-10M               | 42.0         |      | 6.4        |          |
|                | 12       | -8M0-R-12M               | 47.6         |      | 6.4        |          |
| 10             | 6        | -10M0-R-6M               | 42.4         | 17.2 | 4.1        | 18       |
|                | 8        | -10M0-R-8M               | 43.4         |      | 5.6        | 18       |
|                | 12       | -10M0-R-12M              | 49.8         |      | 7.9        | 18       |
|                | 15       | -10M0-R-15M              | 51.3         |      | 7.9        | 18       |
|                | 18       | -10M0-R-18M              | 51.3         |      | 7.9        | 22       |
| 12             | 6        | -12M0-R-6M               | 44.9         | 22.8 | 4.1        | 22       |
|                | 8        | -12M0-R-8M               | 45.9         |      | 5.6        | 22       |
|                | 10       | -12M0-R-10M              | 46.7         |      | 7.1        | 22       |
|                | 16       | -12M0-R-16M              | 53.8         |      | 9.5        | 22       |
|                | 18       | -12M0-R-18M              | 53.8         |      | 9.5        | 22       |
|                | 20       | -12M0-R-20M              | 56.1         |      | 9.5        | 22       |
|                | 22       | -12M0-R-22M              | 56.1         |      | 9.5        | 24       |
|                | 25       | -12M0-R-25M              | 62.4         |      | 9.5        | 27       |
| 16             | 12       | -16M0-R-12M              | 53.0         | 24.4 | 8.8        | 24       |
| 18             | 12       | -18M0-R-12M              | 54.6         | 24.4 | 8.8        | 27       |
|                | 16       | -18M0-R-16M              | 56.1         |      | 12.0       |          |
|                | 20       | -18M0-R-20M              | 57.6         |      | 15.1       |          |
|                | 22       | -18M0-R-22M              | 57.6         |      | 15.1       |          |
|                | 25       | -18M0-R-25M              | 62.4         |      | 15.1       |          |
| 20             | 16       | -20M0-R-16M              | 57.9         | 26.0 | 12.0       | 30       |
|                | 18       | -20M0-R-18M              | 57.9         |      | 13.9       |          |
|                | 22       | -20M0-R-22M              | 59.4         |      | 15.9       |          |
|                | 25       | -20M0-R-25M              | 64.2         |      | 15.9       |          |
| 22             | 18       | -22M0-R-18M              | 57.9         | 26.0 | 13.9       | 30       |
|                | 20       | -22M0-R-20M              | 59.4         |      | 15.5       |          |
|                | 25       | -22M0-R-25M              | 64.2         |      | 18.3       |          |
| 25             | 18       | -25M0-R-18M              | 63.1         | 31.3 | 13.9       | 35       |
|                | 20       | -25M0-R-20M              | 64.6         |      | 15.5       |          |

## Straight Fittings

### Reducers

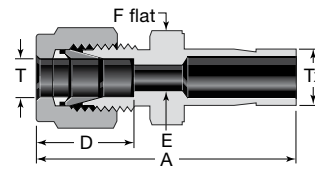
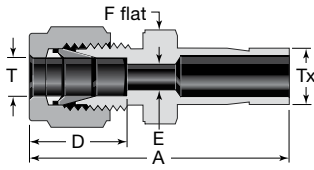

**Reducer (Metric to Fractional)**

| Tube OD               |         | Basic Ordering Number | Dimensions |      |     |    |
|-----------------------|---------|-----------------------|------------|------|-----|----|
| T                     | Tx, in. |                       | A          | D    | E   | F  |
| <b>Dimensions, mm</b> |         |                       |            |      |     |    |
| 2                     | 1/8     | -2M0-R-2              | 33.5       | 12.9 | 1.7 | 12 |
| 3                     | 1/8     | -3M0-R-2              | 33.5       | 12.9 | 2.0 | 12 |
|                       | 1/4     | -3M0-R-4              | 36.1       | 12.9 | 2.4 | 12 |
| 4                     | 1/4     | -4M0-R-4              | 37.1       | 13.7 | 2.4 | 12 |
| 6                     | 1/8     | -6M0-R-2              | 36.9       | 15.3 | 2.0 | 14 |
|                       | 1/4     | -6M0-R-4              | 39.2       |      | 4.4 |    |
|                       | 5/16    | -6M0-R-5              | 39.9       |      | 4.8 |    |
|                       | 3/8     | -6M0-R-6              | 40.7       |      | 4.8 |    |
| 8                     | 1/2     | -6M0-R-8              | 46.3       | 4.8  | 15  |    |
|                       | 1/4     | -8M0-R-4              | 40.3       | 4.4  |     |    |
|                       | 3/8     | -8M0-R-6              | 42.0       | 6.4  |     |    |
| 10                    | 1/2     | -8M0-R-8              | 47.6       | 6.4  | 18  |    |
|                       | 3/8     | -10M0-R-6             | 44.2       | 6.8  |     |    |
| 12                    | 1/2     | -10M0-R-8             | 49.8       | 7.9  | 22  |    |
|                       | 3/4     | -12M0-R-8             | 52.3       | 9.3  |     |    |
| 18                    | 3/4     | -12M0-R-12            | 53.8       | 9.5  | 27  |    |
|                       | 1       | -18M0-R-12            | 56.1       | 14.7 |     |    |
| 25                    | 1       | -18M0-R-16            | 62.4       | 15.1 | 35  |    |
|                       |         | -25M0-R-16            | 69.5       | 20.2 |     |    |

**Reducer (Fractional to Metric)**

| Tube OD                |        | Basic Ordering Number | Dimensions |      |      |      |
|------------------------|--------|-----------------------|------------|------|------|------|
| T                      | Tx, mm |                       | A          | D    | E    | F    |
| <b>Dimensions, in.</b> |        |                       |            |      |      |      |
| 1/8                    | 6      | -200-R-6M             | 1.42       | 0.50 | 0.09 | 7/16 |

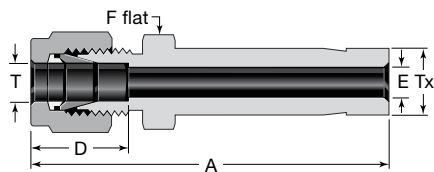

**Long Reducer**

| Tube OD                |     | Basic Ordering Number | Dimensions |      |      |     |
|------------------------|-----|-----------------------|------------|------|------|-----|
| T                      | Tx  |                       | A          | D    | E    | F   |
| <b>Dimensions, in.</b> |     |                       |            |      |      |     |
| 3/8                    | 1/2 | -600-RF-8             | 2.57       | 0.66 | 0.25 | 5/8 |

Use only long reducers in female Swagelok end connections.

**Bulkhead Reducer**

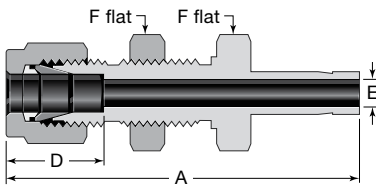

| Tube OD                | Basic Ordering Number | Dimensions |      |      |        |                 |                     |
|------------------------|-----------------------|------------|------|------|--------|-----------------|---------------------|
|                        |                       | A          | D    | E    | F      | Panel Hole Size | Max Panel Thickness |
| <b>Dimensions, in.</b> |                       |            |      |      |        |                 |                     |
| 1/8                    | -200-R1-2             | 1.95       | 0.50 | 0.08 | 1/2    | 21/64           | 0.50                |
| 1/4                    | -400-R1-4             | 2.20       | 0.60 | 0.17 | 5/8    | 29/64           | 0.40                |
| 3/8                    | -600-R1-6             | 2.41       | 0.66 | 0.27 | 3/4    | 37/64           | 0.44                |
| 1/2                    | -810-R1-8             | 2.87       | 0.90 | 0.37 | 15/16  | 49/64           | 0.50                |
| 5/8                    | -1010-R1-10           | 2.96       | 0.96 | 0.47 | 1 1/16 | 57/64           | 0.50                |
| 3/4                    | -1210-R1-12           | 3.21       | 0.96 | 0.58 | 1 3/16 | 1 1/64          | 0.66                |
| 1                      | -1610-R1-16           | 3.95       | 1.23 | 0.80 | 1 5/8  | 1 21/64         | 0.75                |

## Straight Fittings

### Port Connectors

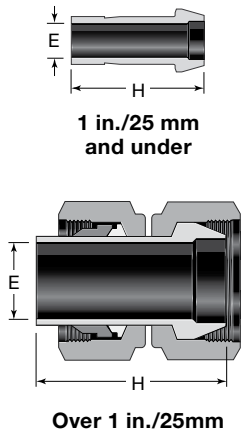

### Port Connector

| Tube OD                | Basic Ordering Number | Dimensions |      |
|------------------------|-----------------------|------------|------|
|                        |                       | E          | H    |
| <b>Dimensions, in.</b> |                       |            |      |
| 1/16                   | -101-PC               | 0.03       | 0.54 |
| 1/8                    | -201-PC               | 0.08       | 0.88 |
| 1/4                    | -401-PC               | 0.17       | 0.98 |
| 5/16                   | -501-PC               | 0.22       | 1.02 |
| 3/8                    | -601-PC               | 0.27       | 1.05 |
| 1/2                    | -811-PC               | 0.37       | 1.43 |
| 5/8                    | -1011-PC              | 0.47       | 1.49 |
| 3/4                    | -1211-PC              | 0.58       | 1.49 |
| 1                      | -1611-PC              | 0.80       | 1.94 |
| 1 1/4                  | -2000-PC <sup>①</sup> | 1.02       | 2.72 |
| 1 1/2                  | -2400-PC <sup>①</sup> | 1.25       | 3.31 |
| 2                      | -3200-PC <sup>①</sup> | 1.72       | 4.56 |

① Furnished with nuts and preswaged ferrules.

| Tube OD               | Basic Ordering Number | Dimensions |      |
|-----------------------|-----------------------|------------|------|
|                       |                       | E          | H    |
| <b>Dimensions, mm</b> |                       |            |      |
| 3                     | -3M1-PC               | 1.9        | 22.2 |
| 6                     | -6M1-PC               | 4.1        | 25.0 |
| 8                     | -8M1-PC               | 5.6        | 26.0 |
| 10                    | -10M1-PC              | 7.1        | 27.1 |
| 12                    | -12M1-PC              | 8.8        | 36.2 |
| 15                    | -15M1-PC              | 11.2       | 37.8 |
| 16                    | -16M1-PC              | 12.0       | 37.8 |
| 18                    | -18M1-PC              | 13.9       | 37.8 |
| 20                    | -20M1-PC              | 15.5       | 39.4 |
| 25                    | -25M1-PC              | 19.9       | 49.3 |
| 28                    | -28M0-PC <sup>①</sup> | 22.5       | 63.5 |
| 30                    | -30M0-PC <sup>①</sup> | 24.3       | 67.6 |
| 32                    | -32M0-PC <sup>①</sup> | 26.5       | 69.7 |
| 38                    | -38M0-PC <sup>①</sup> | 31.6       | 81.9 |

① Furnished with nuts and preswaged ferrules.

### Reducing Port Connector

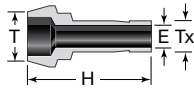

| Tube OD                |      | Basic Ordering Number | Dimensions |      |
|------------------------|------|-----------------------|------------|------|
| T                      | Tx   |                       | E          | H    |
| <b>Dimensions, in.</b> |      |                       |            |      |
| 1/8                    | 1/16 | -201-PC-1             | 0.03       | 0.72 |
| 1/4                    | 1/16 | -401-PC-1             | 0.03       | 0.75 |
|                        | 1/8  | -401-PC-2             | 0.08       | 0.90 |
| 3/8                    | 1/8  | -601-PC-2             | 0.08       | 0.92 |
|                        | 1/4  | -601-PC-4             | 0.17       | 1.00 |
| 1/2                    | 1/4  | -811-PC-4             | 0.17       | 1.17 |
|                        | 3/8  | -811-PC-6             | 0.27       | 1.21 |
| 3/4                    | 1/2  | -1211-PC-8            | 0.37       | 1.49 |
| 1                      | 1/2  | -1611-PC-8            | 0.37       | 1.69 |
|                        | 3/4  | -1611-PC-12           | 0.58       | 1.72 |

| Tube OD               |    | Basic Ordering Number | Dimensions |      |
|-----------------------|----|-----------------------|------------|------|
| T                     | Tx |                       | E          | H    |
| <b>Dimensions, mm</b> |    |                       |            |      |
| 6                     | 3  | -6M1-PC-3M            | 1.9        | 22.9 |
| 8                     | 6  | -8M1-PC-6M            | 4.1        | 25.4 |
| 10                    | 6  | -10M1-PC-6M           | 4.1        | 25.8 |
|                       | 8  | -10M1-PC-8M           | 5.6        | 26.3 |
| 12                    | 6  | -12M1-PC-6M           | 4.1        | 29.6 |
|                       | 8  | -12M1-PC-8M           | 5.6        | 30.1 |
|                       | 10 | -12M1-PC-10M          | 7.1        | 30.6 |
| 16                    | 12 | -16M1-PC-12M          | 8.8        | 37.5 |
| 28                    | 25 | -28M1-PC-25M          | 19.8       | 56.5 |
| 32                    | 25 | -32M1-PC-25M          | 19.8       | 60.3 |
| 38                    | 25 | -38M1-PC-25M          | 19.8       | 65.8 |

## Straight Fittings

### Caps and Plugs

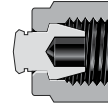
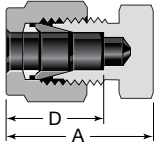

#### Cap

| Tube OD         | Basic Ordering Number | A    | D    |
|-----------------|-----------------------|------|------|
| Dimensions, in. |                       |      |      |
| 1/16            | -100-C                | 0.59 | 0.34 |
| 1/8             | -200-C                | 0.79 | 0.50 |
| 3/16            | -300-C                | 0.84 | 0.54 |
| 1/4             | -400-C                | 0.92 | 0.60 |
| 5/16            | -500-C                | 0.96 | 0.64 |
| 3/8             | -600-C                | 1.01 | 0.66 |
| 1/2             | -810-C                | 1.21 | 0.90 |
| 5/8             | -1010-C               | 1.24 | 0.96 |
| 3/4             | -1210-C               | 1.27 | 0.96 |
| 7/8             | -1410-C               | 1.37 | 1.02 |
| 1               | -1610-C               | 1.61 | 1.23 |
| 1 1/8           | -1810-C               | 1.61 | 1.23 |
| 1 1/4           | -2000-C               | 2.10 | 1.62 |
| 1 1/2           | -2400-C               | 2.54 | 1.97 |
| 2               | -3200-C               | 3.41 | 2.66 |

| Tube OD        | Basic Ordering Number | A    | D    |
|----------------|-----------------------|------|------|
| Dimensions, mm |                       |      |      |
| 2              | -2M0-C                | 20.1 | 12.9 |
| 3              | -3M0-C                | 20.1 | 12.9 |
| 4              | -4M0-C                | 21.3 | 13.7 |
| 6              | -6M0-C                | 23.1 | 15.3 |
| 8              | -8M0-C                | 24.5 | 16.2 |
| 10             | -10M0-C               | 26.6 | 17.2 |
| 12             | -12M0-C               | 30.6 | 22.8 |
| 14             | -14M0-C               | 31.4 | 24.4 |
| 15             | -15M0-C               | 31.4 | 24.4 |
| 16             | -16M0-C               | 31.4 | 24.4 |
| 18             | -18M0-C               | 32.2 | 24.4 |
| 20             | -20M0-C               | 34.8 | 26.0 |
| 22             | -22M0-C               | 34.8 | 26.0 |
| 25             | -25M0-C               | 41.0 | 31.3 |
| 28             | -28M0-C               | 48.5 | 36.6 |
| 30             | -30M0-C               | 53.4 | 39.6 |
| 32             | -32M0-C               | 55.8 | 42.0 |
| 38             | -38M0-C               | 65.4 | 49.4 |

#### Plug

| Tube OD         | Basic Ordering Number |
|-----------------|-----------------------|
| Dimensions, in. |                       |
| 1/16            | -100-P                |
| 1/8             | -200-P                |
| 3/16            | -300-P                |
| 1/4             | -400-P                |
| 5/16            | -500-P                |
| 3/8             | -600-P                |
| 1/2             | -810-P                |
| 5/8             | -1010-P               |
| 3/4             | -1210-P               |
| 7/8             | -1410-P               |
| 1               | -1610-P               |
| 1 1/4           | -2000-P               |
| 1 1/2           | -2400-P               |
| 2               | -3200-P               |

| Tube OD        | Basic Ordering Number |
|----------------|-----------------------|
| Dimensions, mm |                       |
| 2              | -2M0-P                |
| 3              | -3M0-P                |
| 4              | -4M0-P                |
| 6              | -6M0-P                |
| 8              | -8M0-P                |
| 10             | -10M0-P               |
| 12             | -12M0-P               |
| 15             | -15M0-P               |
| 16             | -16M0-P               |
| 18             | -18M0-P               |
| 20             | -20M0-P               |
| 22             | -22M0-P               |
| 25             | -25M0-P               |
| 28             | -28M0-P               |
| 30             | -30M0-P               |
| 32             | -32M0-P               |
| 38             | -38M0-P               |

### Vent Protectors

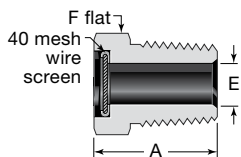

40 mesh 300 series stainless steel wire screen assembly

### Mud Dauber

Swagelok vent protectors, more commonly known as **mud dauber fittings**, protect open ends of instruments, tubing, outlet vents, and bleed-off lines.

The mesh wire screen prevents foreign objects, such as mud dauber insects, from entering and clogging various systems and causing damage.

Vent protectors are available in stainless steel and brass. To order brass, replace **SS** in the ordering number with **B**.

Example: **B**-MD-2

| NPT Size        | Ordering Number | A    | E    | F      |
|-----------------|-----------------|------|------|--------|
| Dimensions, in. |                 |      |      |        |
| 1/8             | SS-MD-2         | 0.56 | 0.19 | 1/2    |
| 1/4             | SS-MD-4         | 0.78 | 0.28 | 9/16   |
| 3/8             | SS-MD-6         | 0.81 | 0.41 | 11/16  |
| 1/2             | SS-MD-8         | 1.03 | 0.50 | 7/8    |
| 3/4             | SS-MD-12        | 1.06 | 0.72 | 1 1/16 |

## 90° Elbows

### Unions

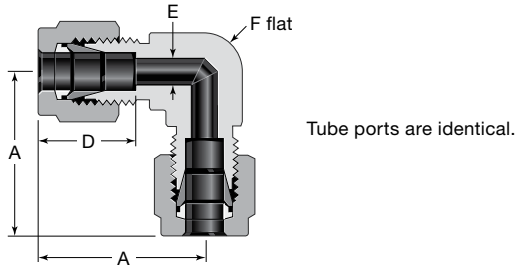

| Tube OD         | Basic Ordering Number | Dimensions |      |      |         |
|-----------------|-----------------------|------------|------|------|---------|
|                 |                       | A          | D    | E    | F       |
| Dimensions, in. |                       |            |      |      |         |
| 1/16            | -100-9                | 0.70       | 0.34 | 0.05 | 3/8     |
| 1/8             | -200-9                | 0.88       | 0.50 | 0.09 | 3/8     |
| 3/16            | -300-9                | 1.00       | 0.54 | 0.12 | 1/2     |
| 1/4             | -400-9                | 1.06       | 0.60 | 0.19 | 1/2     |
| 5/16            | -500-9                | 1.13       | 0.64 | 0.25 | 9/16    |
| 3/8             | -600-9                | 1.20       | 0.66 | 0.28 | 5/8     |
| 1/2             | -810-9                | 1.42       | 0.90 | 0.41 | 13/16   |
| 5/8             | -1010-9               | 1.50       | 0.96 | 0.50 | 15/16   |
| 3/4             | -1210-9               | 1.57       | 0.96 | 0.62 | 1 1/16  |
| 7/8             | -1410-9               | 1.76       | 1.02 | 0.72 | 1 3/8   |
| 1               | -1610-9               | 1.93       | 1.23 | 0.88 | 1 3/8   |
| 1 1/8           | -1810-9               | 2.17       | 1.23 | 0.97 | 1 11/16 |
| 1 1/4           | -2000-9               | 2.67       | 1.62 | 1.09 | 1 11/16 |
| 1 1/2           | -2400-9               | 3.10       | 1.97 | 1.34 | 2       |
| 2               | -3200-9               | 4.22       | 2.66 | 1.81 | 2 3/4   |

| Tube OD        | Basic Ordering Number | Dimensions |      |      |        |
|----------------|-----------------------|------------|------|------|--------|
|                |                       | A          | D    | E    | F, in. |
| Dimensions, mm |                       |            |      |      |        |
| 3              | -3M0-9                | 22.3       | 12.9 | 2.4  | 3/8    |
| 4              | -4M0-9                | 25.4       | 13.7 | 2.4  | 1/2    |
| 6              | -6M0-9                | 27.0       | 15.3 | 4.8  | 1/2    |
| 8              | -8M0-9                | 28.8       | 16.2 | 6.4  | 9/16   |
| 10             | -10M0-9               | 31.5       | 17.2 | 7.9  | 11/16  |
| 12             | -12M0-9               | 36.0       | 22.8 | 9.5  | 13/16  |
| 14             | -14M0-9               | 38.0       | 24.4 | 11.1 | 15/16  |
| 15             | -15M0-9               | 38.0       | 24.4 | 11.9 | 15/16  |
| 16             | -16M0-9               | 38.0       | 24.4 | 12.7 | 15/16  |
| 18             | -18M0-9               | 39.8       | 24.4 | 15.1 | 1 1/16 |
| 20             | -20M0-9               | 44.6       | 26.0 | 15.9 | 1 3/8  |
| 22             | -22M0-9               | 44.6       | 26.0 | 18.3 | 1 3/8  |
| 25             | -25M0-9               | 49.1       | 31.3 | 21.8 | 1 3/8  |
| 28             | -28M0-9               | 64.0       | 36.6 | 21.8 | 41 mm  |
| 30             | -30M0-9               | 69.9       | 39.6 | 26.2 | 46 mm  |
| 32             | -32M0-9               | 72.3       | 42.0 | 28.6 | 46 mm  |
| 38             | -38M0-9               | 84.0       | 49.4 | 33.7 | 55 mm  |
| 50             | -50M0-9               | 106        | 65.0 | 45.2 | 2 3/4  |

## 90° Elbows

### Male

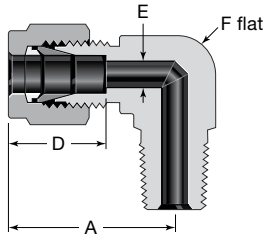

See page 8 for thread specifications.

### NPT

| Tube OD                | NPT Size    | Basic Ordering Number | Dimensions |      |                |         |
|------------------------|-------------|-----------------------|------------|------|----------------|---------|
|                        |             |                       | A          | D    | E <sup>①</sup> | F       |
| <b>Dimensions, in.</b> |             |                       |            |      |                |         |
| 1/16                   | 1/16<br>1/8 | -100-2-1<br>-100-2-2  | 0.75       | 0.34 | 0.05           | 7/16    |
| 1/8                    | 1/16        | -200-2-1              | 0.93       | 0.50 | 0.09           | 7/16    |
|                        | 1/8         | -200-2-2              | 0.93       |      |                | 7/16    |
|                        | 1/4         | -200-2-4              | 0.97       |      |                | 1/2     |
| 3/16                   | 1/8         | -300-2-2              | 1.00       | 0.54 | 0.12           | 1/2     |
|                        | 1/4         | -300-2-4              |            |      |                |         |
|                        |             |                       |            |      |                |         |
| 1/4                    | 1/16        | -400-2-1              | 1.06       | 0.60 | 0.12           | 1/2     |
|                        | 1/8         | -400-2-2              |            |      |                | 1/2     |
|                        | 1/4         | -400-2-4              |            |      |                | 1/2     |
|                        | 3/8         | -400-2-6              |            |      |                | 11/16   |
|                        | 1/2         | -400-2-8              |            |      |                | 13/16   |
| 5/16                   | 1/8         | -500-2-2              | 1.13       | 0.64 | 0.19           | 9/16    |
|                        | 1/4         | -500-2-4              |            |      |                | 9/16    |
|                        | 3/8         | -500-2-6              |            |      |                | 11/16   |
| 3/8                    | 1/8         | -600-2-2              | 1.20       | 0.66 | 0.19           | 5/8     |
|                        | 1/4         | -600-2-4              |            |      |                | 5/8     |
|                        | 3/8         | -600-2-6              |            |      |                | 11/16   |
|                        | 1/2         | -600-2-8              |            |      |                | 13/16   |
|                        | 3/4         | -600-2-12             |            |      |                | 1 1/16  |
| 1/2                    | 1/4         | -810-2-4              | 1.42       | 0.90 | 0.28           | 13/16   |
|                        | 3/8         | -810-2-6              |            |      |                | 13/16   |
|                        | 1/2         | -810-2-8              |            |      |                | 13/16   |
|                        | 3/4         | -810-2-12             |            |      |                | 1 1/16  |
| 5/8                    | 3/8         | -1010-2-6             | 1.50       | 0.96 | 0.38           | 15/16   |
|                        | 1/2         | -1010-2-8             |            |      |                | 15/16   |
|                        | 3/4         | -1010-2-12            |            |      |                | 1 1/16  |
| 3/4                    | 1/2         | -1210-2-8             | 1.57       | 0.96 | 0.47           | 1 1/16  |
|                        | 3/4         | -1210-2-12            |            |      |                |         |
| 7/8                    | 3/4         | -1410-2-12            | 1.76       | 1.02 | 0.62           | 1 3/8   |
| 1                      | 3/4         | -1610-2-12            | 1.93       | 1.23 | 0.62           | 1 3/8   |
|                        | 1           | -1610-2-16            |            |      |                |         |
| 1 1/4                  | 1 1/4       | -2000-2-20            | 2.67       | 1.62 | 1.09           | 1 11/16 |
| 1 1/2                  | 1 1/2       | -2400-2-24            | 3.10       | 1.97 | 1.34           | 2       |
| 2                      | 2           | -3200-2-32            | 4.22       | 2.66 | 1.81           | 2 3/4   |

① The E dimension is the minimum nominal opening. These fittings may have a larger opening at the pipe/straight thread end.

| Tube OD               | NPT Size in. | Basic Ordering Number | Dimensions |      |                |        |
|-----------------------|--------------|-----------------------|------------|------|----------------|--------|
|                       |              |                       | A          | D    | E <sup>①</sup> | F, in. |
| <b>Dimensions, mm</b> |              |                       |            |      |                |        |
| 3                     | 1/8          | -3M0-2-2              | 23.6       | 12.9 | 2.4            | 7/16   |
|                       | 1/4          | -3M0-2-4              | 24.6       |      |                | 1/2    |
| 4                     | 1/8          | -4M0-2-2              | 25.4       | 13.7 | 2.4            | 1/2    |
|                       | 1/4          | -4M0-2-4              |            |      |                |        |
| 6                     | 1/8          | -6M0-2-2              | 27.0       | 15.3 | 4.8            | 1/2    |
|                       | 1/4          | -6M0-2-4              |            |      |                | 1/2    |
|                       | 3/8          | -6M0-2-6              |            |      |                | 11/16  |
|                       | 1/2          | -6M0-2-8              |            |      |                | 13/16  |
| 8                     | 1/8          | -8M0-2-2              | 28.8       | 16.2 | 4.8            | 9/16   |
|                       | 1/4          | -8M0-2-4              |            |      |                | 9/16   |
|                       | 3/8          | -8M0-2-6              |            |      |                | 11/16  |
|                       | 1/2          | -8M0-2-8              |            |      |                | 13/16  |
|                       |              |                       |            |      |                |        |
| 10                    | 1/8          | -10M0-2-2             | 31.5       | 17.2 | 4.8            | 11/16  |
|                       | 1/4          | -10M0-2-4             |            |      |                | 11/16  |
|                       | 3/8          | -10M0-2-6             |            |      |                | 11/16  |
|                       | 1/2          | -10M0-2-8             |            |      |                | 13/16  |
| 12                    | 1/4          | -12M0-2-4             | 36.0       | 22.8 | 7.1            | 13/16  |
|                       | 3/8          | -12M0-2-6             |            |      |                | 13/16  |
|                       | 1/2          | -12M0-2-8             |            |      |                | 13/16  |
|                       | 3/4          | -12M0-2-12            |            |      |                | 13/16  |
|                       |              |                       |            |      |                |        |
| 15                    | 1/2          | -15M0-2-8             | 38.0       | 24.4 | 11.9           | 15/16  |
| 16                    | 3/8          | -16M0-2-6             | 38.0       | 24.4 | 9.5            | 15/16  |
|                       | 1/2          | -16M0-2-8             |            |      |                | 15/16  |
|                       | 3/4          | -16M0-2-12            |            |      |                | 1 1/16 |
| 18                    | 1/2          | -18M0-2-8             | 39.8       | 24.4 | 11.9           | 1 1/16 |
|                       | 3/4          | -18M0-2-12            |            |      |                |        |
| 20                    | 1/2          | -20M0-2-8             | 44.6       | 26.0 | 11.9           | 1 3/8  |
|                       | 3/4          | -20M0-2-12            |            |      |                |        |
| 22                    | 3/4          | -22M0-2-12            | 44.6       | 26.0 | 15.9           | 1 3/8  |
|                       | 1            | -22M0-2-16            |            |      |                |        |
| 25                    | 3/4          | -25M0-2-12            | 49.1       | 31.3 | 15.9           | 1 3/8  |
|                       | 1            | -25M0-2-16            |            |      |                |        |
| 30                    | 1 1/4        | -30M0-2-20            | 69.9       | 39.6 | 26.2           | 46 mm  |
| 32                    | 1 1/4        | -32M0-2-20            | 72.3       | 42.0 | 27.8           | 46 mm  |
| 38                    | 1 1/2        | -38M0-2-24            | 84.0       | 49.4 | 33.7           | 55 mm  |

① The E dimension is the minimum nominal opening. These fittings may have a larger opening at the pipe/straight thread end.

## 90° Elbows

### Male

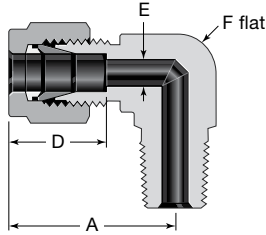

See page 8 for thread specifications.

### ISO/BSP Tapered Thread (RT)

| Tube OD                | ISO Thread Size | Basic Ordering Number    | Dimensions   |      |                |             |
|------------------------|-----------------|--------------------------|--------------|------|----------------|-------------|
|                        |                 |                          | A            | D    | E <sup>①</sup> | F           |
| <b>Dimensions, in.</b> |                 |                          |              |      |                |             |
| 1/8                    | 1/8<br>1/4      | -200-2-2RT<br>-200-2-4RT | 0.83<br>0.97 | 0.50 | 0.09           | 7/16<br>1/2 |
| 1/4                    | 1/8             | -400-2-2RT               | 1.06         | 0.60 | 0.19           | 1/2         |
|                        | 1/4             | -400-2-4RT               | 1.06         |      |                | 1/2         |
|                        | 3/8             | -400-2-6RT               | 1.17         |      |                | 11/16       |
|                        | 1/2             | -400-2-8RT               | 1.25         |      |                | 13/16       |
| 5/16                   | 1/4             | -500-2-4RT               | 1.13         | 0.64 | 0.25           | 9/16        |
| 3/8                    | 1/8             | -600-2-2RT               | 1.20         | 0.66 | 0.28           | 5/8         |
|                        | 1/4             | -600-2-4RT               | 1.20         |      |                | 5/8         |
|                        | 3/8             | -600-2-6RT               | 1.23         |      |                | 11/16       |
| 1/2                    | 1/4             | -810-2-4RT               | 1.42         | 0.90 | 0.28           | 13/16       |
|                        | 3/8             | -810-2-6RT               |              |      | 0.38           |             |
|                        | 1/2             | -810-2-8RT               |              |      | 0.41           |             |
|                        |                 |                          |              |      |                |             |
| 3/4                    | 1/2             | -1210-2-8RT              | 1.57         | 0.96 | 0.47           | 1 3/8       |
| 1                      | 1               | -1610-2-16RT             | 1.93         | 1.23 | 0.88           | 1 3/8       |

① The E dimension is the minimum nominal opening. These fittings may have a larger opening at the pipe/straight thread end.

| Tube OD               | ISO Thread Size in. | Basic Ordering Number | Dimensions |      |                |        |
|-----------------------|---------------------|-----------------------|------------|------|----------------|--------|
|                       |                     |                       | A          | D    | E <sup>①</sup> | F      |
| <b>Dimensions, mm</b> |                     |                       |            |      |                |        |
| 3                     | 1/8                 | -3M0-2-2RT            | 23.6       | 12.9 | 2.4            | 7/16   |
|                       | 1/4                 | -3M0-2-4RT            | 24.6       |      |                | 1/2    |
| 4                     | 1/8                 | -4M0-2-2RT            | 25.4       | 13.7 | 2.4            | 1/2    |
|                       | 1/4                 | -4M0-2-4RT            |            |      |                |        |
| 6                     | 1/8                 | -6M0-2-2RT            | 27.0       | 15.3 | 4.8            | 1/2    |
|                       | 1/4                 | -6M0-2-4RT            | 27.0       |      |                | 1/2    |
|                       | 3/8                 | -6M0-2-6RT            | 29.8       |      |                | 11/16  |
|                       | 1/2                 | -6M0-2-8RT            | 31.8       |      |                | 13/16  |
| 8                     | 1/8                 | -8M0-2-2RT            | 28.8       | 16.2 | 4.8            | 9/16   |
|                       | 1/4                 | -8M0-2-4RT            | 28.8       |      |                | 9/16   |
|                       | 3/8                 | -8M0-2-6RT            | 30.6       |      |                | 11/16  |
|                       | 1/2                 | -8M0-2-8RT            | 32.6       |      |                | 13/16  |
| 10                    | 1/4                 | -10M0-2-4RT           | 31.5       | 17.2 | 7.1            | 11/16  |
|                       | 3/8                 | -10M0-2-6RT           | 31.5       |      |                | 11/16  |
|                       | 1/2                 | -10M0-2-8RT           | 33.5       |      |                | 13/16  |
| 12                    | 1/8                 | -12M0-2-2RT           | 36.0       | 22.8 | 4.8            | 13/16  |
|                       | 1/4                 | -12M0-2-4RT           | 36.0       |      |                | 13/16  |
|                       | 3/8                 | -12M0-2-6RT           | 36.0       |      |                | 13/16  |
|                       | 1/2                 | -12M0-2-8RT           | 36.0       |      |                | 13/16  |
|                       | 3/4                 | -12M0-2-12RT          | 39.8       |      |                | 1 1/16 |
| 14                    | 1/2                 | -14M0-2-8RT           | 38.1       | 24.4 | 11.1           | 15/16  |
| 15                    | 1/2                 | -15M0-2-8RT           | 38.1       | 24.4 | 11.9           | 15/16  |
| 16                    | 3/8                 | -16M0-2-6RT           | 38.0       | 24.4 | 9.5            | 15/16  |
|                       | 1/2                 | -16M0-2-8RT           |            |      | 11.9           |        |
| 18                    | 1/2                 | -18M0-2-8RT           | 39.8       | 24.4 | 11.9           | 1 1/16 |
|                       | 3/4                 | -18M0-2-12RT          |            |      | 15.1           |        |
| 20                    | 1/2                 | -20M0-2-8RT           | 44.6       | 26.0 | 11.9           | 1 3/8  |
|                       | 3/4                 | -20M0-2-12RT          |            |      | 15.9           |        |
| 22                    | 3/4                 | -22M0-2-12RT          | 44.6       | 26.0 | 15.9           | 1 3/8  |
|                       | 1                   | -22M0-2-16RT          |            |      | 18.3           |        |
| 25                    | 3/4                 | -25M0-2-12RT          | 49.1       | 31.3 | 15.9           | 1 3/8  |
|                       | 1                   | -25M0-2-16RT          |            |      | 21.8           |        |
| 28                    | 1                   | -28M0-2-16RT          | 64.0       | 36.6 | 21.8           | 41 mm  |

① The E dimension is the minimum nominal opening. These fittings may have a larger opening at the pipe/straight thread end.

### Reducing

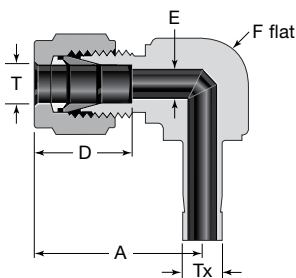

| Tube OD               |    | Basic Ordering Number | Dimensions |      |     |        |
|-----------------------|----|-----------------------|------------|------|-----|--------|
| T                     | Tx |                       | A          | D    | E   | F, in. |
| <b>Dimensions, mm</b> |    |                       |            |      |     |        |
| 6                     | 6  | -6M0-2R-6M            | 27.0       | 15.3 | 4.6 | 1/2    |
| 12                    | 12 | -12M0-2R-12M          | 38.1       | 22.8 | 8.8 | 15/16  |

## 90° Elbows

### Male

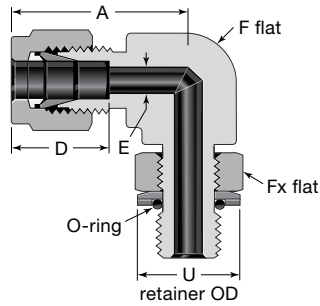

### Positionable, ISO/BSP Parallel Thread (PR)

| Tube OD                | ISO Thread Size in. | Basic Ordering Number    | Dimensions   |      |                |              |             |              |
|------------------------|---------------------|--------------------------|--------------|------|----------------|--------------|-------------|--------------|
|                        |                     |                          | A            | D    | E <sup>①</sup> | F, in.       | Fx, in.     | U            |
| <b>Dimensions, in.</b> |                     |                          |              |      |                |              |             |              |
| 1/4                    | 1/8<br>1/4          | -400-2-2PR<br>-400-2-4PR | 1.06<br>1.14 | 0.60 | 0.16<br>0.19   | 1/2<br>5/8   | 9/16<br>3/4 | 0.60<br>0.80 |
| 3/8                    | 1/4<br>3/8          | -600-2-4PR<br>-600-2-6PR | 1.20<br>1.31 | 0.66 | 0.23<br>0.28   | 5/8<br>13/16 | 3/4<br>7/8  | 0.80<br>0.96 |
| 1/2                    | 1/4                 | -810-2-4PR               | 1.42         | 0.90 | 0.23           | 13/16        | 3/4         | 0.80         |
|                        | 3/8                 | -810-2-6PR               | 1.42         |      | 0.31           | 13/16        | 7/8         | 0.96         |
|                        | 1/2                 | -810-2-8PR               | 1.50         |      | 0.41           | 15/16        | 1 1/16      | 1.16         |
| 5/8                    | 1/2                 | -1010-2-8PR              | 1.50         | 0.96 | 0.47           | 15/16        | 1 1/16      | 1.16         |
| 3/4                    | 1/2                 | -1210-2-8PR              | 1.57         | 0.96 | 0.47           | 1 1/16       | 1 1/16      | 1.16         |
|                        | 3/4                 | -1210-2-12PR             |              |      |                |              |             | 1.43         |
| 1                      | 3/4                 | -1610-2-12PR             | 1.93         | 1.23 | 0.62<br>0.78   | 1 3/8        | 1 3/8       | 1.43         |
|                        | 1                   | -1610-2-16PR             |              |      |                |              |             | 1.82         |
| <b>Dimensions, mm</b>  |                     |                          |              |      |                |              |             |              |
| 6                      | 1/8                 | -6M0-2-2PR               | 27.0         | 15.3 | 4.0            | 1/2          | 9/16        | 15.2         |
|                        | 1/4                 | -6M0-2-4PR               | 29.0         |      | 4.8            | 5/8          | 3/4         | 20.3         |
| 8                      | 1/8                 | -8M0-2-2PR               | 28.8         | 16.2 | 4.0            | 9/16         | 9/16        | 15.2         |
|                        | 1/4                 | -8M0-2-4PR               | 29.9         |      | 5.9            | 5/8          | 3/4         | 20.3         |
| 10                     | 1/4                 | -10M0-2-4PR              | 33.5         | 17.2 | 5.9            | 13/16        | 3/4         | 20.3         |
|                        | 3/8                 | -10M0-2-6PR              |              |      | 7.9            | 7/8          | 7/8         | 24.4         |
| 12                     | 1/4                 | -12M0-2-4PR              | 36.0         | 22.8 | 5.9            | 13/16        | 3/4         | 20.3         |
|                        | 3/8                 | -12M0-2-6PR              | 36.0         |      | 7.9            | 13/16        | 7/8         | 24.4         |
|                        | 1/2                 | -12M0-2-8PR              | 38.0         |      | 9.5            | 15/16        | 1 1/16      | 29.5         |
|                        | 3/4                 | -12M0-2-12PR             | 39.8         |      | 9.5            | 1 1/16       | 1 3/8       | 36.3         |

① The E dimension is the minimum nominal opening. These fittings may have a larger opening at the pipe/straight thread end.

### Positionable, SAE/MS Straight Thread (ST)

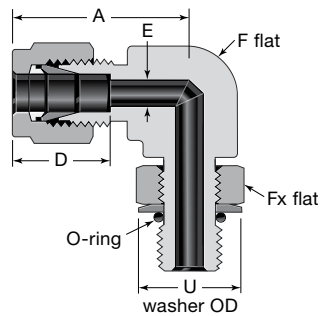

SAE/MS positionable fittings are available in carbon steel and stainless steel only. Adapts to SAE J1926/1 and ISO 11926-1 straight thread boss.

| Tube OD                | SAE/MS Thread Size | Basic Ordering Number | Dimensions |      |                      |         |              |       |      |
|------------------------|--------------------|-----------------------|------------|------|----------------------|---------|--------------|-------|------|
|                        |                    |                       | A          | D    | E <sup>①</sup>       | F, in.  | Fx, in.      | U     |      |
| <b>Dimensions, in.</b> |                    |                       |            |      |                      |         |              |       |      |
| 1/4                    | 7/16-20            | -400-2-4ST            | 1.12       | 0.60 | 0.19                 | 1/2     | 9/16         | 0.65  |      |
|                        | 9/16-18            | -400-2-6ST            | 1.20       |      |                      |         |              | 11/16 | 0.79 |
| 5/16                   | 1/2-20             | -500-2-5ST            | 1.19       | 0.64 | 0.23                 | 9/16    | 5/8          | 0.72  |      |
| 3/8                    | 7/16-20            | -600-2-4ST            | 1.26       | 0.66 | 0.20<br>0.28<br>0.28 | 5/8     | 9/16         | 0.65  |      |
|                        | 9/16-18            | -600-2-6ST            | 1.26       |      |                      |         |              | 11/16 | 0.79 |
|                        | 3/4-16             | -600-2-8ST            | 1.37       |      |                      |         |              | 7/8   | 1.01 |
| 1/2                    | 9/16-18            | -810-2-6ST            | 1.48       | 0.90 | 0.28<br>0.41         | 13/16   | 11/16<br>7/8 | 0.79  |      |
|                        | 3/4-16             | -810-2-8ST            |            |      |                      |         |              | 1.01  |      |
| 5/8                    | 7/8-14             | -1010-2-10ST          | 1.56       | 0.96 | 0.50                 | 15/16   | 1            | 1.16  |      |
| 3/4                    | 1 1/16-12          | -1210-2-12ST          | 1.63       | 0.96 | 0.62                 | 1 1/16  | 1 1/4        | 1.44  |      |
| 7/8                    | 1 3/16-12          | -1410-2-14ST          | 1.70       | 1.02 | 0.72                 | 1 3/16  | 1 3/8        | 1.59  |      |
| 1                      | 1 5/16-12          | -1610-2-16ST          | 1.99       | 1.23 | 0.88                 | 1 3/8   | 1 1/2        | 1.73  |      |
| 1 1/4                  | 1 5/8-12           | -2000-2-20ST          | 2.67       | 1.62 | 1.09                 | 1 11/16 | 1 7/8        | 2.16  |      |
| 1 1/2                  | 1 7/8-12           | -2400-2-24ST          | 3.07       | 1.97 | 1.34                 | 2       | 2 1/8        | 2.45  |      |
| 2                      | 2 1/2-12           | -3200-2-32ST          | 4.22       | 2.66 | 1.81                 | 2 3/4   | 2 3/4        | 3.16  |      |

① The E dimension is the minimum nominal opening. These fittings may have a larger opening at the pipe/straight thread end.



## 90° Elbows

### Weld

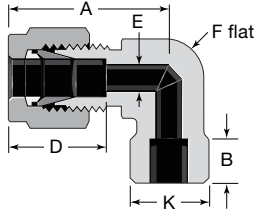

### Tube Socket Weld

| Tube OD         | Socket Weld Size | Basic Ordering Number | Dimensions |      |      |      |        |      |
|-----------------|------------------|-----------------------|------------|------|------|------|--------|------|
|                 |                  |                       | A          | B    | D    | E    | F      | K    |
| Dimensions, in. |                  |                       |            |      |      |      |        |      |
| 1/4             | 1/4              | -400-9-4W             | 1.06       | 0.28 | 0.60 | 0.19 | 1/2    | 0.50 |
| 3/8             | 3/8              | -600-9-6W             | 1.20       | 0.31 | 0.66 | 0.28 | 5/8    | 0.63 |
| 1/2             | 1/2              | -810-9-8W             | 1.42       | 0.38 | 0.90 | 0.41 | 13/16  | 0.81 |
| 3/4             | 3/4              | -1210-9-12W           | 1.57       | 0.44 | 0.96 | 0.62 | 1 1/16 | 1.06 |
| 1               | 1                | -1610-9-16W           | 1.93       | 0.62 | 1.23 | 0.88 | 1 3/8  | 1.38 |

### Male Pipe Weld

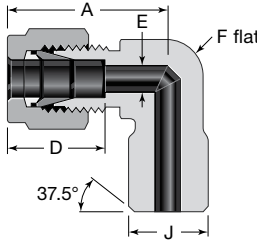

| Tube OD         | Pipe Weld Size | Basic Ordering Number  | Dimensions |      |                |        |                |
|-----------------|----------------|------------------------|------------|------|----------------|--------|----------------|
|                 |                |                        | A          | D    | E <sup>①</sup> | F      | J              |
| Dimensions, in. |                |                        |            |      |                |        |                |
| 1/4             | 1/8<br>1/4     | -400-2-2W<br>-400-2-4W | 1.06       | 0.60 | 0.19           | 1/2    | 0.405<br>0.540 |
| 3/8             | 1/4            | -600-2-4W              | 1.20       | 0.66 | 0.28           | 5/8    | 0.540          |
| 1/2             | 1/2            | -810-2-8W              | 1.42       | 0.90 | 0.41           | 13/16  | 0.840          |
| 3/4             | 3/4            | -1210-2-12W            | 1.57       | 0.96 | 0.62           | 1 1/16 | 1.050          |

① The E dimension is the minimum nominal opening. These fittings may have a larger opening at the weld end. Wall thickness at the weld end is based on schedule 80 pipe.

### Female

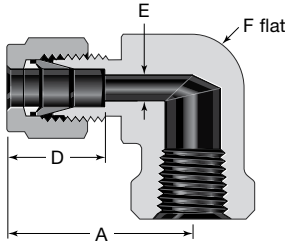

### NPT

| Tube OD         | NPT Size   | Basic Ordering Number | Dimensions   |      |      |              |
|-----------------|------------|-----------------------|--------------|------|------|--------------|
|                 |            |                       | A            | D    | E    | F            |
| Dimensions, in. |            |                       |              |      |      |              |
| 1/8             | 1/8<br>1/4 | -200-8-2<br>-200-8-4  | 0.97<br>1.08 | 0.50 | 0.09 | 1/2<br>11/16 |
| 3/16            | 1/8        | -300-8-2              | 1.00         | 0.54 | 0.12 | 1/2          |
| 1/4             | 1/8        | -400-8-2              | 1.06         | 0.60 | 0.19 | 1/2          |
|                 | 1/4        | -400-8-4              | 1.17         |      |      | 11/16        |
|                 | 3/8        | -400-8-6              | 1.25         |      |      | 13/16        |
|                 | 1/2        | -400-8-8              | 1.36         |      |      | 1            |
| 5/16            | 1/8        | -500-8-2              | 1.13         | 0.64 | 0.25 | 9/16         |
|                 | 1/4        | -500-8-4              | 1.20         |      |      | 11/16        |
| 3/8             | 1/8        | -600-8-2              | 1.20         | 0.66 | 0.28 | 5/8          |
|                 | 1/4        | -600-8-4              | 1.23         |      |      | 11/16        |
|                 | 3/8        | -600-8-6              | 1.31         |      |      | 13/16        |
|                 | 1/2        | -600-8-8              | 1.42         |      |      | 1            |
| 1/2             | 1/4        | -810-8-4              | 1.42         | 0.90 | 0.41 | 13/16        |
|                 | 3/8        | -810-8-6              | 1.42         |      |      | 13/16        |
|                 | 1/2        | -810-8-8              | 1.53         |      |      | 1            |
| 5/8             | 3/8        | -1010-8-6             | 1.50         | 0.96 | 0.50 | 15/16        |
|                 | 1/2        | -1010-8-8             | 1.57         |      |      | 1 1/16       |
| 3/4             | 1/2        | -1210-8-8             | 1.57         | 0.96 | 0.62 | 1 1/16       |
|                 | 3/4        | -1210-8-12            | 1.76         |      |      | 1 3/8        |
| 7/8             | 3/4        | -1410-8-12            | 1.76         | 1.02 | 0.72 | 1 3/8        |
| 1               | 3/4        | -1610-8-12            | 1.93         | 1.23 | 0.88 | 1 3/8        |
|                 | 1          | -1610-8-16            | 2.11         |      |      | 1 11/16      |

| Tube OD        | NPT Size in. | Basic Ordering Number | Dimensions |      |      |        |
|----------------|--------------|-----------------------|------------|------|------|--------|
|                |              |                       | A          | D    | E    | F, in. |
| Dimensions, mm |              |                       |            |      |      |        |
| 6              | 1/8          | -6M0-8-2              | 27.0       | 15.3 | 4.8  | 1/2    |
|                | 1/4          | -6M0-8-4              | 29.8       |      |      | 11/16  |
|                | 1/2          | -6M0-8-8              | 34.6       |      |      | 1      |
| 8              | 1/4          | -8M0-8-4              | 30.6       | 16.2 | 6.4  | 11/16  |
| 10             | 1/8          | -10M0-8-2             | 31.5       | 17.2 | 7.9  | 11/16  |
|                | 1/4          | -10M0-8-4             | 33.5       |      |      | 13/16  |
| 12             | 1/4          | -12M0-8-4             | 36.0       | 22.8 | 9.5  | 13/16  |
|                | 1/2          | -12M0-8-8             | 38.8       |      |      | 1      |
| 16             | 1/2          | -16M0-8-8             | 39.5       | 24.4 | 12.7 | 1 1/16 |

## 45° Elbows

### Male

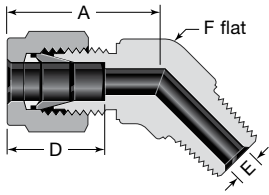

### NPT

| Tube OD         | NPT Size   | Basic Ordering Number | Dimensions   |      |                |              |
|-----------------|------------|-----------------------|--------------|------|----------------|--------------|
|                 |            |                       | A            | D    | E <sup>①</sup> | F            |
| Dimensions, in. |            |                       |              |      |                |              |
| 1/4             | 1/8<br>1/4 | -400-5-2<br>-400-5-4  | 0.97         | 0.60 | 0.19           | 1/2          |
| 3/8             | 1/8        | -600-5-2              | 1.10         | 0.66 | 0.19           | 5/8          |
|                 | 1/4<br>3/8 | -600-5-4<br>-600-5-6  | 1.10<br>1.15 |      | 0.28<br>0.28   | 5/8<br>13/16 |
| 1/2             | 3/8        | -810-5-6              | 1.26         | 0.90 | 0.38           | 13/16        |
|                 | 1/2        | -810-5-8              |              |      | 0.41           |              |
| 3/4             | 3/4        | -1210-5-12            | 1.33         | 0.96 | 0.62           | 1 1/16       |
| 1               | 1          | -1610-5-16            | 1.59         | 1.23 | 0.88           | 1 3/8        |

① The E dimension is the minimum nominal opening. These fittings may have a larger opening at the pipe/straight thread end.

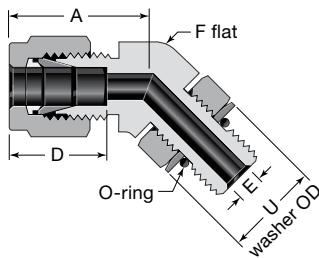

### Positionable, SAE/MS Straight Thread (ST)

| Tube OD         | SAE/MS Thread Size | Basic Ordering Number | Dimensions |      |                |        |      |
|-----------------|--------------------|-----------------------|------------|------|----------------|--------|------|
|                 |                    |                       | A          | D    | E <sup>①</sup> | F      | U    |
| Dimensions, in. |                    |                       |            |      |                |        |      |
| 1/4             | 7/16-20            | -400-5-4ST            | 1.01       | 0.60 | 0.19           | 1/2    | 0.65 |
| 3/8             | 9/16-18            | -600-5-6ST            | 1.10       | 0.66 | 0.28           | 5/8    | 0.79 |
|                 |                    | -810-5-8ST            |            |      |                |        |      |
| 1/2             | 3/4-16             | -810-5-8ST            | 1.26       | 0.90 | 0.41           | 13/16  | 1.01 |
| 3/4             | 1 1/16-12          | -1210-5-12ST          | 1.33       | 0.96 | 0.62           | 1 1/16 | 1.44 |
| 1               | 1 5/16-12          | -1610-5-16ST          | 1.59       | 1.23 | 0.88           | 1 3/8  | 1.73 |

① The E dimension is the minimum nominal opening. These fittings may have a larger opening at the pipe/straight thread end.

SAE/MS positionable fittings are available in carbon steel and stainless steel only. Adapts to SAE J1926/1 and ISO 11926-1 straight thread boss.

## Tees

### Unions

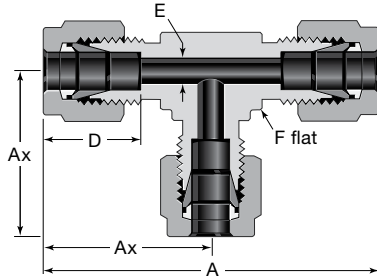

### Union

| Tube OD         | Basic Ordering Number | Dimensions |      |      |      |         |
|-----------------|-----------------------|------------|------|------|------|---------|
|                 |                       | A          | Ax   | D    | E    | F       |
| Dimensions, in. |                       |            |      |      |      |         |
| 1/16            | -100-3                | 1.40       | 0.70 | 0.34 | 0.05 | 3/8     |
| 1/8             | -200-3                | 1.76       | 0.88 | 0.50 | 0.09 | 3/8     |
| 3/16            | -300-3                | 1.92       | 0.96 | 0.54 | 0.12 | 7/16    |
| 1/4             | -400-3                | 2.12       | 1.06 | 0.60 | 0.19 | 1/2     |
| 5/16            | -500-3                | 2.34       | 1.17 | 0.64 | 0.25 | 5/8     |
| 3/8             | -600-3                | 2.40       | 1.20 | 0.66 | 0.28 | 5/8     |
| 1/2             | -810-3                | 2.84       | 1.42 | 0.90 | 0.41 | 13/16   |
| 5/8             | -1010-3               | 3.06       | 1.53 | 0.96 | 0.50 | 1       |
| 3/4             | -1210-3               | 3.14       | 1.57 | 0.96 | 0.62 | 1 1/16  |
| 7/8             | -1410-3               | 3.52       | 1.76 | 1.02 | 0.72 | 1 3/8   |
| 1               | -1610-3               | 3.86       | 1.93 | 1.23 | 0.88 | 1 3/8   |
| 1 1/8           | -1810-3               | 4.34       | 2.17 | 1.23 | 0.97 | 1 11/16 |
| 1 1/4           | -2000-3               | 5.34       | 2.67 | 1.62 | 1.09 | 1 11/16 |
| 1 1/2           | -2400-3               | 6.20       | 3.10 | 1.97 | 1.34 | 2       |
| 2               | -3200-3               | 8.44       | 4.22 | 2.66 | 1.81 | 2 3/4   |

| Tube OD        | Basic Ordering Number | Dimensions |      |      |      |        |
|----------------|-----------------------|------------|------|------|------|--------|
|                |                       | A          | Ax   | D    | E    | F, in. |
| Dimensions, mm |                       |            |      |      |      |        |
| 2              | -2M0-3                | 44.7       | 22.3 | 12.9 | 1.7  | 3/8    |
| 3              | -3M0-3                | 44.7       | 22.3 | 12.9 | 2.4  | 3/8    |
| 4              | -4M0-3                | 50.8       | 25.4 | 13.7 | 2.4  | 1/2    |
| 6              | -6M0-3                | 53.9       | 27.0 | 15.3 | 4.8  | 1/2    |
| 8              | -8M0-3                | 59.7       | 29.9 | 16.2 | 6.4  | 5/8    |
| 10             | -10M0-3               | 63.0       | 31.5 | 17.2 | 7.9  | 11/16  |
| 12             | -12M0-3               | 72.0       | 36.0 | 22.8 | 9.5  | 13/16  |
| 14             | -14M0-3               | 77.6       | 38.8 | 24.4 | 11.1 | 1      |
| 15             | -15M0-3               | 77.6       | 38.8 | 24.4 | 11.9 | 1      |
| 16             | -16M0-3               | 77.6       | 38.8 | 24.4 | 12.7 | 1      |
| 18             | -18M0-3               | 79.6       | 39.8 | 24.4 | 15.1 | 1 1/16 |
| 20             | -20M0-3               | 89.3       | 44.6 | 26.0 | 15.9 | 1 3/8  |
| 22             | -22M0-3               | 89.3       | 44.6 | 26.0 | 18.3 | 1 3/8  |
| 25             | -25M0-3               | 98.3       | 49.1 | 31.3 | 21.8 | 1 3/8  |
| 28             | -28M0-3               | 128        | 64.0 | 36.6 | 21.8 | 41 mm  |
| 30             | -30M0-3               | 140        | 69.9 | 39.6 | 26.2 | 46 mm  |
| 32             | -32M0-3               | 145        | 72.3 | 42.0 | 28.6 | 46 mm  |
| 38             | -38M0-3               | 168        | 84.0 | 49.4 | 33.7 | 55 mm  |
| 50             | -50M0-3               | 211        | 106  | 65.0 | 45.2 | 2 3/4  |

### Reducing Union (Fractional)

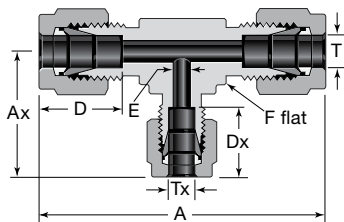

| Tube OD         |     | Basic Ordering Number | Dimensions |      |      |      |      |         |
|-----------------|-----|-----------------------|------------|------|------|------|------|---------|
| T               | Tx  |                       | A          | Ax   | D    | Dx   | E    | F       |
| Dimensions, in. |     |                       |            |      |      |      |      |         |
| 3/8             | 1/4 | -600-3-6-4            | 2.40       | 1.14 | 0.66 | 0.60 | 0.19 | 5/8     |
| 1/2             | 1/4 | -810-3-8-4            | 2.84       | 1.25 | 0.90 | 0.60 | 0.19 | 13/16   |
|                 | 3/8 | -810-3-8-6            |            | 1.31 |      | 0.66 | 0.28 |         |
| 5/8             | 3/8 | -1010-3-10-6          | 3.06       | 1.42 | 0.96 | 0.66 | 0.28 | 1       |
| 3/4             | 3/8 | -1210-3-12-6          | 3.14       | 1.46 | 0.96 | 0.66 | 0.28 | 1 1/16  |
|                 | 1/2 | -1210-3-12-8          |            | 1.57 |      | 0.90 | 0.41 |         |
| 1               | 3/8 | -1610-3-16-6          | 3.86       | 1.65 | 1.23 | 0.66 | 0.28 | 1 3/8   |
|                 | 1/2 | -1610-3-16-8          |            | 1.76 |      | 0.90 | 0.41 |         |
|                 | 3/4 | -1610-3-16-12         |            | 1.76 |      | 0.96 | 0.62 |         |
| 1 1/4           | 1   | -2000-3-20-16         | 5.34       | 2.17 | 1.62 | 1.23 | 0.88 | 1 11/16 |
| 1 1/2           | 1   | -2400-3-24-16         | 6.20       | 2.36 | 1.97 | 1.23 | 0.88 | 2       |
| 2               | 1   | -3200-3-32-16         | 8.44       | 2.79 | 2.66 | 1.23 | 0.88 | 2 3/4   |

**Tees**

**Unions**

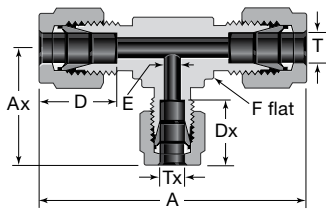

**Reducing Union (Metric)**

| Tube OD               |    | Basic Ordering Number | Dimensions |      |      |      |     |        |
|-----------------------|----|-----------------------|------------|------|------|------|-----|--------|
| T                     | Tx |                       | A          | Ax   | D    | Dx   | E   | F, in. |
| <b>Dimensions, mm</b> |    |                       |            |      |      |      |     |        |
| 3                     | 6  | -3M0-3-3M-6M          | 49.3       | 26.9 | 12.9 | 15.3 | 2.4 | 1/2    |
| 8                     |    | -8M0-3-8M-6M          | 59.9       | 29.0 | 16.2 | 15.3 | 4.8 | 5/8    |
| 10                    |    | -10M0-3-10M-6M        | 63.0       | 29.7 | 17.2 | 15.3 | 4.8 | 11/16  |
| 12                    |    | -12M0-3-12M-6M        | 72.0       | 31.8 | 22.8 | 15.3 | 4.8 | 13/16  |
| 15                    | 12 | -15M0-3-15M-12M       | 77.7       | 38.9 | 24.4 | 22.8 | 9.5 | 1      |
| 16                    |    | -16M0-3-16M-12M       | 77.6       | 38.9 | 24.4 | 22.8 | 9.5 | 1      |
| 18                    |    | -18M0-3-18M-12M       | 79.8       | 39.9 | 24.4 | 22.8 | 9.5 | 1 1/16 |
| 22                    |    | -22M0-3-22M-12M       | 89.4       | 44.7 | 26.0 | 22.8 | 9.5 | 1 3/8  |
| 25                    |    | -25M0-3-25M-12M       | 98.0       | 44.7 | 31.3 | 22.8 | 9.5 | 1 3/8  |

**Reducing Union**

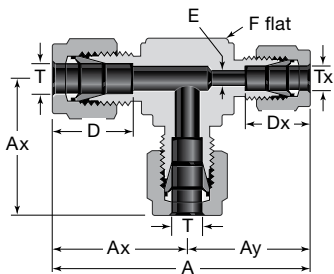

| Tube OD                |     | Basic Ordering Number | Dimensions |      |      |      |      |      |     |
|------------------------|-----|-----------------------|------------|------|------|------|------|------|-----|
| T                      | Tx  |                       | A          | Ax   | Ay   | D    | Dx   | E    | F   |
| <b>Dimensions, in.</b> |     |                       |            |      |      |      |      |      |     |
| 3/8                    | 1/4 | -600-3-4-6            | 2.34       | 1.20 | 1.14 | 0.66 | 0.60 | 0.19 | 5/8 |

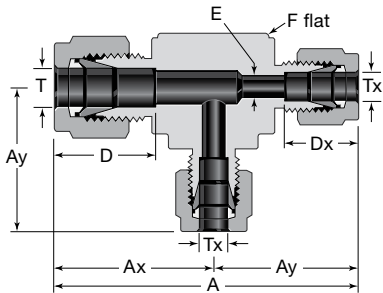

| Tube OD                |     | Basic Ordering Number | Dimensions |      |      |      |      |      |        |
|------------------------|-----|-----------------------|------------|------|------|------|------|------|--------|
| T                      | Tx  |                       | A          | Ax   | Ay   | D    | Dx   | E    | F      |
| <b>Dimensions, in.</b> |     |                       |            |      |      |      |      |      |        |
| 1/2                    | 3/8 | -810-3-6-6            | 2.73       | 1.42 | 1.31 | 0.90 | 0.66 | 0.28 | 13/16  |
| 5/8                    |     | -1010-3-6-6           | 2.95       | 1.53 | 1.42 | 0.96 | 0.66 | 0.28 | 1      |
| 3/4                    |     | -1210-3-6-6           | 3.03       | 1.57 | 1.46 | 0.96 | 0.66 | 0.28 | 1 1/16 |

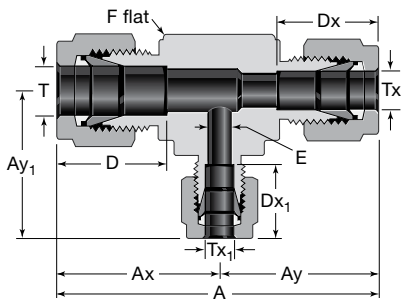

| Tube OD                |     |     | Basic Ordering Number | Dimensions |      |      |      |      |      |      |      |        |
|------------------------|-----|-----|-----------------------|------------|------|------|------|------|------|------|------|--------|
| T                      | Tx  | Tx1 |                       | A          | Ax   | Ay   | Ay1  | D    | Dx   | Dx1  | E    | F      |
| <b>Dimensions, in.</b> |     |     |                       |            |      |      |      |      |      |      |      |        |
| 5/8                    | 1/2 | 3/8 | -1010-3-8-6           | 3.06       | 1.53 | 1.53 | 1.42 | 0.96 | 0.90 | 0.66 | 0.28 | 1      |
| 3/4                    | 1/2 |     | -1210-3-8-6           | 3.14       | 1.57 | 1.57 | 1.46 | 0.96 | 0.90 |      |      | 1 1/16 |
| 1                      | 3/4 |     | -1610-3-12-6          | 3.69       | 1.93 | 1.76 | 1.65 | 1.23 | 0.96 |      |      | 1 3/8  |

**Tees**

**Male**

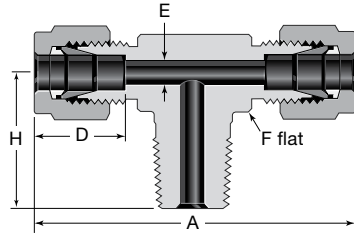

**Branch, NPT (TTM)**

| Tube OD                | NPT Size in.      | Basic Ordering Number                      | Dimensions   |      |                   |              |                      |
|------------------------|-------------------|--|--------------|------|-------------------|--------------|----------------------|
|                        |                   |  | A            | D    | E <sup>①</sup>    | F, in.       | H                    |
| <b>Dimensions, in.</b> |                   |  |              |      |                   |              |                      |
| 1/8                    | 1/8<br>1/4        | -200-3TTM<br>-200-3-4TTM                   | 1.86<br>1.94 | 0.50 | 0.09              | 7/16<br>1/2  | 0.70<br>0.92         |
| 3/16                   | 1/8               | -300-3TTM                                  | 1.92         | 0.54 | 0.12              | 7/16         | 0.70                 |
| 1/4                    | 1/8<br>1/4        | -400-3TTM<br>-400-3-4TTM                   | 2.12         | 0.60 | 0.19              | 1/2          | 0.74<br>0.92         |
| 5/16                   | 1/8               | -500-3TTM                                  | 2.34         | 0.64 | 0.19              | 5/8          | 0.82                 |
| 3/8                    | 1/4<br>3/8        | -600-3TTM<br>-600-3-6TTM                   | 2.40<br>2.62 | 0.66 | 0.28              | 5/8<br>13/16 | 1.00<br>1.11         |
| 1/2                    | 3/8<br>1/2        | -810-3TTM<br>-810-3-8TTM                   | 2.84         | 0.90 | 0.38<br>0.41      | 13/16        | 1.11<br>1.30         |
| 5/8                    | 1/2               | -1010-3TTM                                 | 3.06         | 0.96 | 0.47              | 1            | 1.41                 |
| 3/4                    | 3/4               | -1210-3TTM                                 | 3.14         | 0.96 | 0.62              | 1 1/16       | 1.45                 |
| <b>Dimensions, mm</b>  |                   |  |              |      |                   |              |                      |
| 6                      | 1/8<br>1/4        | -6M0-3TTM<br>-6M0-3-4TTM                   | 53.9         | 15.3 | 4.8               | 1/2          | 18.8<br>23.4         |
| 8                      | 1/8<br>1/4        | -8M0-3TTM<br>-8M0-3-4TTM                   | 59.7         | 16.2 | 4.8<br>6.4        | 5/8          | 20.8<br>25.4         |
| 10                     | 1/4               | -10M0-3TTM                                 | 67.0         | 17.2 | 7.1               | 13/16        | 26.2                 |
| 12                     | 3/8<br>1/4<br>1/2 | -12M0-3TTM<br>-12M0-3-4TTM<br>-12M0-3-8TTM | 72.0         | 22.8 | 9.5<br>7.1<br>9.5 | 13/16        | 28.2<br>28.2<br>33.0 |
| 16                     | 1/2               | -16M0-3TTM                                 | 77.6         | 24.4 | 11.9              | 1            | 35.8                 |

① The E dimension is the minimum nominal opening. These fittings may have a larger opening at the pipe/straight thread end.

**Run, NPT (TMT)**

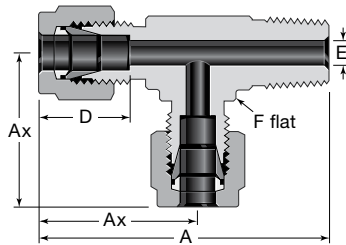

| Tube OD                | NPT Size in. | Basic Ordering Number        | Dimensions   |              |      |                |              |
|------------------------|--------------|------------------------------|--------------|--------------|------|----------------|--------------|
|                        |              |                              | A            | Ax           | D    | E <sup>①</sup> | F, in.       |
| <b>Dimensions, in.</b> |              |                              |              |              |      |                |              |
| 1/8                    | 1/8<br>1/4   | -200-3TMT<br>-200-3-4TMT     | 1.63<br>1.89 | 0.93<br>0.97 | 0.50 | 0.09           | 7/16<br>1/2  |
| 3/16                   | 1/8          | -300-3TMT                    | 1.66         | 0.96         | 0.54 | 0.12           | 7/16         |
| 1/4                    | 1/8<br>1/4   | -400-3TMT<br>-400-3-4TMT     | 1.80<br>1.98 | 1.06         | 0.60 | 0.19           | 1/2          |
| 5/16                   | 1/8          | -500-3TMT                    | 1.99         | 1.17         | 0.64 | 0.19           | 5/8          |
| 3/8                    | 1/4<br>3/8   | -600-3TMT<br>-600-3-6TMT     | 2.20<br>2.42 | 1.20<br>1.31 | 0.66 | 0.28           | 5/8<br>13/16 |
| 1/2                    | 3/8<br>1/2   | -810-3TMT<br>-810-3-8TMT     | 2.53<br>2.72 | 1.42         | 0.90 | 0.38<br>0.41   | 13/16        |
| 5/8                    | 1/2          | -1010-3TMT                   | 2.88         | 1.50         | 0.96 | 0.47           | 15/16        |
| 3/4                    | 3/4          | -1210-3TMT                   | 3.02         | 1.57         | 0.96 | 0.62           | 1 1/16       |
| <b>Dimensions, mm</b>  |              |                              |              |              |      |                |              |
| 6                      | 1/8<br>1/4   | -6M0-3TMT<br>-6M0-3-4TMT     | 45.8<br>50.3 | 27.0         | 15.3 | 4.8            | 1/2          |
| 8                      | 1/4          | -8M0-3-4TMT                  | 55.3         | 29.9         | 16.2 | 6.4            | 5/8          |
| 12                     | 1/4<br>1/2   | -12M0-3-4TMT<br>-12M0-3-8TMT | 64.2<br>69.0 | 36.0         | 22.8 | 7.1<br>9.5     | 13/16        |
| 16                     | 1/2          | -16M0-3TMT                   | 73.1         | 38.0         | 24.4 | 11.9           | 15/16        |

① The E dimension is the minimum nominal opening. These fittings may have a larger opening at the pipe/straight thread end.

**Tees**

**Male**

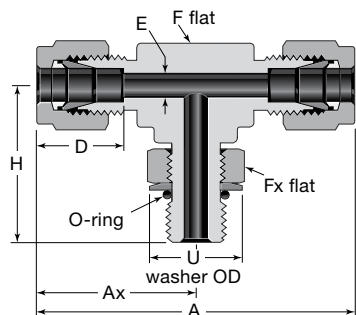

SAE/MS positionable fittings are available in carbon steel and stainless steel only.

Adapts to SAE J1926/1 and ISO 11926-1 straight thread boss.

**Positionable Branch, SAE/MS Straight Thread (TTS)**

| Tube OD                | SAE/MS Thread Size | Basic Ordering Number | Dimensions |      |      |                |         |       |      |      |
|------------------------|--------------------|-----------------------|------------|------|------|----------------|---------|-------|------|------|
|                        |                    |                       | A          | Ax   | D    | E <sup>①</sup> | F       | Fx    | H    | U    |
| <b>Dimensions, in.</b> |                    |                       |            |      |      |                |         |       |      |      |
| 1/4                    | 7/16-20            | -400-3TTS             | 2.24       | 1.12 | 0.60 | 0.19           | 1/2     | 9/16  | 1.12 | 0.65 |
| 3/8                    | 9/16-18            | -600-3TTS             | 2.52       | 1.26 | 0.66 | 0.28           | 5/8     | 11/16 | 1.27 | 0.79 |
| 1/2                    | 3/4-16             | -810-3TTS             | 2.96       | 1.48 | 0.90 | 0.41           | 13/16   | 7/8   | 1.49 | 1.01 |
| 3/4                    | 1 1/16-12          | -1210-3TTS            | 3.26       | 1.63 | 0.96 | 0.62           | 1 1/16  | 11/4  | 1.92 | 1.44 |
| 1                      | 1 5/16-12          | -1610-3TTS            | 3.98       | 1.99 | 1.23 | 0.88           | 1 3/8   | 1 1/2 | 2.11 | 1.73 |
| 1 1/4                  | 1 5/8-12           | -2000-3TTS            | 5.34       | 2.67 | 1.62 | 1.09           | 1 11/16 | 1 7/8 | 2.29 | 2.16 |
| 1 1/2                  | 1 7/8-12           | -2400-3TTS            | 6.14       | 3.07 | 1.97 | 1.34           | 2       | 2 1/8 | 2.45 | 2.45 |
| 2                      | 2 1/2-12           | -3200-3TTS            | 8.44       | 4.22 | 2.66 | 1.81           | 2 3/4   | 2 3/4 | 2.77 | 3.16 |

① The E dimension is the minimum nominal opening. These fittings may have a larger opening at the pipe/straight thread end.

**Positionable Branch, ISO/BSP Parallel Thread (TTR)**

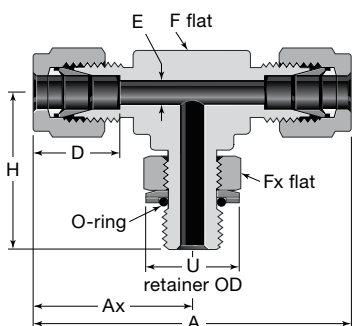

Tube ports are identical.

See page 8 for thread specifications.

| Tube OD                | ISO Thread Size in. | Basic Ordering Number | Dimensions |      |      |                |        |         |      |      |
|------------------------|---------------------|-----------------------|------------|------|------|----------------|--------|---------|------|------|
|                        |                     |                       | A          | Ax   | D    | E <sup>①</sup> | F, in. | Fx, in. | H    | U    |
| <b>Dimensions, in.</b> |                     |                       |            |      |      |                |        |         |      |      |
| 1/4                    | 1/8                 | -400-3TTR             | 2.12       | 1.06 | 0.60 | 0.16           | 1/2    | 9/16    | 1.04 | 0.60 |
|                        | 1/4                 | -400-3-4TTR           | 2.28       | 1.14 |      | 0.19           | 5/8    | 3/4     | 1.27 | 0.80 |
| 3/8                    | 1/4                 | -600-3TTR             | 2.40       | 1.20 | 0.66 | 0.23           | 5/8    | 3/4     | 1.27 | 0.80 |
| 1/2                    | 3/8                 | -810-3TTR             | 2.84       | 1.42 | 0.90 | 0.31           | 13/16  | 7/8     | 1.46 | 0.96 |
|                        | 1/2                 | -810-3-8TTR           | 3.00       | 1.50 |      | 0.41           | 15/16  | 1 1/16  | 1.71 | 1.16 |
| 5/8                    | 1/2                 | -1010-3TTR            | 3.00       | 1.50 | 0.96 | 0.47           | 15/16  | 1 1/16  | 1.71 | 1.16 |
| 3/4                    | 3/4                 | -1210-3TTR            | 3.14       | 1.57 | 0.96 | 0.62           | 1 1/16 | 1 3/8   | 1.92 | 1.43 |
|                        | 1/2                 | -1210-3-8TTR          |            |      |      | 0.47           |        | 1 1/16  | 1.78 | 1.16 |
| 1                      | 1                   | -1610-3TTR            | 3.86       | 1.93 | 1.23 | 0.78           | 1 3/8  | 1 5/8   | 2.11 | 1.92 |
| <b>Dimensions, mm</b>  |                     |                       |            |      |      |                |        |         |      |      |
| 6                      | 1/8                 | -6M0-3TTR             | 53.9       | 27.0 | 15.3 | 4.0            | 1/2    | 9/16    | 26.4 | 15.2 |
|                        | 1/4                 | -6M0-3-4TTR           | 58.0       | 29.0 |      | 4.8            | 5/8    | 3/4     | 32.2 | 20.3 |
| 8                      | 1/8                 | -8M0-3TTR             | 57.7       | 30.0 | 16.2 | 4.0            | 9/16   | 9/16    | 28.4 | 15.2 |
|                        | 1/4                 | -8M0-3-4TTR           | 59.7       |      |      | 5.9            | 5/8    | 3/4     | 32.3 | 20.3 |
| 10                     | 1/4                 | -10M0-3TTR            | 67.0       | 33.5 | 17.2 | 5.9            | 13/16  | 3/4     | 35.1 | 20.3 |
| 12                     | 3/8                 | -12M0-3TTR            | 72.0       | 36.1 | 22.8 | 7.9            | 13/16  | 7/8     | 37.1 | 24.4 |
|                        | 1/2                 | -12M0-3-8TTR          | 76.1       | 38.1 |      | 9.5            | 5/16   | 1 1/16  | 43.4 | 29.5 |

① The E dimension is the minimum nominal opening. These fittings may have a larger opening at the pipe/straight thread end.

**Positionable Run, SAE/MS Straight Thread (TST)**

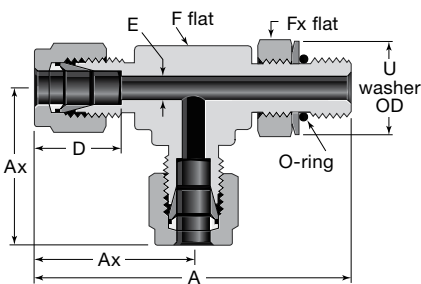

SAE/MS positionable fittings are available in carbon steel and stainless steel only.

Adapts to SAE J1926/1 and ISO 11926-1 straight thread boss.

| Tube OD                | SAE/MS Thread Size | Basic Ordering Number | Dimensions |      |      |                |         |       |      |
|------------------------|--------------------|-----------------------|------------|------|------|----------------|---------|-------|------|
|                        |                    |                       | A          | Ax   | D    | E <sup>①</sup> | F       | Fx    | U    |
| <b>Dimensions, in.</b> |                    |                       |            |      |      |                |         |       |      |
| 1/4                    | 7/16-20            | -400-3TST             | 2.24       | 1.12 | 0.60 | 0.19           | 1/2     | 9/16  | 0.65 |
| 3/8                    | 9/16-18            | -600-3TST             | 2.53       | 1.26 | 0.66 | 0.28           | 5/8     | 11/16 | 0.79 |
| 1/2                    | 3/4-16             | -810-3TST             | 2.97       | 1.48 | 0.90 | 0.41           | 13/16   | 7/8   | 1.01 |
| 3/4                    | 1 1/16-12          | -1210-3TST            | 3.55       | 1.63 | 0.96 | 0.62           | 1 1/16  | 1 1/4 | 1.44 |
| 1                      | 1 5/16-12          | -1610-3TST            | 4.10       | 1.99 | 1.23 | 0.88           | 1 3/8   | 1 1/2 | 1.73 |
| 1 1/4                  | 1 5/8-12           | -2000-3TST            | 4.96       | 2.67 | 1.62 | 1.09           | 1 11/16 | 1 7/8 | 2.16 |
| 1 1/2                  | 1 7/8-12           | -2400-3TST            | 5.45       | 3.07 | 1.97 | 1.34           | 2       | 2 1/8 | 2.45 |
| 2                      | 2 1/2-12           | -3200-3TST            | 7.04       | 4.22 | 2.66 | 1.81           | 2 3/4   | 2 3/4 | 3.16 |

① The E dimension is the minimum nominal opening. These fittings may have a larger opening at the pipe/straight thread end.

**Tees**

**Male**

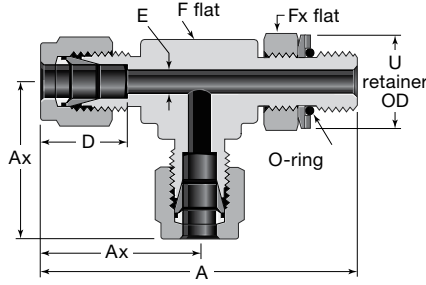

See page 8 for thread specifications.

**Positionable Run, ISO/BSP Parallel Thread (TRT)**

| Tube OD                | ISO Thread Size in. | Basic Ordering Number    | Dimensions   |              |      |                |            |             |              |
|------------------------|---------------------|--------------------------|--------------|--------------|------|----------------|------------|-------------|--------------|
|                        |                     |                          | A            | Ax           | D    | E <sup>①</sup> | F, in.     | Fx, in.     | U            |
| <b>Dimensions, in.</b> |                     |                          |              |              |      |                |            |             |              |
| 1/4                    | 1/8<br>1/4          | -400-3TRT<br>-400-3-4TRT | 2.10<br>2.41 | 1.06<br>1.14 | 0.60 | 0.16<br>0.19   | 1/2<br>5/8 | 9/16<br>3/4 | 0.60<br>0.80 |
| 3/8                    | 1/4                 | -600-3TRT                | 2.47         | 1.20         | 0.66 | 0.23           | 5/8        | 3/4         | 0.80         |
| 1/2                    | 3/8                 | -810-3TRT                | 2.88         | 1.42         | 0.90 | 0.31           | 13/16      | 7/8         | 0.96         |
|                        | 1/2                 | -810-3-8TRT              | 3.21         | 1.50         |      | 0.41           | 15/16      | 1 1/16      | 1.16         |
| 5/8                    | 1/2                 | -1010-3TRT               | 3.21         | 1.50         | 0.96 | 0.47           | 15/16      | 1 1/16      | 1.16         |
| 3/4                    | 3/4                 | -1210-3TRT               | 3.49         | 1.57         | 0.96 | 0.62           | 1 1/16     | 1 3/8       | 1.43         |
|                        | 1/2                 | -1210-3-8TRT             | 3.35         |              |      | 0.47           |            | 1 1/16      | 1.16         |
| 1                      | 1                   | -1610-3TRT               | 4.04         | 1.93         | 1.23 | 0.78           | 1 3/8      | 1 5/8       | 1.82         |
| <b>Dimensions, mm</b>  |                     |                          |              |              |      |                |            |             |              |
| 6                      | 1/8                 | -6M0-3TRT                | 53.4         | 27.0         | 15.3 | 4.0            | 1/2        | 9/16        | 15.2         |
|                        | 1/4                 | -6M0-3-4TRT              | 61.2         | 29.0         |      | 4.8            | 5/8        | 3/4         | 20.3         |
| 8                      | 1/8                 | -8M0-3TRT                | 56.3         | 28.8         | 16.2 | 4.0            | 9/16       | 9/16        | 15.2         |
|                        | 1/4                 | -8M0-3-4TRT              | 62.1         | 29.9         |      | 6.4            | 5/8        | 3/4         | 20.3         |
| 10                     | 1/4                 | -10M0-3TRT               | 68.6         | 33.5         | 17.2 | 5.9            | 13/16      | 3/4         | 20.3         |
| 12                     | 3/8                 | -12M0-3TRT               | 73.1         | 36.0         | 22.8 | 7.9            | 13/16      | 7/8         | 24.4         |
|                        | 1/2                 | -12M0-3-8TRT             | 81.5         | 38.0         |      | 9.5            | 15/16      | 1 1/16      | 29.5         |

① The E dimension is the minimum nominal opening. These fittings may have a larger opening at the pipe/straight thread end.

**Female**

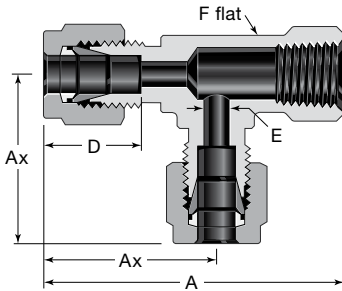

Tube ports are identical.

**Run, NPT (TFT)**

| Tube OD                | NPT Size in. | Basic Ordering Number | Dimensions |      |      |      |         |
|------------------------|--------------|-----------------------|------------|------|------|------|---------|
|                        |              |                       | A          | Ax   | D    | E    | F, in.  |
| <b>Dimensions, in.</b> |              |                       |            |      |      |      |         |
| 1/8                    | 1/8          | -200-3TFT             | 1.72       | 0.97 | 0.50 | 0.09 | 1/2     |
| 1/4                    | 1/8          | -400-3TFT             | 1.81       | 1.06 | 0.60 | 0.19 | 1/2     |
|                        | 1/4          | -400-3-4TFT           | 2.05       | 1.17 |      |      | 11/16   |
| 3/8                    | 1/4          | -600-3TFT             | 2.11       | 1.23 | 0.66 | 0.28 | 11/16   |
| 1/2                    | 3/8          | -810-3TFT             | 2.30       | 1.42 | 0.90 | 0.41 | 13/16   |
|                        | 1/2          | -810-3-8TFT           | 2.69       | 1.57 |      |      | 1 1/16  |
| 3/4                    | 3/4          | -1210-3TFT            | 3.01       | 1.76 | 0.96 | 0.62 | 1 3/8   |
| 1                      | 3/4          | -1610-3-12TFT         | 3.18       | 1.93 | 1.23 | 0.88 | 1 3/8   |
|                        | 1            | -1610-3TFT            | 3.61       | 2.11 |      |      | 1 11/16 |
| <b>Dimensions, mm</b>  |              |                       |            |      |      |      |         |
| 6                      | 1/8          | -6M0-3TFT             | 46.0       | 27.0 | 15.3 | 4.8  | 1/2     |
|                        | 1/4          | -6M0-3-4TFT           | 52.1       | 29.8 |      |      | 11/16   |
| 8                      | 1/8          | -8M0-3TFT             | 48.9       | 29.9 | 16.2 | 6.4  | 5/8     |
|                        | 1/4          | -8M0-3-4TFT           | 53.0       | 30.6 |      |      | 11/16   |
| 10                     | 1/4          | -10M0-3TFT            | 55.9       | 33.5 | 17.2 | 7.9  | 13/16   |
| 12                     | 1/4          | -12M0-3-4TFT          | 58.4       | 36.0 | 22.8 | 9.5  | 13/16   |
|                        | 3/8          | -12M0-3TFT            | 58.4       | 36.0 |      | 10.3 | 13/16   |
|                        | 1/2          | -12M0-3-8TFT          | 68.3       | 39.8 |      | 9.5  | 1 1/16  |
| 16                     | 1/2          | -16M0-3TFT            | 68.2       | 39.8 | 24.4 | 12.7 | 1 1/16  |

**Tees**

**Female**

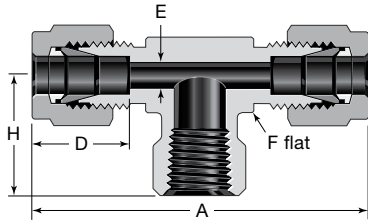

**Branch, NPT (TTF)**

| Tube OD                | NPT Size in. | Basic Ordering Number | Dimensions |      |      |         |      |
|------------------------|--------------|-----------------------|------------|------|------|---------|------|
|                        |              |                       | A          | D    | E    | F, in.  | H    |
| <b>Dimensions, in.</b> |              |                       |            |      |      |         |      |
| 1/8                    | 1/8          | -200-3TTF             | 1.94       | 0.50 | 0.09 | 1/2     | 0.75 |
| 1/4                    | 1/8          | -400-3TTF             | 2.12       | 0.60 | 0.19 | 1/2     | 0.75 |
|                        | 1/4          | -400-3-4TTF           | 2.34       |      |      | 11/16   | 0.88 |
| 3/8                    | 1/4          | -600-3TTF             | 2.46       | 0.66 | 0.28 | 11/16   | 0.88 |
|                        | 3/8          | -600-3-6TTF           | 2.62       |      |      | 13/16   | 0.88 |
|                        | 1/2          | -600-3-8TTF           | 2.84       |      |      | 1       | 1.12 |
| 1/2                    | 1/4          | -810-3-4TTF           | 2.84       | 0.90 | 0.41 | 13/16   | 0.88 |
|                        | 3/8          | -810-3TTF             | 2.84       |      |      | 13/16   | 0.88 |
|                        | 1/2          | -810-3-8TTF           | 3.06       |      |      | 1       | 1.12 |
| 5/8                    | 1/2          | -1010-3TTF            | 3.06       | 0.96 | 0.50 | 1       | 1.12 |
| 3/4                    | 3/4          | -1210-3TTF            | 3.52       | 0.96 | 0.62 | 1 3/8   | 1.25 |
| 1                      | 3/4          | -1610-3-12TTF         | 3.86       | 1.23 | 0.88 | 1 3/8   | 1.25 |
|                        | 1            | -1610-3TTF            | 4.22       |      |      | 1 11/16 | 1.50 |
| <b>Dimensions, mm</b>  |              |                       |            |      |      |         |      |
| 6                      | 1/8          | -6M0-3TTF             | 53.9       | 15.3 | 4.8  | 1/2     | 19.0 |
|                        | 1/4          | -6M0-3-4TTF           | 59.5       |      |      | 11/16   | 22.4 |
| 8                      | 1/8          | -8M0-3TTF             | 59.7       | 16.2 | 6.4  | 5/8     | 19.0 |
|                        | 1/4          | -8M0-3-4TTF           | 61.2       |      |      | 11/16   | 22.4 |
| 10                     | 1/4          | -10M0-3TTF            | 67.0       | 17.2 | 7.9  | 13/16   | 22.4 |
| 12                     | 1/4          | -12M0-3-4TTF          | 72.0       | 22.8 | 9.5  | 13/16   | 22.4 |
|                        | 3/8          | -12M0-3TTF            | 72.0       |      |      | 13/16   | 22.4 |
|                        | 1/2          | -12M0-3-8TTF          | 77.7       |      |      | 1       | 28.4 |
| 16                     | 1/2          | -16M0-3TTF            | 77.6       | 24.4 | 12.7 | 1       | 28.4 |

**Cross**

**Union**

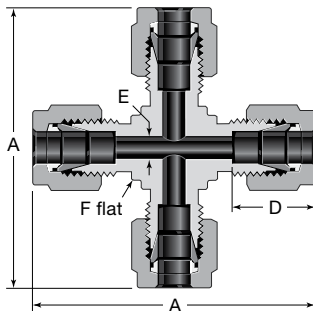

| Tube OD                | Basic Ordering Number | Dimensions |      |      |        |
|------------------------|-----------------------|------------|------|------|--------|
|                        |                       | A          | D    | E    | F, in. |
| <b>Dimensions, in.</b> |                       |            |      |      |        |
| 1/8                    | -200-4                | 1.76       | 0.50 | 0.09 | 3/8    |
| 1/4                    | -400-4                | 2.12       | 0.60 | 0.19 | 1/2    |
| 5/16                   | -500-4                | 2.34       | 0.64 | 0.25 | 5/8    |
| 3/8                    | -600-4                | 2.40       | 0.66 | 0.28 | 5/8    |
| 1/2                    | -810-4                | 2.84       | 0.90 | 0.41 | 13/16  |
| 3/4                    | -1210-4               | 3.14       | 0.96 | 0.62 | 1 1/16 |
| 1                      | -1610-4               | 3.86       | 1.23 | 0.88 | 1 3/8  |
| <b>Dimensions, mm</b>  |                       |            |      |      |        |
| 3                      | -3M0-4                | 44.7       | 12.9 | 2.4  | 3/8    |
| 6                      | -6M0-4                | 53.9       | 15.3 | 4.8  | 1/2    |
| 8                      | -8M0-4                | 59.7       | 16.2 | 6.4  | 5/8    |
| 10                     | -10M0-4               | 67.0       | 17.2 | 7.9  | 13/16  |
| 12                     | -12M0-4               | 72.0       | 22.8 | 9.5  | 13/16  |
| 16                     | -16M0-4               | 74.0       | 24.4 | 12.7 | 15/16  |
| 18                     | -18M0-4               | 76.6       | 24.4 | 15.1 | 1 1/16 |
| 20                     | -20M0-4               | 89.3       | 26.0 | 15.9 | 1 3/8  |
| 22                     | -22M0-4               | 89.4       | 26.0 | 18.3 | 5/8    |
| 25                     | -25M0-4               | 98.3       | 31.3 | 21.8 | 1 3/8  |



## Sanitary Flange Fittings

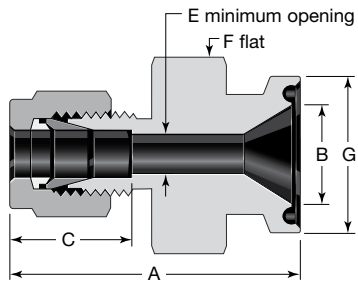

### Kwik-Clamp Flange To Swagelok Tube Fitting

| Tube OD<br>in. | Flange Size<br>in. | Ordering Number | Dimensions, in. (mm) |             |             |             |       |             |
|----------------|--------------------|-----------------|----------------------|-------------|-------------|-------------|-------|-------------|
|                |                    |                 | A                    | B           | C           | E           | F     | G           |
| 1/4            | 1/2                | SS-400-SC-8     | 1.57 (39.9)          | 0.37 (9.4)  | 0.60 (15.2) | 0.19 (4.8)  | 1     | 0.98 (24.9) |
|                | 3/4                | SS-400-SC-12    |                      | 0.62 (15.7) |             |             |       |             |
|                | 1                  | SS-400-SC-16    |                      | 0.87 (22.1) |             |             | 1 3/8 |             |
|                | 1 1/2              | SS-400-SC-24    |                      | 1.37 (34.8) |             |             |       |             |
| 3/8            | 1/2                | SS-600-SC-8     | 1.63 (41.4)          | 0.37 (9.4)  | 0.66 (16.8) | 0.28 (7.1)  | 1     | 0.98 (24.9) |
|                | 3/4                | SS-600-SC-12    |                      | 0.62 (15.7) |             |             |       |             |
|                | 1                  | SS-600-SC-16    |                      | 0.87 (22.1) |             |             | 1 3/8 |             |
|                | 1 1/2              | SS-600-SC-24    |                      | 1.37 (34.8) |             |             |       |             |
| 1/2            | 1/2                | SS-810-SC-8     | 1.74 (44.2)          | 0.37 (9.4)  | 0.90 (22.9) | 0.37 (9.4)  | 1     | 0.98 (24.9) |
|                | 3/4                | SS-810-SC-12    |                      | 0.62 (15.7) |             | 0.41 (10.4) |       |             |
|                | 1                  | SS-810-SC-16    |                      | 0.87 (22.1) |             |             | 1 3/8 |             |
|                | 1 1/2              | SS-810-SC-24    |                      | 1.37 (34.8) |             |             |       |             |
| 1              | 1                  | SS-1610-SC-16   | 1.91 (48.5)          | 0.87 (22.1) | 1.23 (31.2) | 0.87 (22.1) | 1 3/8 | 1.98 (50.3) |
|                | 2                  | SS-1610-SC-32   | 2.49 (63.2)          | 1.37 (34.8) |             | 0.88 (22.4) | 2 3/4 | 2.52 (64.0) |

## Tube Adapters

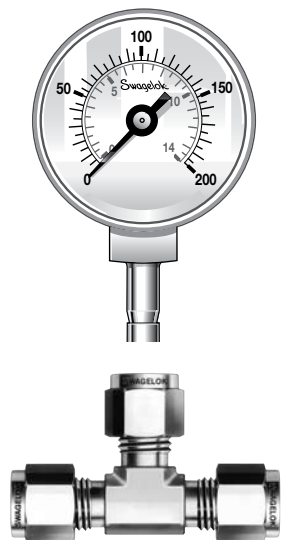

### Solve Alignment Problems and Reduce Inventories

Swagelok tube adapters can help eliminate difficult alignment problems and reduce inventories. Swagelok tube adapters can be used with any Swagelok tube fittings in this catalog. So, stocking union elbows and union tees in various sizes and materials—along with commonly used Swagelok adapters—eliminates the need for stocking special elbows and tees.

#### Typical Alignment Problem

When installing pipe elbows or tees, it is often difficult to align the fitting with the desired run.

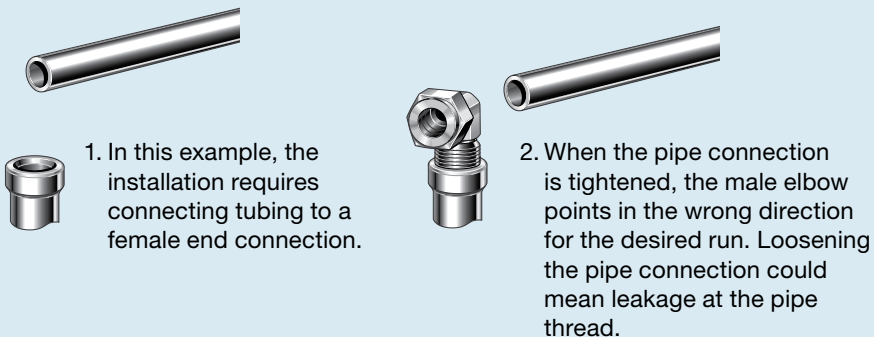

#### Swagelok Solution

By using a Swagelok tube adapter in conjunction with a union elbow or tee, these difficulties can be avoided.

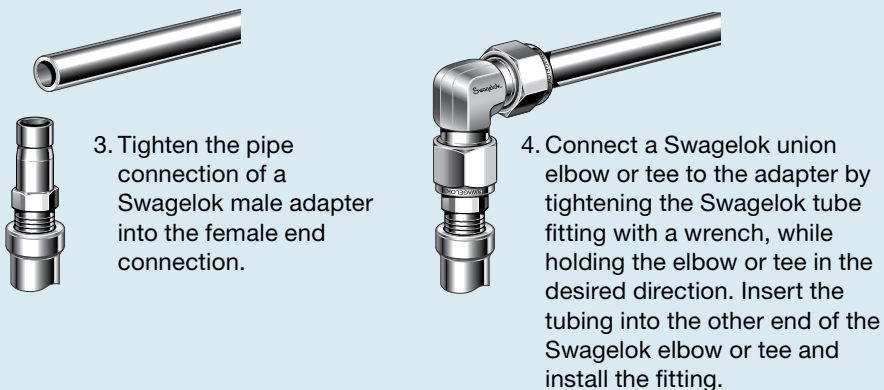

**⚠ Swagelok tube adapters are to be used ONLY in Swagelok tube fittings. Use in fittings made by other manufacturers may result in leakage or slippage.**

## Tube Adapters

### Male

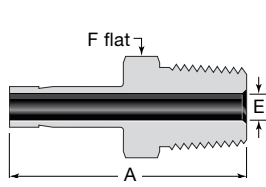

1 in./25 mm and under

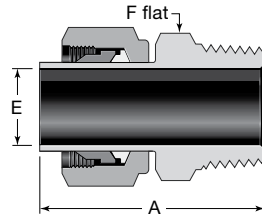

Over 1 in./25 mm

### NPT

| Tube OD                | NPT Size in. | Basic Ordering Number     | Dimensions |                |        |
|------------------------|--------------|---------------------------|------------|----------------|--------|
|                        |              |                           | A          | E <sup>①</sup> | F      |
| <b>Dimensions, in.</b> |              |                           |            |                |        |
| 1/8                    | 1/8          | -2-TA-1-2                 | 1.16       | 0.08           | 7/16   |
|                        | 1/4          | -2-TA-1-4                 | 1.37       |                | 9/16   |
| 3/16                   | 1/8          | -3-TA-1-2                 | 1.19       | 0.12           | 7/16   |
|                        | 1/4          | -3-TA-1-4                 | 1.40       |                | 9/16   |
| 1/4                    | 1/8          | -4-TA-1-2                 | 1.25       | 0.17           | 7/16   |
|                        | 1/4          | -4-TA-1-4                 | 1.46       |                | 9/16   |
|                        | 3/8          | -4-TA-1-6                 | 1.49       |                | 11/16  |
|                        | 1/2          | -4-TA-1-8                 | 1.71       |                | 7/8    |
| 5/16                   | 1/8          | -5-TA-1-2                 | 1.29       | 0.19           | 7/16   |
|                        | 1/4          | -5-TA-1-4                 | 1.50       |                | 9/16   |
| 3/8                    | 1/8          | -6-TA-1-2                 | 1.32       | 0.19           | 7/16   |
|                        | 1/4          | -6-TA-1-4                 | 1.53       |                | 9/16   |
|                        | 3/8          | -6-TA-1-6                 | 1.56       |                | 11/16  |
|                        | 1/2          | -6-TA-1-8                 | 1.78       |                | 7/8    |
| 1/2                    | 1/4          | -8-TA-1-4                 | 1.75       | 0.28           | 9/16   |
|                        | 3/8          | -8-TA-1-6                 | 1.78       |                | 11/16  |
|                        | 1/2          | -8-TA-1-8                 | 2.00       |                | 7/8    |
| 5/8                    | 1/2          | -10-TA-1-8                | 2.06       | 0.47           | 7/8    |
|                        | 3/4          | -12-TA-1-8                | 2.06       |                | 7/8    |
| 3/4                    | 1/2          | -12-TA-1-8                | 2.06       | 0.58           | 1 1/16 |
|                        | 3/4          | -12-TA-1-12               | 2.06       |                | 1 1/16 |
| 1                      | 3/4          | -16-TA-1-12               | 2.31       | 0.62           | 1 1/16 |
|                        | 1            | -16-TA-1-16               | 2.60       |                | 1 3/8  |
| 1 1/4                  | 1 1/4        | -20-TA-1-20 <sup>②</sup>  | 3.16       | 1.02           | 1 3/4  |
| 1 1/2                  | 1 1/2        | -24-TA-1-24 <sup>②</sup>  | 3.72       | 1.25           | 2 1/8  |
| 2                      | 2            | -32-TA-1-32 <sup>②</sup>  | 4.70       | 1.72           | 2 3/4  |
| <b>Dimensions, mm</b>  |              |                           |            |                |        |
| 6                      | 1/8          | -6-MTA-1-2                | 32.8       | 4.1            | 12     |
|                        | 1/4          | -6-MTA-1-4                | 38.1       |                | 14     |
| 8                      | 1/4          | -8-MTA-1-4                | 39.1       | 5.6            | 14     |
|                        | 3/8          | -8-MTA-1-6                | 39.9       |                | 19     |
| 10                     | 1/4          | -10-MTA-1-4               | 39.9       | 7.1            | 14     |
|                        | 3/8          | -10-MTA-1-6               | 40.6       |                | 18     |
|                        | 1/2          | -10-MTA-1-8               | 46.2       |                | 22     |
| 12                     | 1/4          | -12-MTA-1-4               | 46.5       | 7.1            | 16     |
|                        | 1/2          | -12-MTA-1-8               | 52.1       |                | 8.8    |
| 28                     | 1            | -28-MTA-1-16 <sup>②</sup> | 74.7       | 22.2           | 35     |
|                        | 1 1/4        | -28-MTA-1-20 <sup>②</sup> | 76.2       |                | 22.5   |
| 30                     | 1            | -30-MTA-1-16 <sup>②</sup> | 79.2       | 22.2           | 41     |
|                        | 1 1/4        | -30-MTA-1-20 <sup>②</sup> | 80.0       |                | 24.3   |
| 32                     | 1 1/4        | -32-MTA-1-20 <sup>②</sup> | 81.0       | 26.5           | 46     |
| 38                     | 1 1/2        | -38-MTA-1-24 <sup>②</sup> | 92.2       | 31.6           | 55     |

① The E dimension is the minimum nominal opening. These fittings may have a larger opening at the pipe/straight thread end.

② Furnished with nut and preswaged ferrules.

### ISO/BSP Tapered Thread (RT)

| Tube OD                | ISO Thread Size in. | Basic Ordering Number       | Dimensions |                |        |    |
|------------------------|---------------------|-----------------------------|------------|----------------|--------|----|
|                        |                     |                             | A          | E <sup>①</sup> | F      |    |
| <b>Dimensions, in.</b> |                     |                             |            |                |        |    |
| 1/8                    | 1/8                 | -2-TA-1-2RT                 | 1.16       | 0.08           | 7/16   |    |
|                        | 1/4                 | -2-TA-1-4RT                 | 1.37       |                | 9/16   |    |
| 1/4                    | 1/8                 | -4-TA-1-2RT                 | 1.25       | 0.17           | 7/16   |    |
|                        | 1/4                 | -4-TA-1-4RT                 | 1.46       |                | 9/16   |    |
| 3/8                    | 1/4                 | -6-TA-1-4RT                 | 1.53       | 0.27           | 9/16   |    |
|                        | 3/8                 | -6-TA-1-6RT                 | 1.56       |                | 11/16  |    |
|                        | 1/2                 | -6-TA-1-8RT                 | 1.78       |                | 7/8    |    |
| 1/2                    | 1/4                 | -8-TA-1-4RT                 | 1.75       | 0.28           | 9/16   |    |
|                        | 3/8                 | -8-TA-1-6RT                 | 1.78       |                | 11/16  |    |
|                        | 1/2                 | -8-TA-1-8RT                 | 2.00       |                | 7/8    |    |
| 3/4                    | 3/4                 | -12-TA-1-12RT               | 2.06       | 0.58           | 1 1/16 |    |
| 1                      | 1                   | -16-TA-1-16RT               | 2.60       | 0.80           | 1 3/8  |    |
| <b>Dimensions, mm</b>  |                     |                             |            |                |        |    |
| 6                      | 1/8                 | -6-MTA-1-2RT                | 32.8       | 4.1            | 12     |    |
|                        | 1/4                 | -6-MTA-1-4RT                | 38.1       |                | 14     |    |
| 8                      | 1/4                 | -8-MTA-1-4RT                | 39.1       | 5.6            | 14     |    |
| 10                     | 1/4                 | -10-MTA-1-4RT               | 39.9       | 7.1            | 14     |    |
|                        | 3/8                 | -10-MTA-1-6RT               | 40.6       |                | 18     |    |
| 12                     | 1/4                 | -12-MTA-1-4RT               | 46.5       | 7.1            | 16     |    |
|                        | 3/8                 | -12-MTA-1-6RT               | 46.2       |                | 8.8    | 18 |
|                        | 1/2                 | -12-MTA-1-8RT               | 51.8       |                | 8.8    | 22 |
| 28                     | 1                   | -28-MTA-1-16RT <sup>②</sup> | 74.7       | 22.2           | 35     |    |
|                        | 1 1/4               | -28-MTA-1-20RT <sup>②</sup> | 76.2       |                | 22.5   | 46 |
| 30                     | 1 1/4               | -30-MTA-1-20RT <sup>②</sup> | 80.0       | 24.3           | 46     |    |
| 32                     | 1 1/4               | -32-MTA-1-20RT <sup>②</sup> | 81.0       | 26.5           | 46     |    |
| 38                     | 1 1/2               | -38-MTA-1-24RT <sup>②</sup> | 92.2       | 31.6           | 55     |    |

① The E dimension is the minimum nominal opening. These fittings may have a larger opening at the pipe/straight thread end.

② Furnished with nut and preswaged ferrules.

## Tube Adapters

### Male

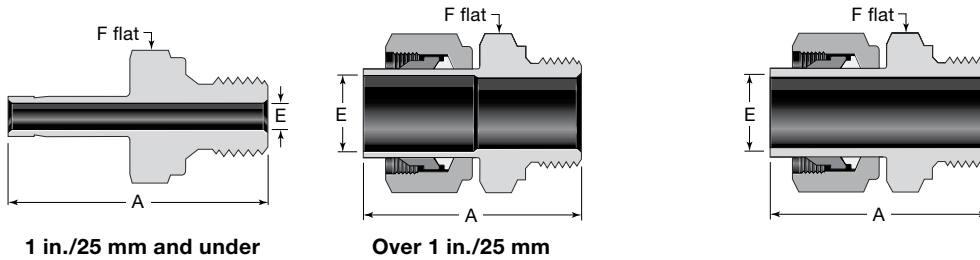

1 in./25 mm and under

Over 1 in./25 mm

ISO/BSP parallel gaskets are available. See page 53.

ISO/BSP parallel gaskets are available. See page 53.

### ISO/BSP Parallel Thread (RS)

| Tube OD                | ISO Thread Size in. | Basic Ordering Number       | Dimensions |                |        |
|------------------------|---------------------|-----------------------------|------------|----------------|--------|
|                        |                     |                             | A          | E <sup>①</sup> | F      |
| <b>Dimensions, in.</b> |                     |                             |            |                |        |
| 1/8                    | 1/8                 | -2-TA-1-2RS                 | 1.25       | 0.08           | 9/16   |
|                        | 1/4                 | -2-TA-1-4RS                 | 1.43       |                | 3/4    |
| 1/4                    | 1/8                 | -4-TA-1-2RS                 | 1.35       | 0.16           | 9/16   |
|                        | 1/4                 | -4-TA-1-4RS                 | 1.53       | 0.17           | 3/4    |
| 3/8                    | 1/4                 | -6-TA-1-4RS                 | 1.59       | 0.23           | 3/4    |
|                        | 3/8                 | -6-TA-1-6RS                 | 1.62       | 0.27           | 7/8    |
| 1/2                    | 1/4                 | -8-TA-1-4RS                 | 1.85       | 0.23           | 3/4    |
|                        | 3/8                 | -8-TA-1-6RS                 | 1.88       | 0.31           | 7/8    |
|                        | 1/2                 | -8-TA-1-8RS                 | 1.96       | 0.37           | 1 1/16 |
| 3/4                    | 3/4                 | -12-TA-1-12RS               | 2.20       | 0.58           | 1 5/16 |
| 1                      | 1                   | -16-TA-1-16RS               | 2.59       | 0.80           | 1 5/8  |
| <b>Dimensions, mm</b>  |                     |                             |            |                |        |
| 6                      | 1/8                 | -6-MTA-1-2RS                | 34.3       | 4.0            | 14     |
|                        | 1/4                 | -6-MTA-1-4RS                | 38.9       | 4.1            | 19     |
| 8                      | 1/4                 | -8-MTA-1-4RS                | 39.6       | 5.6            | 19     |
| 10                     | 1/4                 | -10-MTA-1-4RS               | 40.4       | 5.9            | 19     |
|                        | 3/8                 | -10-MTA-1-6RS               | 41.1       | 7.1            | 22     |
|                        | 1/2                 | -10-MTA-1-8RS               | 43.2       | 7.1            | 27     |
| 12                     | 1/4                 | -12-MTA-1-4RS               | 47.0       | 5.9            | 19     |
|                        | 3/8                 | -12-MTA-1-6RS               | 47.8       | 7.9            | 22     |
|                        | 1/2                 | -12-MTA-1-8RS               | 49.8       | 8.8            | 27     |
| 18                     | 1/2                 | -18-MTA-1-8RS               | 51.3       | 11.9           | 27     |
|                        | 3/4                 | -18-MTA-1-12RS              | 55.9       | 13.9           | 35     |
| 28                     | 1                   | -28-MTA-1-16RS <sup>②</sup> | 71.9       | 19.8           | 41     |
|                        | 1 1/4               | -28-MTA-1-20RS <sup>②</sup> | 75.4       | 22.5           | 50     |
| 30                     | 1 1/4               | -30-MTA-1-20RS <sup>②</sup> | 79.8       | 24.3           | 50     |
| 32                     | 1 1/4               | -32-MTA-1-20RS <sup>②</sup> | 80.8       | 26.5           | 50     |
| 38                     | 1 1/2               | -38-MTA-1-24RS <sup>②</sup> | 91.9       | 31.6           | 55     |

① The E dimension is the minimum nominal opening. These fittings may have a larger opening at the pipe/straight thread end.

② Furnished with nut and preswaged ferrules.

### ISO/BSP Parallel Thread (RP)

| Tube OD               | ISO Thread Size in. | Basic Ordering Number       | Dimensions |                |    |
|-----------------------|---------------------|-----------------------------|------------|----------------|----|
|                       |                     |                             | A          | E <sup>①</sup> | F  |
| <b>Dimensions, mm</b> |                     |                             |            |                |    |
| 28                    | 1                   | -28-MTA-1-16RP <sup>②</sup> | 72.7       | 19.8           | 41 |
|                       | 1 1/4               | -28-MTA-1-20RP <sup>②</sup> | 77.3       | 22.5           | 50 |
| 30                    | 1 1/4               | -30-MTA-1-20RP <sup>②</sup> | 81.1       | 24.3           | 50 |
| 32                    | 1 1/4               | -32-MTA-1-20RP <sup>②</sup> | 82.1       | 26.5           | 50 |
| 38                    | 1 1/2               | -38-MTA-1-24RP <sup>②</sup> | 94.5       | 31.8           | 55 |

① The E dimension is the minimum nominal opening. These fittings may have a larger opening at the pipe/straight thread end.

② Furnished with nut and preswaged ferrules.

## Tube Adapters

### Male

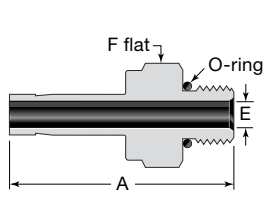

1 in./25 mm and under

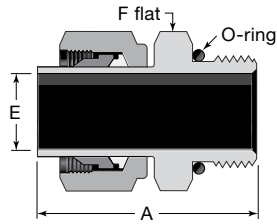

Over 1 in./25 mm

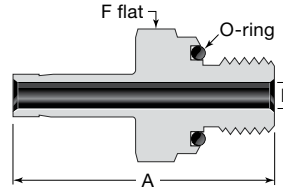

See page 18 for mounting dimensions.

Adapts to SAE J1926/1 and ISO 11926-1 straight thread boss.

### SAE/MS Straight Thread (ST)

| Tube OD         | SAE/MS Thread Size | Basic Ordering Number      | Dimensions |                |       |
|-----------------|--------------------|----------------------------|------------|----------------|-------|
|                 |                    |                            | A          | E <sup>①</sup> | F     |
| Dimensions, in. |                    |                            |            |                |       |
| 1/8             | 5/16-24            | -2-TA-1-2ST                | 1.20       | 0.08           | 7/16  |
| 1/4             | 7/16-20            | -4-TA-1-4ST                | 1.39       | 0.17           | 9/16  |
| 3/8             | 7/16-20            | -6-TA-1-4ST                | 1.46       | 0.20           | 9/16  |
|                 | 9/16-18            | -6-TA-1-6ST                | 1.52       | 0.27           | 11/16 |
| 3/4-16          | 3/4-16             | -6-TA-1-8ST                | 1.60       | 0.27           | 7/8   |
|                 | 9/16-18            | -8-TA-1-6ST                | 1.74       | 0.28           | 11/16 |
| 1/2             | 3/4-16             | -8-TA-1-8ST                | 1.82       | 0.37           | 7/8   |
|                 | 7/8-14             | -10-TA-1-10ST              | 1.94       | 0.47           | 1     |
| 3/4             | 1 1/16-12          | -12-TA-1-12ST              | 2.10       | 0.58           | 1 1/4 |
| 1               | 1 5/16-12          | -16-TA-1-16ST              | 2.41       | 0.80           | 1 1/2 |
| 1 1/4           | 1 5/8-12           | -20-TA-1-20ST <sup>②</sup> | 2.81       | 1.02           | 1 7/8 |
| 1 1/2           | 1 7/8-12           | -24-TA-1-24ST <sup>②</sup> | 3.28       | 1.25           | 2 1/8 |
| 2               | 2 1/2-12           | -32-TA-1-32ST <sup>②</sup> | 4.23       | 1.72           | 2 3/4 |

① The E dimension is the minimum nominal opening. These fittings may have a larger opening at the pipe/straight thread end.

② Furnished with nut and preswaged ferrules.

### O-Seal (SAE/MS Straight Thread)

| Tube OD         | SAE/MS Thread Size | Basic Ordering Number | Dimensions |      |       |
|-----------------|--------------------|-----------------------|------------|------|-------|
|                 |                    |                       | A          | E    | F     |
| Dimensions, in. |                    |                       |            |      |       |
| 1/8             | 5/16-24            | -2-TA-1-OR            | 1.28       | 0.08 | 9/16  |
| 3/16            | 3/8-24             | -3-TA-1-OR            | 1.38       | 0.12 | 5/8   |
| 1/4             | 7/16-20            | -4-TA-1-OR            | 1.54       | 0.17 | 3/4   |
| 5/16            | 1/2-20             | -5-TA-1-OR            | 1.64       | 0.22 | 7/8   |
| 3/8             | 9/16-18            | -6-TA-1-OR            | 1.70       | 0.27 | 15/16 |
| 1/2             | 3/4-16             | -8-TA-1-OR            | 1.95       | 0.37 | 1 1/8 |

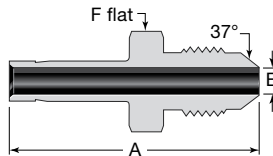

### AN Thread

| Tube OD         | AN Tube Flare Size | Thread Size    | Basic Ordering Number | Dimensions |                |       |
|-----------------|--------------------|----------------|-----------------------|------------|----------------|-------|
|                 |                    |                |                       | A          | E <sup>①</sup> | F     |
| Dimensions, in. |                    |                |                       |            |                |       |
| 1/4             | 1/4                | 7/16-20UNJF-3  | -4-TA-1-4AN           | 1.46       | 0.17           | 1/2   |
| 3/8             | 1/4                | 7/16-20UNJF-3  | -6-TA-1-4AN           | 1.53       | 0.17           | 1/2   |
|                 | 3/8                | 9/16-18UNJF-3  | -6-TA-1-6AN           | 1.56       | 0.27           | 5/8   |
| 1/2             | 1/2                | 3/4-16UNJF-3   | -8-TA-1-8AN           | 1.91       | 0.37           | 13/16 |
| 3/4             | 3/4                | 1 1/16-12UNJ-3 | -12-TA-1-12AN         | 2.21       | 0.58           | 1 1/8 |
| 1               | 1                  | 1 5/16-12UNJ-3 | -16-TA-1-16AN         | 2.58       | 0.80           | 1 3/8 |

① The E dimension is the minimum nominal opening. These fittings may have a larger opening at the pipe/straight thread end.

## Tube Adapters

### Male

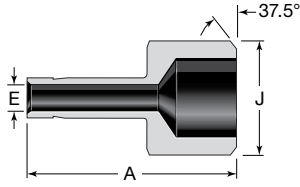

### Pipe Weld

| Tube OD         | Pipe Weld Size | Basic Ordering Number | Dimensions |      |       |
|-----------------|----------------|-----------------------|------------|------|-------|
|                 |                |                       | A          | E    | J     |
| Dimensions, in. |                |                       |            |      |       |
| 1/4             | 1/4            | -4-TA-1-4W            | 1.14       | 0.17 | 0.540 |
| 3/8             | 1/2            | -6-TA-1-8W            | 1.46       | 0.27 | 0.840 |
| 1/2             | 1/2            | -8-TA-1-8W            | 1.66       | 0.37 | 0.840 |
|                 | 3/4            | -8-TA-1-12W           | 1.68       |      |       |
| 3/4             | 3/4            | -12-TA-1-12W          | 1.87       | 0.58 | 1.050 |

Wall thickness at weld end is based on schedule 80 pipe.

### Female

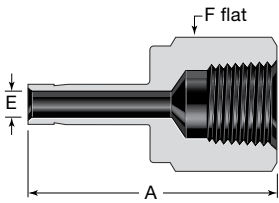

1 in./25 mm and under

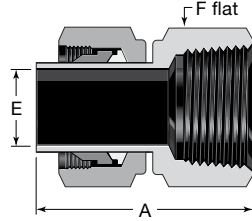

Over 1 in./25 mm

### NPT

| Tube OD         | NPT Size in. | Basic Ordering Number    | Dimensions |      |        |
|-----------------|--------------|--------------------------|------------|------|--------|
|                 |              |                          | A          | E    | F      |
| Dimensions, in. |              |                          |            |      |        |
| 1/8             | 1/8          | -2-TA-7-2                | 1.24       | 0.08 | 9/16   |
|                 | 1/4          | -2-TA-7-4                | 1.39       |      | 3/4    |
| 3/16            | 1/4          | -3-TA-7-4                | 1.41       | 0.12 | 3/4    |
| 1/4             | 1/8          | -4-TA-7-2                | 1.30       | 0.17 | 9/16   |
|                 | 1/4          | -4-TA-7-4                | 1.46       |      | 3/4    |
|                 | 3/8          | -4-TA-7-6                | 1.55       |      | 7/8    |
|                 | 1/2          | -4-TA-7-8                | 1.79       |      | 1 1/16 |
| 5/16            | 1/4          | -5-TA-7-4                | 1.48       | 0.22 | 3/4    |
| 3/8             | 1/8          | -6-TA-7-2                | 1.35       | 0.27 | 9/16   |
|                 | 1/4          | -6-TA-7-4                | 1.50       |      | 3/4    |
|                 | 3/8          | -6-TA-7-6                | 1.59       |      | 7/8    |
|                 | 1/2          | -6-TA-7-8                | 1.84       |      | 1 1/16 |
| 1/2             | 1/4          | -8-TA-7-4                | 1.71       | 0.37 | 3/4    |
|                 | 3/8          | -8-TA-7-6                | 1.79       |      | 7/8    |
|                 | 1/2          | -8-TA-7-8                | 2.05       |      | 1 1/16 |
| 5/8             | 1/2          | -10-TA-7-8               | 2.09       | 0.47 | 1 1/16 |
| 3/4             | 1/2          | -12-TA-7-8               | 2.08       | 0.58 | 1 1/16 |
|                 | 3/4          | -12-TA-7-12              | 2.16       |      | 1 5/16 |
|                 | 1            | -12-TA-7-16              | 2.30       |      | 1 5/8  |
| 1               | 3/4          | -16-TA-7-12              | 2.39       | 0.80 | 1 5/16 |
|                 | 1            | -16-TA-7-16              | 2.53       |      | 1 5/8  |
| 1 1/4           | 1 1/4        | -20-TA-7-20 <sup>①</sup> | 3.06       | 1.02 | 2 1/8  |
| 1 1/2           | 1 1/2        | -24-TA-7-24 <sup>①</sup> | 3.50       | 1.25 | 2 3/8  |
|                 | 2            | -32-TA-7-32 <sup>①</sup> | 4.23       |      | 2 7/8  |
| Dimensions, mm  |              |                          |            |      |        |
| 6               | 1/8          | -6-MTA-7-2               | 32.5       | 4.1  | 14     |
|                 | 1/4          | -6-MTA-7-4               | 37.1       |      | 19     |
| 8               | 1/4          | -8-MTA-7-4               | 37.6       | 5.6  | 19     |
| 10              | 1/4          | -10-MTA-7-4              | 38.1       | 7.1  | 19     |
|                 | 3/8          | -10-MTA-7-6              | 40.1       |      | 22     |
|                 | 1/2          | -10-MTA-7-8              | 46.7       |      | 27     |
| 12              | 1/4          | -12-MTA-7-4              | 43.7       | 8.8  | 19     |
|                 | 1/2          | -12-MTA-7-8              | 52.3       |      | 27     |

① Furnished with nut and preswaged ferrules.

### ISO/BSP Tapered Thread (RT)

| Tube OD         | ISO Thread Size in. | Basic Ordering Number | Dimensions |      |        |
|-----------------|---------------------|-----------------------|------------|------|--------|
|                 |                     |                       | A          | E    | F      |
| Dimensions, in. |                     |                       |            |      |        |
| 1/4             | 1/8                 | -4-TA-7-2RT           | 1.30       | 0.17 | 9/16   |
|                 | 1/4                 | -4-TA-7-4RT           | 1.45       |      | 3/4    |
| 3/8             | 1/4                 | -6-TA-7-4RT           | 1.50       | 0.27 | 3/4    |
|                 | 3/8                 | -6-TA-7-6RT           | 1.59       |      | 7/8    |
| 1/2             | 1/4                 | -8-TA-7-4RT           | 1.71       | 0.37 | 3/4    |
|                 | 3/8                 | -8-TA-7-6RT           | 1.80       |      | 7/8    |
|                 | 1/2                 | -8-TA-7-8RT           | 2.05       |      | 1 1/16 |
| Dimensions, mm  |                     |                       |            |      |        |
| 6               | 1/8                 | -6-MTA-7-2RT          | 33.0       | 4.1  | 14     |
| 8               | 1/4                 | -8-MTA-7-4RT          | 37.6       | 5.6  | 19     |
| 10              | 1/4                 | -10-MTA-7-4RT         | 38.1       | 7.1  | 19     |

## Tube Adapters

### Female

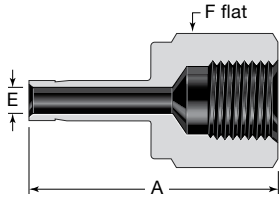

ISO/BSP parallel gaskets and O-rings are available. See page 53.

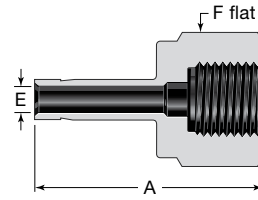

ISO/BSP parallel gaskets and O-rings are available. See page 53.

#### ISO/BSP Parallel Thread (RP)

| Tube OD         | ISO Thread Size in. | Basic Ordering Number | Dimensions |      |        |
|-----------------|---------------------|-----------------------|------------|------|--------|
|                 |                     |                       | A          | E    | F      |
| Dimensions, in. |                     |                       |            |      |        |
| 1/8             | 1/8                 | -2-TA-7-2RP           | 1.17       | 0.08 | 9/16   |
| 1/4             | 1/8                 | -4-TA-7-2RP           | 1.25       | 0.17 | 9/16   |
|                 | 1/4                 | -4-TA-7-4RP           | 1.50       |      | 3/4    |
| 3/8             | 1/4                 | -6-TA-7-4RP           | 1.55       | 0.27 | 3/4    |
|                 | 3/8                 | -6-TA-7-6RP           | 1.57       |      | 15/16  |
| 1/2             | 3/8                 | -8-TA-7-6RP           | 1.78       | 0.38 | 15/16  |
|                 | 1/2                 | -8-TA-7-8RP           | 2.02       |      | 1 1/16 |
| Dimensions, mm  |                     |                       |            |      |        |
| 6               | 1/8                 | -6-MTA-7-2RP          | 32.0       | 4.1  | 14     |
|                 | 1/4                 | -6-MTA-7-4RP          | 37.8       |      | 19     |
| 12              | 1/2                 | -12-MTA-7-8RP         | 49.8       | 8.8  | 27     |

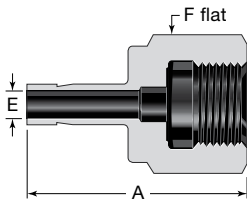

ISO/BSP parallel thread (RJ) fittings are available in stainless steel only. ISO/BSP parallel gaskets and O-rings are available. See page 53.

#### ISO/BSP Parallel Thread (RG, Gauge)

| Tube OD         | ISO Thread Size in. | Basic Ordering Number | Dimensions |      |        |
|-----------------|---------------------|-----------------------|------------|------|--------|
|                 |                     |                       | A          | E    | F      |
| Dimensions, in. |                     |                       |            |      |        |
| 1/4             | 1/4                 | -4-TA-7-4RG           | 1.39       | 0.17 | 3/4    |
| 3/8             | 3/8                 | -6-TA-7-6RG           | 1.55       | 0.26 | 15/16  |
| 1/2             | 1/2                 | -8-TA-7-8RG           | 1.80       | 0.28 | 1 1/16 |
| Dimensions, mm  |                     |                       |            |      |        |
| 6               | 1/4                 | -6-MTA-7-4RG          | 35.3       | 4.1  | 19     |
|                 | 3/8                 | -6-MTA-7-6RG          | 38.4       |      | 24     |
|                 | 1/2                 | -6-MTA-7-8RG          | 42.9       |      | 27     |
| 8               | 1/4                 | -8-MTA-7-4RG          | 33.0       | 5.6  | 19     |
|                 | 3/8                 | -8-MTA-7-6RG          | 38.9       |      | 24     |
|                 | 1/2                 | -8-MTA-7-8RG          | 43.7       |      | 27     |
| 10              | 1/4                 | -10-MTA-7-4RG         | 34.5       | 7.1  | 19     |
|                 | 3/8                 | -10-MTA-7-6RG         | 36.1       |      | 24     |
|                 | 1/2                 | -10-MTA-7-8RG         | 41.1       |      | 27     |
| 12              | 1/4                 | -12-MTA-7-4RG         | 40.1       | 7.0  | 19     |
|                 | 3/8                 | -12-MTA-7-6RG         | 44.7       |      | 24     |
|                 | 1/2                 | -12-MTA-7-8RG         | 48.8       |      | 27     |
| 16              | 1/2                 | -16-MTA-7-8RG         | 49.0       | 7.0  | 27     |
| 18              | 1/2                 | -18-MTA-7-8RG         | 49.3       | 7.0  | 27     |

#### ISO/BSP Parallel Thread (RJ)

| Tube OD         | ISO Thread Size in. | Ordering Number | Dimensions |      |        |
|-----------------|---------------------|-----------------|------------|------|--------|
|                 |                     |                 | A          | E    | F      |
| Dimensions, in. |                     |                 |            |      |        |
| 1/4             | 1/4                 | SS-4-TA-7-4RJ   | 1.39       | 0.17 | 3/4    |
| 3/8             | 3/8                 | SS-6-TA-7-6RJ   | 1.55       | 0.26 | 15/16  |
| 1/2             | 1/2                 | SS-8-TA-7-8RJ   | 1.94       | 0.28 | 1 1/16 |
| Dimensions, mm  |                     |                 |            |      |        |
| 6               | 1/4                 | SS-6-MTA-7-4RJ  | 35.3       | 4.1  | 19     |
|                 | 3/8                 | SS-6-MTA-7-6RJ  | 38.6       |      | 24     |
|                 | 1/2                 | SS-6-MTA-7-8RJ  | 42.9       |      | 27     |
| 8               | 1/4                 | SS-8-MTA-7-4RJ  | 33.0       | 5.6  | 19     |
|                 | 3/8                 | SS-8-MTA-7-6RJ  | 39.4       |      | 24     |
|                 | 1/2                 | SS-8-MTA-7-8RJ  | 43.7       |      | 27     |
| 10              | 1/4                 | SS-10-MTA-7-4RJ | 34.5       | 7.1  | 19     |
|                 | 3/8                 | SS-10-MTA-7-6RJ | 36.1       |      | 24     |
|                 | 1/2                 | SS-10-MTA-7-8RJ | 41.1       |      | 27     |
| 12              | 1/4                 | SS-12-MTA-7-4RJ | 40.1       | 7.0  | 19     |
|                 | 3/8                 | SS-12-MTA-7-6RJ | 44.7       |      | 24     |
|                 | 1/2                 | SS-12-MTA-7-8RJ | 48.8       |      | 27     |

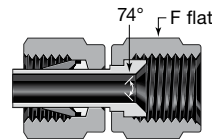

#### AN Thread

| Tube OD         | AN Tube Flare Size | Basic Ordering Number | F     |
|-----------------|--------------------|-----------------------|-------|
| Dimensions, in. |                    |                       |       |
| 1/8             | 1/8                | -200-A-2ANF           | 3/8   |
|                 | 1/4                | -200-A-4ANF           | 9/16  |
| 1/4             | 1/4                | -400-A-4ANF           | 9/16  |
| 3/8             | 3/8                | -600-A-6ANF           | 11/16 |
| 1/2             | 1/2                | -810-A-8ANF           | 7/8   |
| 3/4             | 3/4                | -1210-A-12ANF         | 1 1/4 |

## Additional Ordering Information

Swagelok tube fitting ordering numbers follow the sequence shown below.

**A** - **B C D** - **E** - **F G**  
**SS** - **2 0 0** - **1** - **2 RT**

### A Material

- A = Aluminum
- B = Brass
- C20 = Alloy 20
- HC = Alloy C-276
- INC = Alloy 600
- M = Alloy 400
- NY = Nylon
- S = Carbon steel
- SS = 316 stainless steel
- T = PTFE
- TI = Titanium
- 625 = Alloy 625
- 825 = Alloy 825

### B Size (Tube OD)

| Fractional, in. | Metric, mm |
|-----------------|------------|
| 1 = 1/16        | 2 = 2      |
| 2 = 1/8         | 3 = 3      |
| 3 = 3/16        | 4 = 4      |
| 4 = 1/4         | 6 = 6      |
| 5 = 5/16        | 8 = 8      |
| 6 = 3/8         | 10 = 10    |
| 8 = 1/2         | 12 = 12    |
| 10 = 5/8        | 14 = 14    |
| 12 = 3/4        | 15 = 15    |
| 14 = 7/8        | 16 = 16    |
| 16 = 1          | 18 = 18    |
| 18 = 1 1/8      | 20 = 20    |
| 20 = 1 1/4      | 22 = 22    |
| 24 = 1 1/2      | 25 = 25    |
| 32 = 2          | 28 = 28    |
|                 | 32 = 32    |
|                 | 38 = 38    |
|                 | 50 = 50    |

### C Series

- 0 = Fractional 1/16 to 3/8 in. and 1 1/4 to 2 in.
- 1 = Fractional 1/2 to 1 1/8 in.
- M = Millimeter tube size

To order a female Swagelok tube fitting, add F.  
 Example: SS-100F-1-1.

### D Component

- 0 = Fitting
- 1 = Body

### E Fitting Type

- 1 = Male connector
- 2 = 90° male elbow
- 3 = Tee, union
- 4 = Cross, union
- 5 = 45° male elbow
- 6 = Union
- 7 = Female connector
- 8 = Female elbow
- 9 = Elbow, union
- 11 = Bulkhead male connector
- 61 = Bulkhead union
- 71 = Bulkhead female connector
- A = Adapter
- C = Cap
- P = Plug
- PC = Port connector
- R = Reducer
- R1 = Bulkhead reducer
- 2R = Reducing elbow
- TFT = Tee, female run
- TMT = Tee, male run
- TRT = Tee, ISO/BSP parallel male positionable run
- TST = Tee, straight thread with O-ring male positionable run
- TTF = Tee, female branch
- TTM = Tee, male branch
- TTR = Tee, ISO/BSP parallel male positionable branch
- TTS = Tee, straight thread with O-ring male positionable branch

### F Second End Connection Size

Add a size designator from the list at left for the second end connection or if the fitting is a reducing union.

### G Second End Connection Type

Add a second end connection type designator as needed.

- AN = 37° male AN flare
- ANF = 37° female AN flare
- BT = Bored-through fitting
- F = Female thread
- KN = Knurled nut, nylon ferrules
- KT = Knurled nut, PTFE ferrules
- M = Metric tube end
- OR = O-seal connection
- PR = ISO/BSP positionable parallel pipe thread
- RG = ISO/BSP parallel pipe thread (gauge)
- RJ = ISO/BSP parallel pipe thread (Japanese gauge)
- RP = ISO/BSP parallel pipe thread
- RS = ISO/BSP parallel pipe thread
- RT = ISO/BSP tapered pipe thread
- ST = Straight thread with O-ring (for SAE/MS)
- W = Male pipe weld/tube socket weld

## Tees and Crosses

Ordering numbers for tees and crosses indicate first the size of the run (1 to 2) and then the size of the branch (3 for tees and 3 to 4 for crosses).

Example: SS-6M0-3-4TTF for a 316 SS female tee for 6 mm tube with 1/4 in. female NPT branch

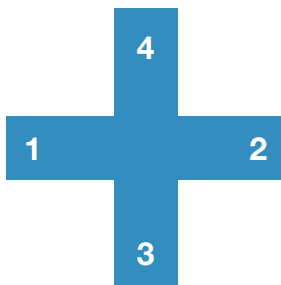

## Additional Sizes and Materials

Contact your authorized Swagelok representative for information about additional sizes and special alloys.



## Additional Ordering Information

Swagelok tube adapter ordering numbers follow the sequence shown below.

**A** - **B** - **C** - **D** - **E** **F**  
**SS** - **2** - **TA** - **1** - **4** **RT**

### A Material

A = Aluminum

B = Brass

C20 = Alloy 20

HC = Alloy C-276

INC = Alloy 600

M = Alloy 400

NY = Nylon

S = Carbon steel

SS = 316 stainless steel

T = PTFE

TI = Titanium

625 = Alloy 625

825 = Alloy 825

### B Size (Tube OD)

| Fractional, in. | Metric, mm |
|-----------------|------------|
| 1 = 1/16        | 2 = 2      |
| 2 = 1/8         | 3 = 3      |
| 3 = 3/16        | 4 = 4      |
| 4 = 1/4         | 6 = 6      |
| 5 = 5/16        | 8 = 8      |
| 6 = 3/8         | 10 = 10    |
| 8 = 1/2         | 12 = 12    |
| 10 = 5/8        | 14 = 14    |
| 12 = 3/4        | 15 = 15    |
| 14 = 7/8        | 16 = 16    |
| 16 = 1          | 18 = 18    |
| 18 = 1 1/8      | 20 = 20    |
| 20 = 1 1/4      | 22 = 22    |
| 24 = 1 1/2      | 25 = 25    |
| 32 = 2          | 28 = 28    |
|                 | 32 = 32    |
|                 | 38 = 38    |
|                 | 50 = 50    |

### C Component

TA = Fractional tube adapter

MTA = Metric tube adapter

### D Adapter Type

1 = Male adapter

7 = Female adapter

### E Second End Connection Size

Add a size designator from the list at left for the second end connection.

### F Second End Connection Type

Add a second end connection type designator as needed.

AN = 37° male AN flare

ANF = 37° female AN flare

RG = ISO/BSP parallel pipe thread (gauge)

RJ = ISO/BSP parallel pipe thread (Japanese gauge)

RP = ISO/BSP parallel pipe thread

RS = ISO/BSP parallel pipe thread

RT = ISO/BSP tapered pipe thread

ST = Straight thread with O-ring (for SAE/MS)

W = Male pipe weld/ tube socket weld

## Replacement Parts

To order, add a material designator from the **How to Order** table on page 10.

### Nuts

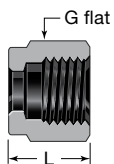

#### Female

| Tube OD                | Basic Ordering Number | Dimensions |      |
|------------------------|-----------------------|------------|------|
|                        |                       | G          | L    |
| <b>Dimensions, in.</b> |                       |            |      |
| 1/16                   | -102-1                | 5/16       | 0.31 |
| 1/8                    | -202-1                | 7/16       | 0.47 |
| 3/16                   | -302-1                | 1/2        | 0.47 |
| 1/4                    | -402-1                | 9/16       | 0.50 |
| 5/16                   | -502-1                | 5/8        | 0.53 |
| 3/8                    | -602-1                | 11/16      | 0.56 |
| 1/2                    | -812-1                | 7/8        | 0.69 |
| 5/8                    | -1012-1               | 1          | 0.69 |
| 3/4                    | -1212-1               | 1 1/8      | 0.69 |
| 7/8                    | -1412-1               | 1 1/4      | 0.69 |
| 1                      | -1612-1               | 1 1/2      | 0.81 |
| 1 1/4                  | -2002-1               | 1 7/8      | 1.25 |
| 1 1/2                  | -2402-1               | 2 1/4      | 1.50 |
| 2                      | -3202-1               | 3          | 2.06 |

| Tube OD               | Basic Ordering Number | Dimensions |      |
|-----------------------|-----------------------|------------|------|
|                       |                       | G          | L    |
| <b>Dimensions, mm</b> |                       |            |      |
| 2                     | -2M2-1                | 12         | 11.9 |
| 3                     | -3M2-1                | 12         | 11.9 |
| 4                     | -4M2-1                | 12         | 11.9 |
| 6                     | -6M2-1                | 14         | 12.7 |
| 8                     | -8M2-1                | 16         | 13.5 |
| 10                    | -10M2-1               | 19         | 15.1 |
| 12                    | -12M2-1               | 22         | 17.4 |
| 14                    | -14M2-1               | 25         | 17.4 |
| 15                    | -15M2-1               | 25         | 17.4 |
| 16                    | -16M2-1               | 25         | 17.4 |
| 18                    | -18M2-1               | 30         | 17.4 |
| 20                    | -20M2-1               | 32         | 17.4 |
| 22                    | -22M2-1               | 32         | 17.4 |
| 25                    | -25M2-1               | 38         | 20.6 |
| 28                    | -28M2-1               | 46         | 30.6 |
| 30                    | -30M2-1               | 50         | 32.7 |
| 32                    | -32M2-1               | 50         | 34.4 |
| 38                    | -38M2-1               | 50         | 40.6 |
| 50                    | -50M2-1               | 3 in.      | 52.3 |

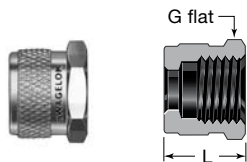

#### Knurled Female

The Swagelok knurled nut tube fitting provides a leak-tight seal without the use of inserts on most wall thicknesses of polyethylene tubing. Inserts may be required for larger sizes.

To set the ferrules on the tubing, initial connections must be made with a wrench, tightening the nut one and one-quarter turns from finger-tight (three-quarter turn for 1/16, 1/8 and 3/16 in.; 2, 3, and 4 mm fittings). Leak-tight connections may be reassembled with finger-tight assembly.

To order a knurled nut, add **K** to the female nut basic ordering number.

Example: B-402-1**K**

To order a knurled nut on an assembled fitting with nylon ferrules, add **KN** to the fitting ordering number.

Example: SS-400-1-2**KN**

To order a knurled nut on an assembled fitting with PTFE ferrules, add **KT** to the fitting ordering number.

Example: SS-400-1-2**KT**

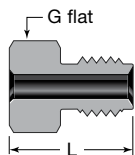

#### Male

| Tube OD                | Basic Ordering Number | Dimensions |      |
|------------------------|-----------------------|------------|------|
|                        |                       | G          | L    |
| <b>Dimensions, in.</b> |                       |            |      |
| 1/16                   | -1F2-1GC              | 1/4        | 0.38 |
| 1/8                    | -2F2-1GC              | 3/8        | 0.53 |
| 1/4                    | -4F2-1                | 1/2        | 0.62 |
| 1/2                    | -8F2-1                | 15/16      | 0.87 |

| Tube OD               | Basic Ordering Number | Dimensions |      |
|-----------------------|-----------------------|------------|------|
|                       |                       | G          | L    |
| <b>Dimensions, mm</b> |                       |            |      |
| 10                    | -10MF2-1              | 22         | 22.1 |
| 12                    | -12MF2-1              | 24         | 22.1 |

For use in female Swagelok end connections.

## Replacement Parts

To order, add a material designator from the **How to Order** table on page 10.

### Ferrules



**Front**

| Tube OD                | Basic Ordering Number |
|------------------------|-----------------------|
| <b>Dimensions, in.</b> |                       |
| 1/16                   | -103-1                |
| 1/8                    | -203-1                |
| 3/16                   | -303-1                |
| 1/4                    | -403-1                |
| 5/16                   | -503-1                |
| 3/8                    | -603-1                |
| 1/2                    | -813-1                |
| 5/8                    | -1013-1               |
| 3/4                    | -1213-1               |
| 7/8                    | -1413-1               |
| 1                      | -1613-1               |
| 1 1/4                  | -2003-1 <sup>①</sup>  |
| 1 1/2                  | -2403-1 <sup>①</sup>  |
| 2                      | -3203-1 <sup>①</sup>  |

<sup>①</sup> Over 1 in. and over 25 mm stainless steel front ferrules are PFA coated. To order silver-plated front ferrules, add **-BL** to the basic ordering number.  
Example: SS-2003-1-**BL**

| Tube OD               | Basic Ordering Number |
|-----------------------|-----------------------|
| <b>Dimensions, mm</b> |                       |
| 2                     | -2M3-1                |
| 3                     | -3M3-1                |
| 4                     | -4M3-1                |
| 6                     | -6M3-1                |
| 8                     | -8M3-1                |
| 10                    | -10M3-1               |
| 12                    | -12M3-1               |
| 14                    | -14M3-1               |
| 15                    | -15M3-1               |
| 16                    | -16M3-1               |
| 18                    | -18M3-1               |
| 20                    | -20M3-1               |
| 22                    | -22M3-1               |
| 25                    | -25M3-1               |
| 28                    | -28M3-1 <sup>①</sup>  |
| 30                    | -30M3-1 <sup>①</sup>  |
| 32                    | -32M3-1 <sup>①</sup>  |
| 38                    | -38M3-1 <sup>①</sup>  |
| 50                    | -50M3-1 <sup>①</sup>  |



**Back**

| Tube OD                | Basic Ordering Number |
|------------------------|-----------------------|
| <b>Dimensions, in.</b> |                       |
| 1/16                   | -104-1                |
| 1/8                    | -204-1                |
| 3/16                   | -304-1                |
| 1/4                    | -404-1                |
| 5/16                   | -504-1                |
| 3/8                    | -604-1                |
| 1/2                    | -814-1                |
| 5/8                    | -1014-1               |
| 3/4                    | -1214-1               |
| 7/8                    | -1414-1               |
| 1                      | -1614-1               |
| 1 1/4                  | -2004-1 <sup>①</sup>  |
| 1 1/2                  | -2404-1 <sup>①</sup>  |
| 2                      | -3204-1 <sup>①</sup>  |

<sup>①</sup> Over 1 in. and over 25 mm stainless steel back ferrules are PFA coated. To order back ferrules without PFA coating, add **-WC** to the basic ordering number.  
Example: SS-2004-1-**WC**

| Tube OD               | Basic Ordering Number |
|-----------------------|-----------------------|
| <b>Dimensions, mm</b> |                       |
| 2                     | -2M4-1                |
| 3                     | -3M4-1                |
| 4                     | -4M4-1                |
| 6                     | -6M4-1                |
| 8                     | -8M4-1                |
| 10                    | -10M4-1               |
| 12                    | -12M4-1               |
| 14                    | -14M4-1               |
| 15                    | -15M4-1               |
| 16                    | -16M4-1               |
| 18                    | -18M4-1               |
| 20                    | -20M4-1               |
| 22                    | -22M4-1               |
| 25                    | -25M4-1               |
| 28                    | -28M4-1 <sup>①</sup>  |
| 30                    | -30M4-1 <sup>①</sup>  |
| 32                    | -32M4-1 <sup>①</sup>  |
| 38                    | -38M4-1 <sup>①</sup>  |
| 50                    | -50M4-1 <sup>①</sup>  |

## Replacement Parts

### Nut-Ferrule Set and Ferrule Set

#### Use of Nuts and Ferrules

Using Swagelok nuts and ferrules on tube fittings or valves with tube end connections requires critical interaction of precision parts.

Swagelok nuts and ferrules are sold as replacement parts for use with only Swagelok bodies, fittings, valves, and hose products.

Sets are shown with arbors. One arbor holds five nut-ferrule sets or ten ferrule sets.

#### Nut-Ferrule Set



The nut-ferrule set contains one nut, one back ferrule, and one front ferrule.

To order, add a material designator to the basic ordering number. Please order nut-ferrule sets in multiples of five.

Example: **SS-400-NFSET**

| Material            | Designator |
|---------------------|------------|
| Brass               | B          |
| Carbon steel        | S          |
| 316 stainless steel | SS         |

| Tube OD                | Basic Ordering Number |
|------------------------|-----------------------|
| <b>Dimensions, in.</b> |                       |
| 1/4                    | -400-NFSET            |
| 3/8                    | -600-NFSET            |
| 1/2                    | -810-NFSET            |
| <b>Dimensions, mm</b>  |                       |
| 6                      | -6M0-NFSET            |
| 8                      | -8M0-NFSET            |
| 10                     | -10M0-NFSET           |
| 12                     | -12M0-NFSET           |

#### Ferrule Set



The ferrule set contains one front ferrule and one back ferrule. To order, add a material designator to the basic ordering number. Please order ferrule sets in multiples of ten.

Example: **SS-100-SET**

| Material            | Designator |
|---------------------|------------|
| Alloy 400           | M          |
| Aluminum            | A          |
| Brass               | B          |
| Carbon steel        | S          |
| Nylon               | NY         |
| PTFE                | T          |
| 316 stainless steel | SS         |

| Tube OD                | Basic Ordering Number |
|------------------------|-----------------------|
| <b>Dimensions, in.</b> |                       |
| 1/16                   | -100-SET              |
| 1/8                    | -200-SET              |
| 3/16                   | -300-SET              |
| 1/4                    | -400-SET              |
| 5/16                   | -500-SET              |
| 3/8                    | -600-SET              |
| 1/2                    | -810-SET              |
| <b>Dimensions, mm</b>  |                       |
| 6                      | -6M0-SET              |
| 8                      | -8M0-SET              |
| 10                     | -10M0-SET             |
| 12                     | -12M0-SET             |

#### Nut-Ferrule Package and Ferrule-Pak Package

To order the nut-ferrule package (50 nut-ferrule sets) or ferrule-pak package (100 front and back sets), contact your authorized Swagelok sales and service representative.

Nut-Ferrule Package



Ferrule-Pak Package

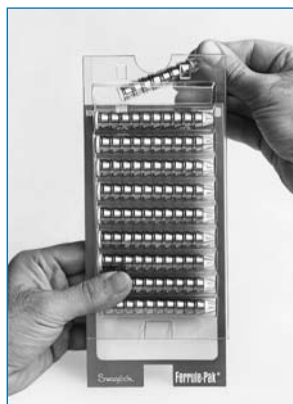

## Replacement Parts

### ISO/BSP Parallel Gaskets

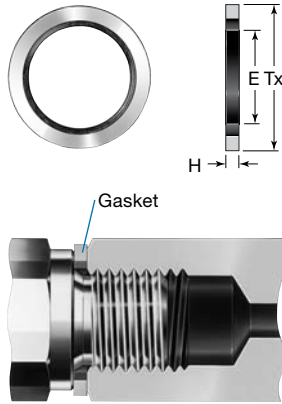

#### Steel (RS Fitting)

The RS fitting steel gasket provides a seal with male ISO/BSP parallel threads. The gasket consists of a fluorocarbon FKM or Buna inner ring bonded to a carbon steel outer ring. To order, add **V** for fluorocarbon FKM or **B** for Buna to the basic ordering number.

Example: S-2-RS-2**B**

For use only with Swagelok RS fittings.

| ISO Thread Size | Basic Ordering Number | Dimensions |      |      |
|-----------------|-----------------------|------------|------|------|
|                 |                       | E          | H    | Tx   |
| Dimensions, in. |                       |            |      |      |
| 1/8             | S-2-RS-2              | 0.41       | 0.08 | 0.63 |
| 1/4             | S-4-RS-2 <sup>①</sup> | 0.54       |      | 0.81 |
| 3/8             | S-6-RS-2 <sup>①</sup> | 0.68       |      | 0.94 |
| 1/2             | S-8-RS-2 <sup>①</sup> | 0.85       | 0.10 | 1.13 |
| 3/4             | S-12-RS-2             | 1.06       |      | 1.38 |
| 1               | S-16-RS-2             | 1.33       |      | 1.69 |

<sup>①</sup> Also available with fluorocarbon FKM inner ring bonded to a stainless steel outer ring. To order, replace **S** with **SS** in the basic ordering number.  
Example: **SS-8-RS-2V**

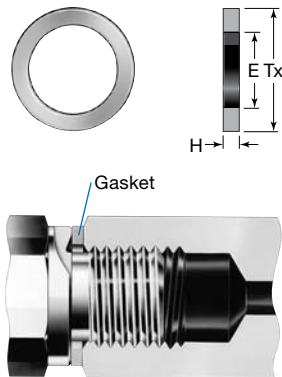

#### Copper (RP Fitting)

The RP fitting copper gasket provides a seal with male ISO/BSP parallel threads. May be used with a Swagelok RS fitting.

| ISO Thread Size | Ordering Number | Dimensions |      |      |
|-----------------|-----------------|------------|------|------|
|                 |                 | E          | H    | Tx   |
| Dimensions, in. |                 |            |      |      |
| 1/8             | CU-2-RP-2       | 0.39       | 0.04 | 0.59 |
| 1/4             | CU-4-RP-2       | 0.52       | 0.06 | 0.75 |
| 3/8             | CU-6-RP-2       | 0.66       |      | 0.91 |
| 1/2             | CU-8-RP-2       | 0.83       |      | 1.06 |
| 3/4             | CU-12-RP-2      | 1.05       | 0.08 | 1.30 |
| 1               | CU-16-RP-2      | 1.31       |      | 1.58 |

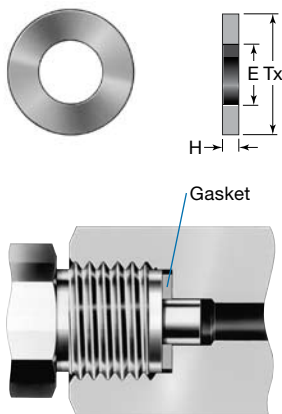

#### Copper (RG, Gauge Fitting)

The RG fitting copper gasket provides a seal on pressure gauges equipped with ISO/BSP parallel male threads.

| ISO Thread Size | Ordering Number | Dimensions |      |      |
|-----------------|-----------------|------------|------|------|
|                 |                 | E          | H    | Tx   |
| Dimensions, in. |                 |            |      |      |
| 1/4             | CU-4-RG-2       | 0.30       | 0.07 | 0.42 |
| 3/8             | CU-6-RG-2       | 0.34       | 0.09 | 0.56 |
| 1/2             | CU-8-RG-2       | 0.36       | 0.10 | 0.70 |

#### PTFE (RJ Fitting)

The RJ fitting PTFE gasket provides a seal with ISO/BSP parallel male threads.

| ISO Thread Size in. | Ordering Number | Dimensions |     |      |
|---------------------|-----------------|------------|-----|------|
|                     |                 | E          | H   | Tx   |
| Dimensions, mm      |                 |            |     |      |
| Regular Gaskets     |                 |            |     |      |
| 1/4                 | T-4-RJ-2        | 5.6        | 1.0 | 10.9 |
| 3/8                 | T-6-RJ-2        |            |     | 13.9 |
| 1/2                 | T-8-RJ-2        |            |     | 17.8 |
| Thick Gaskets       |                 |            |     |      |
| 1/4                 | T-4-RJ-2-T      | 5.6        | 4.1 | 10.9 |
| 3/8                 | T-6-RJ-2-T      |            | 4.6 | 13.9 |
| 1/2                 | T-8-RJ-2-T      |            | 5.1 | 17.8 |

## Replacement Parts

### O-Rings



#### **Buna N (O-Seal Straight Threads)**

O-ring hardness is 70 durometer.

| Thread Size<br>in. | Uniform<br>Size<br>Number | Ordering<br>Number |
|--------------------|---------------------------|--------------------|
| 5/16-24            | 011                       | BN7-OR-0011        |
| 3/8-24             | 012                       | BN7-OR-0012        |
| 7/16-20            | 013                       | BN7-OR-0013        |
| 1/2-20             | 112                       | BN7-OR-0112        |
| 9/16-18            | 113                       | BN7-OR-0113        |
| 3/4-16             | 116                       | BN7-OR-0116        |
| 1 1/16-12          | 121                       | BN7-OR-0121        |
| 1 5/16-12          | 125                       | BN7-OR-0125        |

#### **Buna N (O-Seal Pipe Threads)**

O-ring hardness is 70 durometer.

| NPT/ISO<br>Pipe Size<br>in. | Uniform<br>Size<br>Number | Ordering<br>Number |
|-----------------------------|---------------------------|--------------------|
| 1/8                         | 013                       | BN7-OR-0013        |
| 1/4                         | 113                       | BN7-OR-0113        |
| 3/8                         | 116                       | BN7-OR-0116        |
| 1/2                         | 118                       | BN7-OR-0118        |

#### **Fluorocarbon FKM (Positionable Fittings, ISO/BSP Parallel Threads)**

O-ring hardness is 90 durometer.

| ISO<br>Thread<br>Size<br>in. | Uniform<br>Size<br>Number | Ordering<br>Number |
|------------------------------|---------------------------|--------------------|
| 1/8                          | 502 <sup>①</sup>          | VI9-OR-0502        |
| 1/4                          | 111                       | VI9-OR-0111        |
| 3/8                          | 113                       | VI9-OR-0113        |
| 1/2                          | 508 <sup>①</sup>          | VI9-OR-0508        |
| 3/4                          | 119                       | VI9-OR-0119        |
| 1                            | 217                       | VI9-OR-0217        |

<sup>①</sup> Not a uniform O-ring size.

#### **Fluorocarbon FKM (SAE/MS Straight Threads)**

O-ring hardness is 90 durometer.

| SAE/MS<br>Thread<br>Size<br>in. | Uniform<br>Size<br>Number | Ordering<br>Number |
|---------------------------------|---------------------------|--------------------|
| 5/16-24                         | 902                       | VI9-OR-0902        |
| 3/8-24                          | 903                       | VI9-OR-0903        |
| 7/16-20                         | 904                       | VI9-OR-0904        |
| 1/2-20                          | 905                       | VI9-OR-0905        |
| 9/16-18                         | 906                       | VI9-OR-0906        |
| 3/4-16                          | 908                       | VI9-OR-0908        |
| 7/8-14                          | 910                       | VI9-OR-0910        |
| 1 1/16-12                       | 912                       | VI9-OR-0912        |
| 1 3/16-12                       | 914                       | VI9-OR-0914        |
| 1 5/16-12                       | 916                       | VI9-OR-0916        |
| 1 5/8-12                        | 920                       | VI9-OR-0920        |
| 1 7/8-12                        | 924                       | VI9-OR-0924        |
| 2 1/2-12                        | 932                       | VI9-OR-0932        |

## Tools and Accessories

### Hydraulic Swaging Units

Swagelok hydraulic swaging units preswage Swagelok ferrules onto tubing prior to assembly and provide Swagelok tube fitting connections that are 100 % gaugeable upon initial installation. Multihead hydraulic and air-actuated hydraulic swaging units:

- Place no initial strain on nut or fitting body threads or on body seal surfaces
- Are available with interchangeable fractional and metric tooling
- Fit neatly in a rugged plastic carrying case
- Reduce assembly and installation time and operator error.

#### Multihead Hydraulic Swaging Unit (MHSU)

- Is available in two unit sizes, with tooling for:
  - 1/2 to 1 in. and 12 to 25 mm tubing and tube adapters
  - 1 to 2 in. and 25 to 50 mm tubing and tube adapters
- **Must** be used to install 1 1/4, 1 1/2, and 2 in. and 28, 30, 32, 38, and 50 mm Swagelok tube fittings
- Is standard with a tube marking feature to indicate when tube is properly bottomed in the unit
- Is available with a support base (as shown). See **Ordering Information**, page 56.
- Is available with stainless steel connection tubing in place of hydraulic hose; support base is required. See **Ordering Information**, page 56.

**The MHSU cannot be used for SAF 2507 tubing 1/2 in. and under or for medium-pressure tubing.**

**For 5/8 and 3/4 in. SAF 2507 tubing, order the 1 in./25 mm and over unit and SAF 2507 tooling kit and gap inspection gauges.**



#### MHSU Unit Components

- Multihead hydraulic swaging unit
- Hydraulic hose—2 ft (0.6 m) with all units **except** 1 in./25 mm and over unit without support base, which contains 6 ft (1.8 m) hose
- Retaining ring pliers
- Safety glasses
- Operating instructions
- Carrying case

#### Tooling Kit Components

- Die head sets for Swagelok tube fitting sizes:
  - Fractional, up to 1 in.—1/2, 5/8, 3/4, 7/8, and 1 in.
  - Fractional, 1 in. and over—1, 1 1/4, 1 1/2, and 2 in.
  - Metric, up to 25 mm—12, 14, 15, 16, 18, 20, 22, and 25 mm
  - Metric, 25 mm and over—25, 28, 30, 32, and 38 mm
  - 50 mm tooling available separately
- Gap inspection gauges
- Chamfer block (up to 1 in./25 mm sizes only)

#### Recommended Minimum Wall Thickness of Tubing for use with the MHSU

| Tooling Size    | Steel       | Stainless Steel |
|-----------------|-------------|-----------------|
|                 | Tubing Wall |                 |
| Dimensions, in. |             |                 |
| 1/2             | 0.049       | 0.065           |
| 5/8             | 0.065       |                 |
| 3/4             |             |                 |
| 7/8             |             |                 |
| 1               |             | 0.083           |
| 1 1/4           | 0.083       | 0.095           |
| 1 1/2           | 0.095       | 0.109           |
| 2               |             |                 |

| Tooling Size   | Steel       | Stainless Steel |
|----------------|-------------|-----------------|
|                | Tubing Wall |                 |
| Dimensions, mm |             |                 |
| 12             | 1.5         | 1.5             |
| 14             |             |                 |
| 15             |             | 1.8             |
| 16             |             |                 |
| 18             |             |                 |
| 20             | 2.0         | 2.0             |
| 22             |             |                 |
| 25             |             |                 |
| 28             |             |                 |
| 30             | 2.2         | 2.2             |
| 32             |             |                 |
| 38             |             |                 |
| 50             |             | 2.5             |
|                |             |                 |

**Use of tubing below the recommended minimum wall thickness may result in the tube sticking in the die head.**

#### Technical Data

- Dimensions—MHSU case  
22 in. (55.9 cm) high, 24 in. (61.0 cm) wide, 8.75 in. (22.2 cm) deep
- Weight  
Up to 1 in./25 mm MHSU in case with tooling kit and support base—40 lb (18.1 kg)  
1 in./25 mm and over MHSU in case with tooling kit and support base—55 lb (24.9 kg)
- Construction  
High-strength stainless steel tooling for durability and corrosion resistance

See next page for **Ordering Information**.

## Tools and Accessories

### Hydraulic Swaging Units

#### MHSU Ordering Information

Select an ordering number.

| Ordering Numbers                      |                    |
|---------------------------------------|--------------------|
| MHSU Unit                             |                    |
| Up to 1 in./25 mm sizes               | MS-MHSU-U-E        |
| 1 in./25 mm and over sizes            | MS-MHSU-O-E        |
| MHSU Unit with Tooling Kit            |                    |
| Fractional up to 1 in. sizes          | MS-MHSU-U-E-FKIT-M |
| Fractional 1 in. and over sizes       | MS-MHSU-O-E-FKIT-M |
| Metric up to 25 mm sizes              | MS-MHSU-U-E-MKIT-M |
| Metric 25 to 38 mm <sup>①</sup> sizes | MS-MHSU-O-E-MKIT-M |

① 50 mm tooling available separately.

#### Support Base

Add **-B** to the ordering number.

Examples: MS-MHSU-U-E-**B**  
MS-MHSU-U-E-FKIT-M-**B**

#### Stainless Steel Connection Tubing

Add **-T** to the ordering number for an MHSU with support base.

Examples: MS-MHSU-U-E-**B-T**  
MS-MHSU-U-E-FKIT-M-**B-T**

#### Operating Instructions

MHSU ordering numbers include English-language instructions. For other languages, visit [swagelok.com](http://swagelok.com).

#### Accessories

Additional and replacement gap inspection gauges are available. See page 60.

See the table below for replacement retaining rings and pliers.

| MNSU Unit                  | Ordering Number     |
|----------------------------|---------------------|
| Retaining Ring             |                     |
| Up to 1 in./25 mm sizes    | MS-MHSU-N5000-200-H |
| 1 in./25 mm and over sizes | MS-MHSU-N5000-315-H |
| Retaining Ring Pliers      |                     |
| Up to 1 in./25 mm sizes    | MS-MHSU-0504        |
| 1 in./25 mm and over sizes | MS-MHSU-0700        |

#### Tooling Kits

##### Up to 1 in./25 mm

| Tube OD         | Ordering Number        |
|-----------------|------------------------|
| Dimensions, in. |                        |
| 1/2             | MS-MHSUT-U-810-M       |
| 5/8             | MS-MHSUT-U-1010-M      |
| 3/4             | MS-MHSUT-U-1210-M      |
| 7/8             | MS-MHSUT-U-1410-M      |
| 1               | MS-MHSUT-U-1610-M      |
| SAF 2507 Tubing |                        |
| 5/8             | MS-MHSUT-O-2507-1010-M |
| 3/4             | MS-MHSUT-O-2507-1210-M |
| Dimensions, mm  |                        |
| 12              | MS-MHSUT-U-12M0-M      |
| 14              | MS-MHSUT-U-14M0-M      |
| 15              | MS-MHSUT-U-15M0-M      |
| 16              | MS-MHSUT-U-16M0-M      |
| 18              | MS-MHSUT-U-18M0-M      |
| 20              | MS-MHSUT-U-20M0-M      |
| 22              | MS-MHSUT-U-22M0-M      |
| 25              | MS-MHSUT-U-25M0-M      |

##### 1 in./25 mm and Over

| Tube OD         | Ordering Number   |
|-----------------|-------------------|
| Dimensions, in. |                   |
| 1               | MS-MHSUT-O-1610-M |
| 1 1/4           | MS-MHSUT-O-2000-M |
| 1 1/2           | MS-MHSUT-O-2400-M |
| 2               | MS-MHSUT-O-3200-M |
| Dimensions, mm  |                   |
| 25              | MS-MHSUT-O-25M0-M |
| 28              | MS-MHSUT-O-28M0-M |
| 30              | MS-MHSUT-O-30M0-M |
| 32              | MS-MHSUT-O-32M0-M |
| 38              | MS-MHSUT-O-38M0-M |
| 50              | MS-MHSUT-O-50M0-M |

See the Swagelok *Multihead Hydraulic Swaging Unit (MHSU) Setup and Operating Instructions*, MS-12-37, for information about using the MHSU.

#### Air-Actuated Hydraulic Swaging Unit (AHSU)



- Requires only one unit with interchangeable tooling to swage 1/4 to 1/2 in. and 6 to 12 mm Swagelok tube fitting ferrule sizes
- Requires no threading of nut on or off the tooling

**The AHSU cannot be used for SAF 2507 tubing or for medium-pressure tubing.**

#### AHSU Unit Components

- Air-actuated hydraulic swaging unit
- Hex key
- Adapter plates—for tube fittings smaller than 1/2 in. or 12 mm
- Safety glasses
- Gap inspection gauges
- Operating instructions
- Carrying case

#### Tooling Kit Components

- Die head sets and gap inspection gauges for Swagelok tube fitting sizes:
  - Fractional—1/4, 3/8, and 1/2 in.
  - Metric—6, 8, 10, and 12 mm

#### Technical Data

- Dimensions—AHSU case  
19 in. (48.3 cm) high, 15.5 in. (39.4 cm) wide, 7.5 in. (19.0 cm) deep
- Weight  
AHSU in case with tooling kit—28 lb (12.7 kg)
- Power requirements  
20 to 70 psig (1.3 to 4.9 bar) regulated shop air, depending on fitting size and material
- Construction  
High-strength stainless steel tooling for durability and corrosion resistance
- Air inlet port  
1/4 in. Swagelok tube fitting



## Tools and Accessories

### Hydraulic Swaging Units

#### AHSU Ordering Information

Select an ordering number.

| Ordering Numbers           |                |
|----------------------------|----------------|
| AHSU Unit                  |                |
| AHSU only                  | MS-AHSU-E      |
| AHSU Unit with Tooling Kit |                |
| 1/4, 3/8, 1/2 in. sizes    | MS-AHSU-E-FKIT |
| 6, 8, 10, 12 mm sizes      | MS-AHSU-E-MKIT |

#### Tooling Kits

| Tube OD         | Ordering Number |
|-----------------|-----------------|
| Dimensions, in. |                 |
| 1/4             | MS-AHSUT-400-1  |
| 3/8             | MS-AHSUT-600-1  |
| 1/2             | MS-AHSUT-810-1  |
| Dimensions, mm  |                 |
| 6               | MS-AHSUT-6M0-1  |
| 8               | MS-AHSUT-8M0-1  |
| 10              | MS-AHSUT-10M0-1 |
| 12              | MS-AHSUT-12M0-1 |

#### Operating Instructions

AHSU ordering numbers include English-language instructions. For other languages, visit [swagelok.com](http://swagelok.com).

#### Accessories

Additional and replacement gap inspection gauges are available. See page 60.

See the Swagelok *Air-Actuated Hydraulic Swaging Unit (AHSU) Setup and Operating Instructions*, MS-12-38, for information about using the AHSU.

### Preswaging Tools

For Swagelok tube fitting installations in close quarters, the Swagelok preswaging tool is a convenient accessory.



#### Features

- Preswages ferrules onto the tube
- Enables the installer to work in a more open, safe area
- Makes it possible to complete the installation by following retightening instructions for Swagelok tube fittings.

| Tube OD               | Ordering Number |
|-----------------------|-----------------|
| Dimensions, in.       |                 |
| Female Nut            |                 |
| 1/16                  | MS-ST-100       |
| 1/8                   | MS-ST-200       |
| 3/16                  | MS-ST-300       |
| 1/4                   | MS-ST-400       |
| 5/16                  | MS-ST-500       |
| 3/8                   | MS-ST-600       |
| 1/2                   | MS-ST-810       |
| 5/8 <sup>①</sup>      | MS-ST-1010      |
| 5/8 (SAF 2507)        | MS-ST-2507-1010 |
| 3/4 <sup>①</sup>      | MS-ST-1210      |
| 3/4 (SAF 2507)        | MS-ST-2507-1210 |
| 7/8                   | MS-ST-1410      |
| 1                     | MS-ST-1610      |
| Male Nut              |                 |
| 1/16                  | MS-ST-1F0       |
| 1/4 (medium-pressure) | MS-ST-4FK0      |
| 3/8 (medium-pressure) | MS-ST-6FK0      |
| 1/2 <sup>②</sup>      | MS-ST-8F0       |
| 1/2 (medium-pressure) | MS-ST-8FK0      |

<sup>①</sup> For SAF 2507 tubing, use the preswaging tool for the appropriate tube OD and with **2507** in the ordering number.

<sup>②</sup> For medium-pressure tubing, use the preswaging tool for the appropriate tube OD and with **FK0** in the ordering number.

| Tube OD        | Ordering Number |
|----------------|-----------------|
| Dimensions, mm |                 |
| Female Nut     |                 |
| 3              | MS-ST-3M0       |
| 4              | MS-ST-4M0       |
| 6              | MS-ST-6M0       |
| 8              | MS-ST-8M0       |
| 10             | MS-ST-10M0      |
| 12             | MS-ST-12M0      |
| 14             | MS-ST-14M0      |
| 15             | MS-ST-15M0      |
| 16             | MS-ST-16M0      |
| 18             | MS-ST-18M0      |
| 20             | MS-ST-20M0      |
| 22             | MS-ST-22M0      |
| 25             | MS-ST-25M0      |

## Tools and Accessories

### Wrenches

#### Tee Wrench

The tee wrench provides positive backup support when installing Swagelok union tees and crosses.



#### Features

- Allows user to hold fitting body firmly and precisely
- Is available in a variety of sizes
- Fits and carries easily in tool box, pouch, or belt
- Head and handle constructed of stainless steel
- Features a cushioned vinyl grip and generous gripping area for handle
- Holds tee in various orientations

#### Ordering Information

| For Swagelok Gaugeable Union Tees and Crosses |                 |     |       |
|---|-----------------|-----|-------|
| Tube OD                                       | Ordering Number | Tee | Cross |
| 1/4 in. and 6 mm                              | MS-TW-4         | ✓   | ✓     |
| 5/16 and 3/8 in. and 8 mm                     | MS-TW-6         | ✓   | ✓     |
| 10 mm   | MS-TW-10M       | ✓   | ①     |
| 1/2 in. and 12 mm                             | MS-TW-8         | ✓   | ✓     |

① Use **MS-TW-8** on 10 mm Swagelok crosses.

#### Ratchet Wrench

The ratchet wrench is designed for use on Swagelok nuts for fitting installation.



#### Features

- 11 fractional and metric sizes are available.
- 1/12 turn ratchet facilitates use in close quarters.
- Heavy-duty construction includes:
  - heat-treated, black oxide-plated steel handle
  - black-oxide plated steel jaws
  - stainless steel spring and fasteners.

#### Ordering Information

| Tube OD                | Ordering Number | Wrench Length |
|------------------------|-----------------|---------------|
| <b>Dimensions, in.</b> |                 |               |
| 1/8                    | MS-RW-200       | 5.38          |
| 3/16                   | MS-RW-300       |               |
| 1/4                    | MS-RW-400       | 7.25          |
| 5/16                   | MS-RW-500       |               |
| 3/8                    | MS-RW-600       |               |
| 1/2                    | MS-RW-810       | 10.1          |
| <b>Dimensions, mm</b>  |                 |               |
| 3                      | MS-RW-3M0       | 136           |
| 6                      | MS-RW-6M0       | 184           |
| 8                      | MS-RW-8M0       |               |
| 10                     | MS-RW-10M0      |               |
| 12                     | MS-RW-12M0      | 257           |

#### Ratchet Wrench Pouch

A heavy-duty pouch is available for holding up to six Swagelok ratchet wrenches.

Ordering Number: **MS-RWP**

## Tools and Accessories

### Wrenches

#### Open-End Wrenches

##### Features

- Swagelok open-end wrenches are available in body and nut styles.
- These wrenches are designed to install Swagelok tube fittings (1 1/4, 1 1/2, and 2 in.; 32, 38, and 50 mm sizes) after assembly using the Swagelok multihead hydraulic swaging unit (MHSU), page 55.
- The body wrench is box ended and can be used with shapes or hex bodies.
- The nut wrench has a multiple internal hex to allow easy fixturing of the nut when space is limited.
- The hole in the wrench head enables wrenches to be secured by a lanyard for installations in elevated areas.
- The telescoping feature of the knurled handle provides additional leverage when needed.

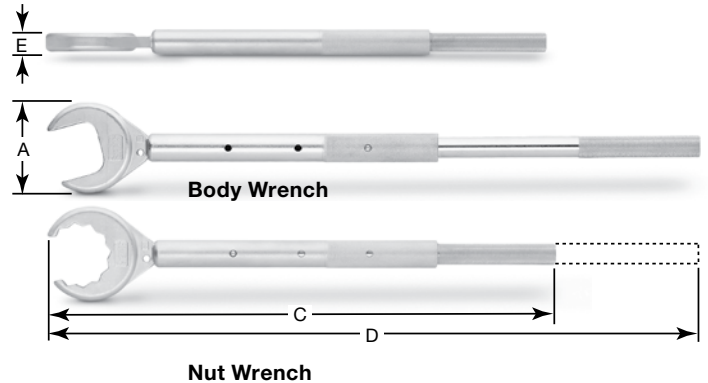

#### Ordering Information and Dimensions

Dimensions are for reference only and are subject to change.

##### Nut Wrench

| Tube OD         | Ordering Number | Dimensions |      |      |      | Weight |
|-----------------|-----------------|------------|------|------|------|--------|
|                 |                 | A          | C    | D    | E    |        |
| Dimensions, in. |                 |            |      |      |      | lb     |
| 1 1/4           | MS-NW-20(1.88)  | 3.16       | 18.0 | 22.8 | 0.73 | 3      |
| 1 1/2           | MS-NW-24(2.25)  | 3.88       | 26.1 | 33.2 | 0.99 | 6      |
| 2               | MS-NW-32(3.00)  | 5.06       | 32.5 | 42.0 | 1.25 | 11     |
| Dimensions, cm  |                 |            |      |      |      | kg     |
| 32              | MS-NW-32M(50M)  | 8.53       | 46.2 | 58.4 | 1.85 | 1.4    |
| 38              | MS-NW-38M(60M)  | 10.1       | 66.6 | 84.6 | 2.51 | 3.2    |
| 50              | MS-NW-32(3.00)  | 12.9       | 82.6 | 107  | 3.18 | 5.0    |

##### Body Wrench

| Tube OD         | Flat Size | Ordering Number | Dimensions |      |      |      | Weight |
|-----------------|-----------|-----------------|------------|------|------|------|--------|
|                 |           |                 | A          | C    | D    | E    |        |
| Dimensions, in. |           |                 |            |      |      |      | lb     |
| 1 1/4           | 1 11/16   | MS-BW-20(1.69)  | 3.16       | 18.0 | 22.8 | 0.73 | 3      |
|                 | 1 3/4     | MS-BW-20(1.75)  |            |      |      |      |        |
| 1 1/2           | 2         | MS-BW-24(2.00)  | 3.88       | 26.1 | 33.2 | 0.99 | 6      |
|                 | 2 1/8     | MS-BW-24(2.13)  |            |      |      |      |        |
| 2               | 2 3/4     | MS-BW-32(2.75)  | 5.06       | 32.5 | 42.0 | 1.25 | 11     |
| Dimensions, cm  |           |                 |            |      |      |      | kg     |
| 32              | 46        | MS-BW-32M(46M)  | 8.53       | 46.2 | 58.4 | 1.85 | 1.4    |
|                 | 50        | MS-BW-32M(50M)  |            |      |      |      |        |
| 38              | 60        | MS-BW-38M(55M)  | 10.1       | 66.6 | 84.6 | 2.51 | 3.2    |
| 50              | 2 3/4 in. | MS-BW-32(2.75)  | 12.9       | 82.6 | 107  | 3.18 | 5.0    |

## Tools and Accessories

### Gap Inspection Gauges

Swagelok gap inspection gauges assure the installer or inspector that the fitting has been sufficiently pulled up on initial installation, whether using a Swagelok multihead hydraulic swaging unit (MHSU), page 55, or air-actuated hydraulic swaging unit (AHSU), page 56, or wrench tightening. All metal Swagelok tube fittings are gaugeable, with the exception of a few forged bodies in aluminum.



#### For Installation Using the AHSU

| Fitting Size      |              | Ordering Number |
|-------------------|--------------|-----------------|
| in.               | mm           |                 |
| <b>Female Nut</b> |              |                 |
| 1/4, 3/8, 1/2     | —            | MS-AHSU-IG-468  |
| —                 | 6, 8, 10, 12 | MS-AHSU-IG-612M |

#### For Installation Using the MHSU

| Fitting Size      |            | Ordering Number      |
|-------------------|------------|----------------------|
| in.               | mm         |                      |
| <b>Female Nut</b> |            |                      |
| 1/2 <sup>①</sup>  | 12         | MS-MHSU-IG-810       |
| 5/8 <sup>②</sup>  | 14, 15, 16 | MS-MHSU-IG-1010      |
| 5/8 (SAF 2507)    | —          | MS-MHSU-IG-2507-1010 |
| 3/4 <sup>②</sup>  | 18         | MS-MHSU-IG-1210      |
| 3/4 (SAF 2507)    | —          | MS-MHSU-IG-2507-1210 |
| 7/8               | 20, 22     | MS-MHSU-IG-1410      |
| 1                 | 25         | MS-MHSU-IG-1610-1    |
| —                 | 28         | MS-MHSU-IG-28M0-1    |
| —                 | 30         | MS-MHSU-IG-30M0-1    |
| 1 1/4             | —          | MS-MHSU-IG-2000-2    |
| —                 | 32         | MS-MHSU-IG-32M0-1    |
| —                 | 38         | MS-MHSU-IG-38M0-1    |
| 1 1/2             | —          | MS-MHSU-IG-2400-1    |
| —                 | 50         | MS-MHSU-IG-50M0-1    |
| 2                 | —          | MS-MHSU-IG-3200-1    |

① The MHSU cannot be used for SAF 2507 tubing 1/2 in. and under or for medium pressure tubing.

② For 5/8 and 3/4 in. SAF 2507 tubing, order the 1 in. (25 mm) and over unit and SAF 2507 tooling and gauge.

#### For Installation Using a Wrench

| Fitting Size                    |              | Ordering Number |
|---------------------------------|--------------|-----------------|
| in.                             | mm           |                 |
| <b>Female Nut</b>               |              |                 |
| 1/16                            | —            | MS-IG-100       |
| 1/8                             | 2, 3         | MS-IG-200       |
| 3/16                            | 4            | MS-IG-300       |
| 1/4                             | 6            | MS-IG-400       |
| 1/4, 3/8, 1/2                   | 6, 12        | MS-IG-468       |
| 1/4, 1/2                        | 6, 8, 10, 12 | MS-IG-612M      |
| 5/16                            | 8            | MS-IG-500       |
| 3/8                             | —            | MS-IG-600       |
| —                               | 10           | MS-IG-10M0      |
| 1/2                             | 12           | MS-IG-810       |
| 5/8                             | 14, 15, 16   | MS-IG-1010      |
| 5/8 (SAF 2507)                  | —            | MS-IG-2507-1010 |
| 3/4                             | 18           | MS-IG-1210      |
| 3/4 (SAF 2507)                  | —            | MS-IG-2507-1210 |
| 7/8                             | 20, 22       | MS-IG-1410      |
| 1                               | 25           | MS-IG-1610      |
| <b>Male Nut</b>                 |              |                 |
| 1/16                            | —            | MS-IG-1F0       |
| 1/8                             | 2, 3         | MS-IG-2F0       |
| 1/4, 3/8, 1/2 (medium-pressure) | —            | MS-IG-FK0       |

### Depth Marking Tools



Swagelok depth marking tools help ensure that tubing is bottomed on the shoulder inside the Swagelok tube fitting body.

| Tube OD                | Ordering Number |
|------------------------|-----------------|
| <b>Dimensions, in.</b> |                 |
| 1/4                    | MS-DMT-400      |
| 3/8                    | MS-DMT-600      |
| 1/2                    | MS-DMT-810      |
| 5/8                    | MS-DMT-1010     |
| 3/4                    | MS-DMT-1210     |
| 7/8                    | MS-DMT-1410     |
| 1                      | MS-DMT-1610     |

| Tube OD               | Ordering Number |
|-----------------------|-----------------|
| <b>Dimensions, mm</b> |                 |
| 6                     | MS-DMT-6M0      |
| 8                     | MS-DMT-8M0      |
| 10                    | MS-DMT-10M0     |
| 12                    | MS-DMT-12M0     |
| 16                    | MS-DMT-16M0     |
| 18                    | MS-DMT-18M0     |

## Tools and Accessories

### Bulkhead Retainers

By using the bulkhead retainer, one person can tighten the jam nut on side A for initial bulkhead fitting installation. Now tubing can be connected to side A and B by one person with one wrench, because the bulkhead retainer acts as a backup wrench.

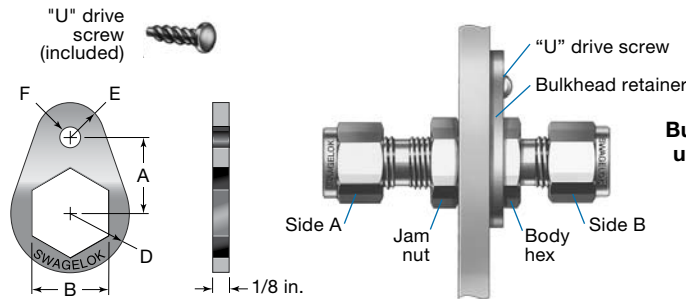

**Bulkhead fitting installation utilizing bulkhead retainer**

| Fitting Size |        | Ordering Number | Dimensions, in. |        |        |       |      | Drill Hole Dia | "U" Drive Screw Size | Drill Number |
|--------------|--------|-----------------|-----------------|--------|--------|-------|------|----------------|----------------------|--------------|
|              |        |                 | A               | B      | D      | E     | F    |                |                      |              |
| 1/16         | —      | SS-102-61F      | 3/8             | 5/16   | 5/16   | 5/32  | 5/32 | 0.120          | 6-3/8                | 31           |
| 1/8          | —      | SS-202-61F      | 1/2             | 1/2    | 13/32  | 7/32  |      |                |                      |              |
| 3/16         | 3, 4   | SS-302-61F      | 9/16            | 9/16   | 15/32  | 1/4   |      |                |                      |              |
| 1/4          | 6      | SS-402-61F      | 5/8             | 5/8    | 1/2    | 9/32  |      |                |                      |              |
| 5/16         | —      | SS-502-61F      | 11/16           | 11/16  | 9/16   | 5/16  |      |                |                      |              |
| —            | 8      | SS-8M2-61F      | 11/16           | 18 mm  | 9/16   | 5/16  |      |                |                      |              |
| 3/8          | —      | SS-602-61F      | 3/4             | 3/4    | 5/8    | 11/32 |      |                |                      |              |
| —            | 10     | SS-10M2-61F     | 15/16           | 22 mm  | 3/4    | 13/32 | 7/32 | 0.144          | 10-1/2               | 27           |
| 1/2          | 12     | SS-812-61F      | 15/16           | 15/16  | 3/4    | 13/32 |      |                |                      |              |
| 5/8          | 15, 16 | SS-1012-61F     | 1               | 1 1/16 | 13/16  | 13/32 |      |                |                      |              |
| 3/4          | 18     | SS-1212-61F     | 1 1/16          | 1 3/16 | 29/32  | 15/32 |      |                |                      |              |
| 7/8          | —      | SS-1412-61F     | 1 1/8           | 1 5/16 | 1 1/32 | 17/32 |      |                |                      |              |
| 1            | —      | SS-1612-61F     | 1 9/32          | 1 5/8  | 1 5/32 | 9/16  |      |                |                      |              |

### Inserts for Soft Plastic Tubing

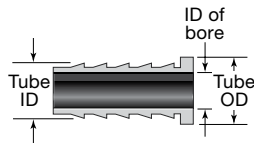

Swagelok inserts help secure soft plastic tubing being used with standard Swagelok tube fittings. To determine the correct size of the Swagelok insert to be used, check both outside diameter and inside diameter of the plastic tubing.

For a complete line of hose connectors for soft plastic tubing, see the Swagelok *Hose and Flexible Tubing* catalog, MS-01-180.

#### Ordering Information

Add the insert material designator to the basic ordering number.

Example: **B-305-2**

| Material        | Designator |
|-----------------|------------|
| Alloy 400       | M          |
| Aluminum        | A          |
| Brass           | B          |
| Carbon steel    | S          |
| Nylon           | NY         |
| Stainless steel | SS         |

| Tube OD                | Tube ID | Bore ID | Basic Ordering Number |
|------------------------|---------|---------|-----------------------|
| <b>Dimensions, in.</b> |         |         |                       |
| 3/16                   | 1/8     | 0.09    | -305-2                |
| 1/4                    | 1/8     | 0.09    | -405-2                |
|                        | 0.17    | 0.11    | -405-170              |
| 5/16                   | 3/16    | 0.14    | -405-3                |
|                        | 1/8     | 0.09    | -505-2                |
|                        | 3/16    | 0.12    | -505-3                |
| 3/8                    | 1/4     | 0.19    | -505-4                |
|                        | 3/16    | 0.12    | -605-3                |
|                        | 1/4     | 0.19    | -605-4                |
| 1/2                    | 1/4     | 0.19    | -815-4                |
|                        | 3/8     | 0.31    | -815-6                |
| 5/8                    | 3/8     | 0.31    | -1015-6               |
|                        | 1/2     | 0.44    | -1015-8               |
| 3/4                    | 1/2     | 0.44    | -1215-8               |
|                        | 5/8     | 0.56    | -1215-10              |
| 1                      | 3/4     | 0.69    | -1615-12              |
| <b>Dimensions, mm</b>  |         |         |                       |
| 6                      | 4       | 2.8     | -6M5-4M               |
| 8                      | 6       | 4.4     | -8M5-6M               |
| 10                     | 8       | 6.4     | -10M5-8M              |
| 12                     | 8       | 6.4     | -12M5-8M              |
|                        | 10      | 8.3     | -12M5-10M             |

## Gaugeability

On initial installation, the Swagelok gap inspection gauge assures the installer or inspector that a fitting has been sufficiently tightened.

Position the Swagelok gap inspection gauge next to the gap between the nut and body.

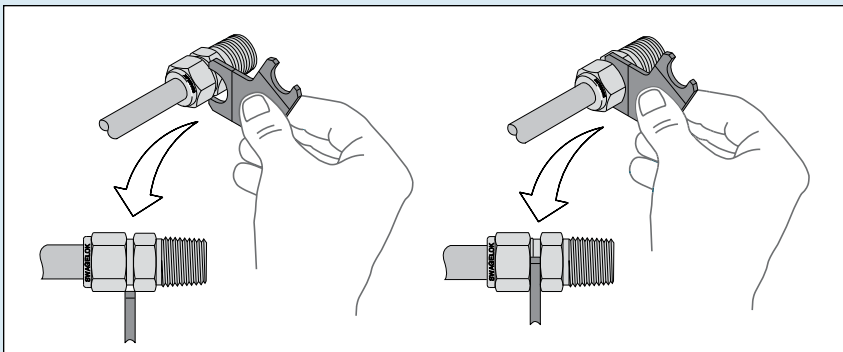

If the gauge **will not** enter the gap, the fitting is sufficiently tightened.

If the gauge **will** enter the gap, additional tightening is required.

**⚠ Always depressurize a system before adjusting the tightness of a tube fitting connection.**

## Installation Instructions

Swagelok tube fittings 1 in./25 mm and smaller can be installed quickly, easily, and reliably with simple hand tools.

Over 1 in./25 mm sizes require use of a hydraulic swaging unit to swage the ferrules onto the tubing.

### Safety Precautions

- Do not bleed system by loosening fitting nut or fitting plug.
- Do not assemble or tighten fittings when system is pressurized.
- Make sure that the tubing rests firmly on the shoulder of the tube fitting body before tightening the nut.
- Use the correct Swagelok gap inspection gauge to ensure sufficient pull-up upon initial installation.
- Always use proper thread sealants on tapered pipe threads.
- Do not mix materials or fitting components from various manufacturers—tubing, ferrules, nuts, and fitting bodies.
- Never turn fitting body. Instead, hold fitting body and turn nut.
- Avoid unnecessary disassembly of unused fittings.
- Use only long reducers in female Swagelok end connections.

See the instructions starting on the next page for installation of Swagelok tube fittings, O-seal male connectors, caps and plugs, port connectors, tube adapters, positionable elbows and tees, weld fittings, depth marking tool, and preswaging tool.

### Tubing Considerations

- Metal tubing material should be softer than fitting material. For example, stainless steel tubing should not be used with brass fittings.
- When tubing and fittings are made of the same material, tubing must be fully annealed.
- Always use an insert with extremely soft or pliable plastic tubing.
- Extremes of wall thickness should always be checked against the suggested minimum and maximum wall thickness limitations.
- Surface finish is very important to proper sealing. Tubing with any kind of depression, scratch, raised portion, or other surface defect will be difficult to seal, particularly in gas service.
- Tubing that is oval and will not easily fit through fitting nuts, ferrules, and bodies should never be forced into the fitting. See Swagelok *Tubing Data*, MS-01-107, for more information about tubing selection.

## Installation Instructions

### Swagelok Tube Fittings Up to 1 in./25 mm

These instructions apply both to traditional fittings and to fittings with the advanced back-ferrule geometry.

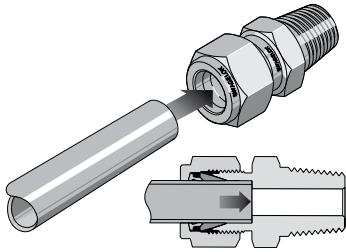

Fully insert the tube into the fitting and against the shoulder; rotate the nut finger-tight.

**High-pressure applications and high safety-factor systems:** Further tighten the nut until the tube will not turn by hand or move axially in the fitting.

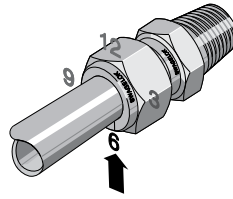

Mark the nut at the 6 o'clock position.

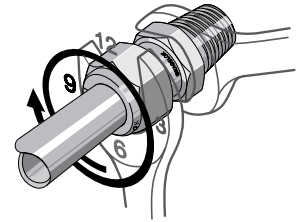

While holding the fitting body steady, tighten the nut one and one-quarter turns to the 9 o'clock position.

For 1/16, 1/8, and 3/16 in.; 2, 3, and 4 mm tube fittings, tighten the nut only three-quarters turn to the 3 o'clock position.

### Swagelok Tube Fittings Over 1 in./25 mm

1. Preswage the ferrules onto the tube using a Swagelok multihead hydraulic swaging unit (MHSU).
2. Apply the lubricant packaged with the fitting lightly to the body threads and the rear surface of the back ferrule.
3. Insert the tube with preswaged ferrules into the fitting until the front ferrule seats against the fitting body; rotate the nut finger-tight.
4. Mark the nut at the 6 o'clock position.

5. While holding the fitting body steady, tighten the nut one-half turn to the 12 o'clock position.

Use the Swagelok MHSU gap inspection gauge to ensure that the fitting has been tightened sufficiently.

### Reassembly—All Sizes

You may disassemble and reassemble Swagelok tube fittings many times.

**⚠ Always depressurize the system before disassembling a Swagelok tube fitting.**

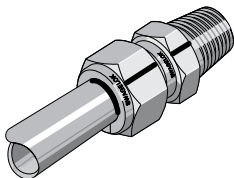

Prior to disassembly, mark the tube at the back of the nut; mark a line along the nut and fitting body flats.

Use these marks to ensure that you return the nut to the previously pulled-up position.

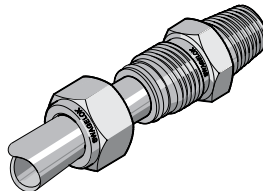

Insert the tube with preswaged ferrules into the fitting until the front ferrule seats against the fitting body.

**Over 1 in./25 mm sizes:** If needed, reapply lubricant lightly to the body threads and the rear surface of the back ferrule.

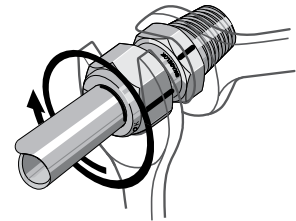

While holding the fitting body steady, rotate the nut with a wrench to the previously pulled-up position, as indicated by the marks on the tube and flats. At this point, you will feel a significant increase in resistance. Tighten the nut slightly.

**⚠ Do not use the Swagelok gap inspection gauge with reassembled fittings.**

### O-Seal Male Connectors

1. Turn the O-seal connector into the female end until it is finger-tight.
2. Tighten the O-seal connector until it makes metal-to-metal contact with the face of the female end.
3. Tighten slightly with a wrench.

## Installation Instructions

### Caps and Plugs



#### Caps

See Swagelok tube fitting installation and reassembly, page 63.



#### Plugs

While holding fitting body steady, tighten the plug one-quarter turn from the finger-tight position.

*For 1/16, 1/8, and 3/16 in.; 2, 3, and 4 mm tube fittings, tighten the plug one-eighth turn.*  
*For over 1 in./25 mm tube fittings, tighten the plug one-quarter turn.*

#### Reassembly

You may disassemble and reassemble Swagelok plugs many times. Make subsequent connections by slightly tightening with a wrench after snugging the nut by hand.

### Port Connectors

Fig. 1



Fig. 2

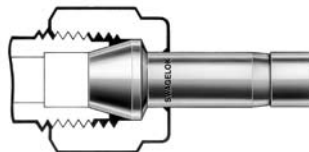
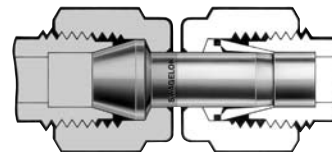

Fig. 3



#### Machined Ferrule End

While holding fitting body steady, tighten the port connector one-quarter turn from the finger-tight position.

*For 1/16, 1/8, and 3/16 in.; 2, 3, and 4 mm tube fittings, tighten the port connector one-eighth turn.*

*For over 1 in. and over 25 mm tube fittings, tighten the port connector one-quarter turn.*

#### Reassembly

You may disassemble and reassemble Swagelok port connectors many times. Make subsequent connections by slightly tightening with a wrench after snugging the nut by hand.

#### Tube Adapter End

1. Insert the tube adapter into the Swagelok tube fitting. Make sure that the tube adapter rests firmly on the shoulder of the tube fitting body and that the nut is finger-tight (Fig. 3).
2. Mark the nut at the 6 o'clock position.
3. While holding fitting body steady, tighten the nut one and one-quarter turns to the 9 o'clock position.

*For 1/16, 1/8, and 3/16 in.; 2, 3, and 4 mm tube fittings, tighten the nut only three-quarters turn to the 3 o'clock position.*

#### Reassembly

See Swagelok tube fitting reassembly, page 63.

### Tube Adapters

Fig. 1



Female pipe port on existing equipment

Fig. 2



#### Up to 1 in./25 mm

1. Install the end opposite the tube adapter end (Fig. 1).
2. Insert the tube adapter into the Swagelok tube fitting. Make sure that the tube adapter rests firmly on the shoulder of the tube fitting body and that the nut is finger-tight (Fig. 2).
3. Mark the nut at the 6 o'clock position.
4. While holding fitting body steady, tighten the nut one and one-quarter turns to the 9 o'clock position.

*For 1/16, 1/8, and 3/16 in.; 2, 3, and 4 mm tube fittings, tighten the nut only three-quarters turn to the 3 o'clock position.*

#### Over 1 in./25 mm

Swagelok tube adapters over 1 in./25 mm are furnished with nuts and preswaged ferrules.

To assemble, follow steps 2 through 5 of the Swagelok tube fittings over 1 in./25 mm assembly instructions, page 63.

**⚠ Do not use the Swagelok gap inspection gauge with preswaged tube adapter connections over 1 in./25 mm.**

#### Reassembly

See Swagelok tube fitting reassembly, page 63.



## Installation Instructions

### Positionable Elbows and Tees

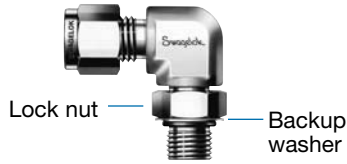

1. Turn the positionable end into the female fitting until the metal backup washer contacts the face of the fitting.
2. Turn the positionable end out of the female fitting (not more than one turn) until the Swagelok tube fitting end is positioned properly.
3. While holding fitting body steady, tighten the lock nut until the metal backup washer contacts the face of the fitting.

## Weld Fittings

### Welding Precautions for Swagelok Tube Fittings with Weld End Connections

1. Remove the nut and ferrules.
  2. Turn a Swagelok tube fitting plug or another nut onto the fitting so that it is finger-tight. This protects the threads and sealing components.
  3. Provide a suitable heat sink to dissipate the heat.
  4. Tack weld at four positions 90° apart to hold the fitting in place and to ensure alignment and concentricity of the components.
  5. Complete the weld.
  6. Remove the plug or nut and replace the nut and ferrules.
- ⚠ Caution: When welding carbon steel fittings, the heat often removes the protective oil from the threads. It is important to apply another lubricant, such as Goop® thread lubricant.**

## Depth Marking Tool

Fig. 1



Fig. 2



1. Insert cleanly cut, fully deburred tube into the depth marking tool (DMT) until the tube is against the shoulder of the tool. Using a pen or pencil, mark the tube at the top of the DMT (Fig. 1).
2. Remove the tube from the DMT and insert it into the Swagelok fitting until it is against the shoulder of the fitting body (Fig. 2). Rotate the nut finger-tight. If any portion of the mark on the tube can be seen above the fitting nut, the tube is not fully inserted into the fitting.
3. While holding the fitting body steady, follow Swagelok tube fitting installation instructions, page 63.

## Preswaging Tool

Fig. 1

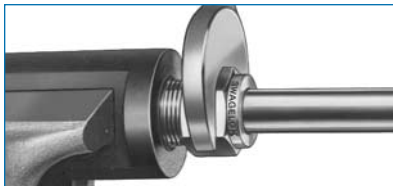

Fig. 2



Fig. 3



1. Install the Swagelok nut and ferrules onto the preswaging tool.
  2. Insert the tube into the preswaging tool.
  3. Make sure that the tube rests firmly on the shoulder of the preswaging tool body and that the nut is finger-tight.
  4. Mark the nut at the 6 o'clock position.
  5. While holding the preswaging tool steady, tighten the nut one and one-quarter turns to the 9 o'clock position.  
*For 1/16, 1/8, and 3/16 in.; 2, 3, and 4 mm tube fittings, tighten the nut only three-quarters turn to the 3 o'clock position (Fig. 1).*
  6. Loosen the nut.
  7. Remove the tube with preswaged ferrules from the preswaging tool. If the tube sticks in the preswaging tool, remove the tube by gently rocking it back and forth. Do not turn the tube (Fig. 2).
  8. Insert the tube with preswaged ferrules into the fitting until the front ferrule seats against the fitting body.
  9. While holding the fitting body steady, rotate the nut with a wrench to the previously pulled-up position; at this point, you will feel a significant increase in resistance.
  10. Tighten the nut slightly (Fig. 3).
- ⚠ Do not use the Swagelok gap inspection gauge with fittings that were assembled using the preswaging tool.**



## Tubing Tools and Accessories

For tube benders, tube preparation tools, and tube support systems, see the Swagelok *Tubing Tools and Accessories* catalog, MS-01-179.

## Leak Detectors, Lubricants, and Sealants

For liquid leak detectors, lubricants, and sealants, see the Swagelok *Leak Detectors, Lubricants, and Sealants* catalog, MS-01-91.



## Tubing Products

Swagelok offers a wide variety of tubing products.

Contact your authorized Swagelok representative or see these Swagelok catalogs for more information:



- *Stainless Steel Seamless Tubing, Fractional Sizes*, MS-01-153-SCS
- *Stainless Steel Welded Tubing*, MS-01-161-SCS
- *Stainless Steel Tubing, Metric Sizes*, MS-01-157-SCS
- *Stainless Steel Tubing, Imperial Sizes*, MS-01-159-SCS

### Safe Product Selection

**When selecting a product, the total system design must be considered to ensure safe, trouble-free performance. Function, material compatibility, adequate ratings, proper installation, operation, and maintenance are the responsibilities of the system designer and user.**

**Caution: Do not mix or interchange parts with those of other manufacturers.**

## Warranty Information

Swagelok products are backed by The Swagelok Limited Lifetime Warranty. For a copy, visit [swagelok.com](http://swagelok.com) or contact your authorized Swagelok representative.

Swagelok, VCR, VCO, Snoop, Goop, SWAK, Ferrule-Pak—TM Swagelok Company  
Krytox—TM DuPont  
SAF 2507—TM Sandvik AB  
© 2006, 2007, 2008, 2009 Swagelok Company  
Printed in U.S.A., MI  
July 2009, R11  
MS-01-140