

# Rosemount 3144P Temperature Transmitter



This product is a core component of the PlantWeb digital plant architecture.

**ROSEMOUNT**

[www.rosemount.com](http://www.rosemount.com)



**EMERSON**  
Process Management



# Rosemount 3144P Temperature Transmitter

## NOTICE

Read this manual before working with the product. For personal and system safety, and for optimum product performance, make sure you thoroughly understand the contents before installing, using, or maintaining this product.

Within the United States, Rosemount Inc. has two toll-free assistance numbers:

**Customer Central**

Technical support, quoting, and order-related questions.  
1-800-999-9307 (7:00 am to 7:00 pm CST)

**North American Response Center**

Equipment service needs.  
1-800-654-7768 (24 hours)

**International**

(952)-906-8888

## ⚠ CAUTION

The products described in this document are NOT designed for nuclear-qualified applications. Using non-nuclear qualified products in applications that require nuclear-qualified hardware or products may cause inaccurate readings.

For information on Rosemount nuclear-qualified products, contact your local Emerson Process Management Sales Representative.

Rosemount 3144P Temperature Transmitter may be protected by one or more U.S. Patents Pending. Other foreign patents pending.





## Table of Contents

<b>SECTION 1</b> <b>Introduction</b>	Overview . . . . .	1-1
	Manual . . . . .	1-1
	Transmitter . . . . .	1-2
	Considerations . . . . .	1-2
	General . . . . .	1-2
	Electrical . . . . .	1-2
	Environmental . . . . .	1-3
	Moist or Corrosive Environments . . . . .	1-3
	Mounting . . . . .	1-4
	Software Compatibility . . . . .	1-4
	Return of Materials . . . . .	1-5
	Rosemount 3144P and Rosemount 3144 / 3244MV Differences . . . . .	1-6
	<b>SECTION 2</b> <b>Installation</b>	Safety Messages . . . . .
Commissioning . . . . .		2-2
Setting the Loop to Manual . . . . .		2-2
Set the Switches . . . . .		2-3
Mounting . . . . .		2-4
Installation . . . . .		2-6
Typical North American Installation . . . . .		2-6
Typical European Installation . . . . .		2-7
In Conjunction with a Rosemount 333 HART Tri-Loop (HART / 4–20 mA only) . . . . .		2-8
LCD Display . . . . .		2-9
Multichannel Installation (HART / 4–20 mA only) . . . . .		2-10
Wiring . . . . .		2-10
HART / 4–20 mA . . . . .		2-10
Foundation Fieldbus . . . . .		2-13
Sensor Connections . . . . .		2-14
Power Supply . . . . .		2-14
Surges/Transients . . . . .		2-15
Grounding . . . . .		2-15

**SECTION 3**  
**HART Commissioning**

Overview . . . . .	3-1
Safety Messages . . . . .	3-1
375 Field Communicator . . . . .	3-2
Updating the HART Communication Software . . . . .	3-2
Menu Tree . . . . .	3-3
Fast Key Sequences . . . . .	3-4
AMS . . . . .	3-5
Apply AMS Changes . . . . .	3-5
Review Configuration Data . . . . .	3-5
Check Output . . . . .	3-6
Configuration . . . . .	3-6
Device Output Configuration . . . . .	3-14
Device Information . . . . .	3-18
Measurement Filtering . . . . .	3-19
Diagnostics and Service . . . . .	3-21
Multidrop Communication . . . . .	3-24
Use with the HART Tri-Loop . . . . .	3-25
Calibration . . . . .	3-28
Trim the Transmitter . . . . .	3-28
Sensor Input Trim . . . . .	3-29
Transmitter-Sensor Matching . . . . .	3-32
D/A Output Trim or Scaled Output Trim . . . . .	3-33
Output Trim . . . . .	3-33
Scaled Output Trim . . . . .	3-34
Troubleshooting . . . . .	3-35
HART / 4–20 mA . . . . .	3-35
LCD Display . . . . .	3-38
AMS Software (HART / 4-20 mA only) . . . . .	3-39
AMS Screens . . . . .	3-41

**SECTION 4**  
**Foundation Fieldbus**  
**Configuration**

Overview . . . . .	4-1
Safety Messages . . . . .	4-1
General Block Information . . . . .	4-2
Device Description . . . . .	4-2
Node Address . . . . .	4-2
Modes . . . . .	4-2
Link Active Scheduler . . . . .	4-3
Block Instantiation . . . . .	4-3
Capabilities . . . . .	4-4
Foundation fieldbus function blocks . . . . .	4-4
Resource Block . . . . .	4-5
FEATURES and FEATURES_SEL . . . . .	4-5
PlantWeb™ Alerts . . . . .	4-7
Recommended Actions for PlantWeb Alerts . . . . .	4-9
Resource Block Diagnostics . . . . .	4-9
Sensor Transducer Block . . . . .	4-10
Damping . . . . .	4-10
Sensor Transducer Block Diagnostics . . . . .	4-10
LCD Transducer Block . . . . .	4-11
Custom Meter Configuration . . . . .	4-12
Self Test Procedure for the LCD . . . . .	4-13
LCD Transducer Block Diagnostics . . . . .	4-13

	Analog Input (AI) . . . . .	4-14
	Simulation . . . . .	4-14
	Configure the AI block . . . . .	4-14
	Filtering . . . . .	4-17
	Process Alarms . . . . .	4-17
	Status . . . . .	4-18
	Advanced Features . . . . .	4-18
	Analog Input Diagnostics . . . . .	4-19
	Operation . . . . .	4-20
	Overview . . . . .	4-20
	Trim the Transmitter . . . . .	4-20
	Statistical Process Monitoring (SPM) . . . . .	4-22
	SPM Configuration . . . . .	4-23
	Troubleshooting Guides . . . . .	4-25
	Foundation Fieldbus . . . . .	4-28
	LCD Display . . . . .	4-29
<b>SECTION 5</b>		
<b>Maintenance</b>	Safety Messages . . . . .	5-1
	Maintenance . . . . .	5-2
	Test Terminal (HART / 4–20 mA only) . . . . .	5-2
	Sensor Checkout . . . . .	5-2
	Electronics Housing . . . . .	5-2
<b>SECTION 6</b>		
<b>Certified Safety</b>		
<b>Instrumented System</b>		
<b>(SIS)</b>	Safety Messages . . . . .	6-1
	Certification . . . . .	6-1
	3144P SIS Identification . . . . .	6-1
	Installation . . . . .	6-2
	Commissioning . . . . .	6-2
	Configuration . . . . .	6-2
	SIS Additions . . . . .	6-3
	Transmitter Diagnostics Logging . . . . .	6-3
	375 Field communicator . . . . .	6-4
	3144P SIS Menu Tree . . . . .	6-4
	3144P SIS Fast Key Sequences . . . . .	6-5
	Operation and Maintenance . . . . .	6-6
	Proof Test . . . . .	6-6
	Inspection . . . . .	6-7
	Specifications . . . . .	6-7
	Failure Rate Data . . . . .	6-7
	Product Life . . . . .	6-7
	Spare Parts . . . . .	6-7
<b>SECTION 7</b>		
<b>Prior Use (PU) Safety</b>		
<b>Instrumented System</b>	Overview . . . . .	7-1
	Safe Failure Fraction . . . . .	7-2
	Installation . . . . .	7-2
	Switches . . . . .	7-2
	Changing Switch Position . . . . .	7-3

**APPENDIX A**  
**Reference Data**

HART and Foundation Fieldbus Specifications . . . . .	A-1
Functional Specifications . . . . .	A-1
Physical Specifications . . . . .	A-1
Performance Specifications . . . . .	A-2
HART / 4–20 mA Specifications . . . . .	A-6
Foundation Fieldbus Specifications . . . . .	A-8
Dimensional Drawings . . . . .	A-10
Ordering Information . . . . .	A-14

**APPENDIX B**  
**Product Certifications**

Rosemount 3144P With HART / 4–20 mA . . . . .	B-1
Approved Manufacturing Locations . . . . .	B-1
European Union Directive Information . . . . .	B-1
Hazardous Locations Installations . . . . .	B-1
Rosemount 3144P With Foundation fieldbus . . . . .	B-6
Approved Manufacturing Locations . . . . .	B-6
European Union Directive Information . . . . .	B-6
Hazardous Locations Installations . . . . .	B-6
Installation Drawings . . . . .	B-9



---

# Section 1 Introduction

---

Overview .....	page 1-1
Considerations .....	page 1-2
Return of Materials .....	page 1-5
Rosemount 3144P and Rosemount 3144 / 3244MV Differences	page 1-6

---

## OVERVIEW

### Manual

This manual is designed to assist in the installation, operation, and maintenance of the Rosemount 3144P.

#### Section 1: Introduction

- Transmitter and Manual Overview
- Considerations
- Return of Material

#### Section 2: Installation

- Mounting
- Installation
- Wiring
- Power Supply

#### Section 3: HART Configuration

- 375 Field Communicator
- Configuration
- Multidrop Communication
- Calibration
- Trim the transmitter

#### Section 4: FOUNDATION Fieldbus Configuration

- Calibration
- Hardware Maintenance
- Diagnostic Messaging
- Trim the Transmitter

#### Section 5: Operation and Maintenance

- Maintenance
- Troubleshooting

## Appendix A: Specifications and Reference Data

- Specifications
- Dimensional drawings
- Ordering Information

## Appendix B: Approvals

- Product Certifications
- Installation Drawings

## Safety Instrumented System (SIS) – HART only

- Information regarding Safety Certified transmitters

## Transmitter

### Features of the Rosemount 3144P include:

- Accepts inputs from a wide variety of sensors
- Configuration using HART protocol or FOUNDATION fieldbus
- Electronics that are completely encapsulated in epoxy and enclosed in a metal housing, making the transmitter extremely durable and ensuring long-term reliability
- A compact size and two housing options allowing mounting flexibility for the control room or the field
- Special dual-sensor features include Hot Backup<sup>®</sup>, sensor drift alarm, first good, differential and average temperature measurements, and four simultaneous measurement variable outputs in addition to the analog output signal

Refer to the following literature for a full range of compatible connection heads, sensors, and thermowells provided by Emerson Process Management.

- Temperature Sensors and Assemblies Product Data Sheet, Volume 1 (document number 00813-0100-2654)
- Temperature Sensors and Assemblies Product Data Sheet, Metric (document number 00813-0200-2654)

## CONSIDERATIONS

### General

Electrical temperature sensors, such as resistance temperature detectors (RTDs) and thermocouples (T/Cs), produce low-level signals proportional to temperature. The 3144P transmitter converts low-level signals to HART or FOUNDATION fieldbus signals. This signal is then transmitted to the control room via two power/signal wires.

### Electrical

Proper electrical installation is essential to prevent errors due to sensor lead resistance and electrical noise. The current loop must have between 250 and 1100 ohms resistance for HART communications. Refer to Figure 2-10 on page 2-11 for sensor and current loop connections. FOUNDATION fieldbus devices must have proper termination and power conditioning for reliable operation. Shield cables must be used for FOUNDATION fieldbus and the shield may only be grounded in one place.

**Environmental**

**Temperature Effects**

The transmitter will operate within specifications for ambient temperatures between -40 and 185 °F (-40 and 85 °C). Heat from the process is transferred from the thermowell to the transmitter housing. If the expected process temperature is near or beyond specification limits, consider the use of additional thermowell lagging, an extension nipple, or a remote mounting configuration to isolate the transmitter from the process. Figure 1-1 describes the relationship between housing temperature rise and extension length.

Figure 1-1. 3144P Transmitter Housing Temperature Rise versus Extension Length for a Test Installation.

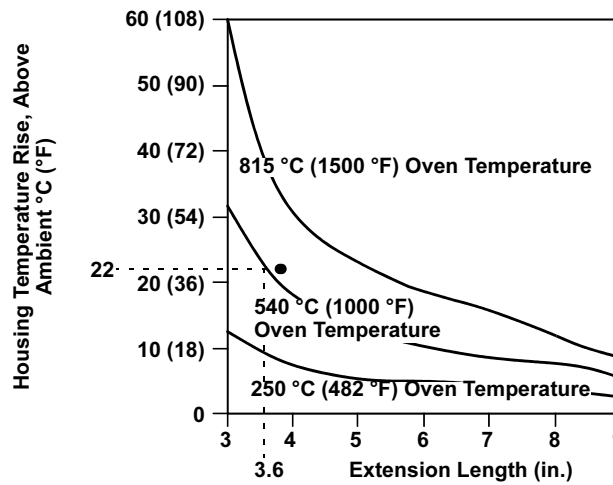

3044-0123A

**Example:**

The maximum permissible housing temperature rise (T) can be calculated by subtracting the maximum ambient temperature (A) from the transmitter’s ambient temperature specification limit (S). For instance, suppose A = 40 °C.

$$T = S - A$$

$$T = 85 \text{ °C} - 40 \text{ °C}$$

$$T = 45 \text{ °C}$$

For a process temperature of 540 °C (1004 °F), an extension length of 3.6 inches (91.4 mm) yields a housing temperature rise (R) of 22 °C (72 °F), which provides a safety margin of 23 °C (73 °F). A six-inch extension length (R = 10 °C (50 °F)) would offer a higher safety margin (35 °C (95 °F)) and would reduce temperature-effect errors but would probably require extra transmitter support. Gauge the requirements for individual applications along this scale. If a thermowell with lagging is used, the extension length may be reduced by the length of the lagging.

**Moist or Corrosive Environments**

The 3144P temperature transmitter has a highly reliable dual compartment housing designed to resist moisture and corrosion. The sealed electronics module is mounted in a compartment that is isolated from the terminal side conduit entries. O-ring seals protect the interior when the covers are properly installed. In humid environments, however, it is possible for moisture to accumulate in conduit lines and drain into the housing.

---

**NOTE**

Each transmitter is marked with a tag indicating the approvals. Install the transmitter in accordance with all applicable installation codes and approval and installation drawings (see Appendix B: Product Certifications). Verify that the operating atmosphere of the transmitter is consistent with the hazardous locations certifications. Once a device labeled with multiple approval types is installed, it should not be reinstalled using any of the other labeled approval types. To ensure this, the approval label should be permanently marked to distinguish the used from the unused approval type(s).

---

**Mounting**

Take into account the need for access to the transmitter when choosing an installation location and position.

**Terminal Side of Electronics Housing**

Mount the transmitter so the terminal side is accessible. Allow adequate clearance for cover removal. Make wiring connections through the conduit openings on the bottom of the housing.

**Circuit Side of Electronics Housing**

Mount the transmitter so the circuit side is accessible. Provide adequate clearance for cover removal. Additional room is required for LCD installation. The transmitter may be mounted directly to or remotely from the sensor. Using optional mounting brackets, the transmitter may be mounted to a flat surface or to a two-inch diameter pipe (see "Optional Transmitter Mounting Brackets" on page A-8).

**Software Compatibility**

Replacement transmitters may contain revised software that is not fully compatible with the existing software. The 375 Field Communicator and AMS software containing device descriptors for the 3144 and 3244MV before December 2001 do not fully support the new features of the 3144P. The Device Descriptors (DD) are available with new communicators or can be loaded into existing communicators at any Emerson Process Management Service Center.

**RETURN OF MATERIALS**

To expedite the return process in North America, call the Emerson Process Management National Response Center (800-654-7768). This center, will assist you with any needed information or materials.

 The center will ask for the following information:

- Product model
- Serial numbers
- The last process material to which the product was exposed

The center will provide

- A Return Material Authorization (RMA) number
- Instructions and procedures that are necessary to return goods that were exposed to hazardous substances

For other locations, contact a Emerson Process Management representative.

---

**NOTE**

If a hazardous substance is identified, a Material Safety Data Sheet (MSDS), required by law to be available to people exposed to specific hazardous substances, must be included with the returned materials.

---

# Rosemount 3144P

## ROSEMOUNT 3144P AND ROSEMOUNT 3144 / 3244MV DIFFERENCES

The following table identifies the differences between the Rosemount 3144P and Rosemount 3144 and 3244MV Temperature Transmitters.

Improved Rosemount 3144P	Previous Rosemount 3144 and 3244MV
Field Device Revision number 3	Standard 3144P: Dev v3, DD v2 3144P SIS: Dev v1, DD v1 (for SIS)
Software Revision number 3	Software Revision number 1
Added sensor input types: DIN Type L, DIN Type U, and extended temperature range of Type N	NA
Uses custom-configurable alarm limits	Analog output and alarm levels can be ordered to be NAMUR-compliant with option codes A1 and CN
Improved 2- and 3-wire EMF compensation	NA
First Good Temperature is available as a device variable	NA
2-wire fixed lead correction is available	NA
Enhanced EMI rejection and filtering resulting in unmatched stability in process measurement	NA
Dual-sensor configuration is field selectable	Rosemount 3144 – single sensor Rosemount 3244MV – dual-sensor configuration

## Section 2 Installation

---

Safety Messages .....	page 2-1
Commissioning .....	page 2-2
Mounting .....	page 2-4
Installation .....	page 2-6
Wiring .....	page 2-10
Power Supply .....	page 2-14

---

### SAFETY MESSAGES

Instructions and procedures in this section may require special precautions to ensure the safety of the personnel performing the operations. Information that potentially raises safety issues is indicated by a warning symbol (⚠). Please refer to the following safety messages before performing an operation preceded by this symbol.

#### WARNING

##### **Explosions could result in death or serious injury:**

- Do not remove the transmitter cover in explosive atmospheres when the circuit is live.
- Before connecting a 375 Field Communicator in an explosive atmosphere, make sure the instruments in the loop are installed in accordance with intrinsically safe or non-incendive field wiring practices.
- Verify that the operating atmosphere of the transmitter is consistent with the appropriate hazardous locations certifications.
- Both transmitter covers must be fully engaged to meet explosion-proof requirements.

##### **Failure to follow these installation guidelines could result in death or serious injury:**

- Make sure only qualified personnel perform the installation.

##### **Process leaks could result in death or serious injury:**

- Install and tighten thermowells or sensors before applying pressure, or process leakage may result.
- Do not remove the thermowell while in operation. Removing while in operation may cause process fluid leaks.

##### **Electrical shock could cause death or serious injury. If the sensor is installed in a high-voltage environment and a fault or installation error occurs, high voltage may be present on the transmitter leads and terminals:**

- Use extreme caution when making contact with the leads and terminals.

# Rosemount 3144P

## COMMISSIONING

The 3144P must be configured for certain basic variables to operate. In many cases, all of these variables are pre-configured at the factory. Configuration may be required if the configuration variables need to be changed.

Commissioning consists of testing the transmitter and verifying transmitter configuration data. Rosemount 3144P transmitters can be commissioned either before or after installation. Commissioning the transmitter on the bench before installation using a 375 Field Communicator or AMS ensures that all transmitter components are in working order.

For more information on using the Field Communicator with the 3144P transmitter, see "HART Commissioning" on page 3-1. For more information on using the 3144 with Foundation fieldbus, see "Foundation Fieldbus Configuration" on page 4-1.

Figure 2-1. Installation Flowchart.

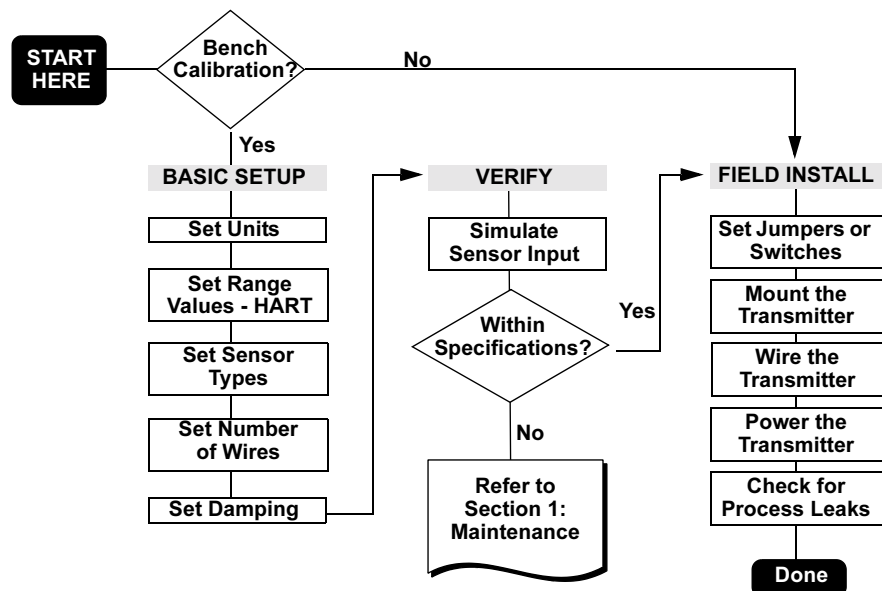

## Setting the Loop to Manual



When sending or requesting data that would disrupt the loop or change the output of the transmitter, set the process application loop to manual. The 375 Field Communicator or AMS will prompt you to set the loop to manual when necessary. Acknowledging this prompt does not set the loop to manual. The prompt is only a reminder; set the loop to manual as a separate operation.





## Set the Switches

### HART

#### Without a LCD display

1. If the transmitter is installed in a loop, set the loop to manual mode and disconnect power.
-  2. Remove the housing cover on the electronics side of the transmitter. Do not remove the transmitter cover in explosive atmospheres when the circuit is live.
3. Set the switches to the desired position (see Figure 2-1).
-  4. Replace the transmitter cover. Both transmitter covers must be fully engaged to meet explosion-proof requirements.
5. Apply power and set the loop to automatic mode.

#### With a LCD display

1. If the transmitter is installed in a loop, set the loop to manual mode and disconnect power.
-  2. Remove the housing cover on the electronics side of the transmitter. Do not remove the transmitter cover in explosive atmospheres when the circuit is live.
3. Remove the housing cover, unscrew the LCD display screws and gently slide the meter straight off.
4. Set the switches to the desired position (see Figure 2-1).
5. Gently slide the LCD display back into place, taking extra precautions of the 10 pin connection.
6. Secure the LCD display by replacing the LCD display screws.
-  7. Replace the transmitter cover. Both transmitter covers must be fully engaged to meet explosion-proof requirements.
8. Apply power and set the loop to automatic mode.

### Foundation Fieldbus

#### Without a LCD Display

1. If the transmitter is installed in a loop, set the loop to Out-of-Service (OOS) mode (if applicable) and disconnect the power.
2. Remove the electronics housing cover.
3. Set the switches to the desired position. Reattach housing cover.
4. Apply power and set the loop to In-Service mode.

#### With a LCD Display

1. If the transmitter is installed in a loop, set the loop to Out-of-Service (OOS) (if applicable) and disconnect the power.
2. Remove the electronics housing cover.
3. Unscrew the LCD display screws and pull the meter straight off.
4. Set the switches to the desired position.
5. Reattach the LCD display and electronics housing cover (consider LCD display orientation).
6. Apply power and set the loop to In-Service mode.

Table 2-1. Transmitter Switch Locations.

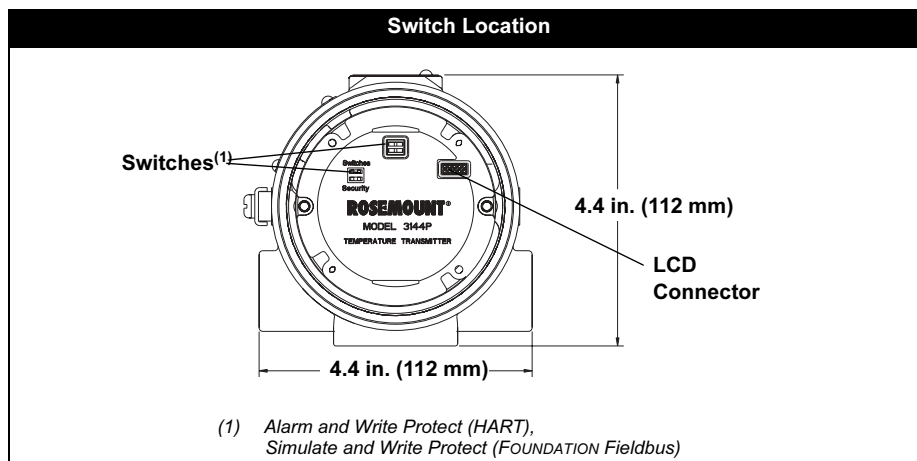

### Write Protect Switch (HART and FOUNDATION Fieldbus)

The transmitter is equipped with a write-protect switch that can be positioned to prevent the accidental or deliberate change of configuration data.

### Alarm Switch (HART)

The transmitter monitors itself during normal operation with an automatic diagnostic routine. If the diagnostic routine detects a sensor failure or a failure in the transmitter electronics, the transmitter goes into alarm (high or low, depending on the position of the failure mode switch).

The analog alarm and saturation values that the transmitter uses depend on whether it is configured to standard or NAMUR-compliant operation. These values are also custom-configurable in both the factory and the field using the HART Communications. The limits are

- $21.0 \leq I \leq 23$  for high alarm
- $3.5 \leq I \leq 3.75$  for low alarm

Table 2-2. Values for standard and NAMUR operation

Standard Operation (factory default)		NAMUR-Compliant Operation	
Fail High	$21.75 \text{ mA} \leq I \leq 23.0 \text{ mA}$	Fail High	$21 \text{ mA} \leq I \leq 23.0 \text{ mA}$
High Saturation	$I \geq 20.5 \text{ mA}$	High Saturation	$I \geq 20.5 \text{ mA}$
Low Saturation	$I \leq 3.90 \text{ mA}$	Low Saturation	$I \leq 3.8 \text{ mA}$
Fail Low	$I \leq 3.75 \text{ mA}$	Fail Low	$I \leq 3.6 \text{ mA}$

### Simulate Switch (FOUNDATION Fieldbus)

Simulate switch is used to replace the channel value coming from the Sensor Transducer Block. For testing purposes, it manually simulates the output of the Analog Input Block to a desired value.

## MOUNTING

If possible, mount the transmitter at a high point in the conduit run so moisture from the conduits will not drain into the housing. The terminal compartment could fill with water if the transmitter is mounted at a low point in the conduit run. In some instances, the installation of a poured conduit seal, such as the one pictured in Figure 2-3, is advisable. Remove the terminal compartment cover periodically and inspect the transmitter for moisture and corrosion.

Figure 2-2. Incorrect Conduit Installation

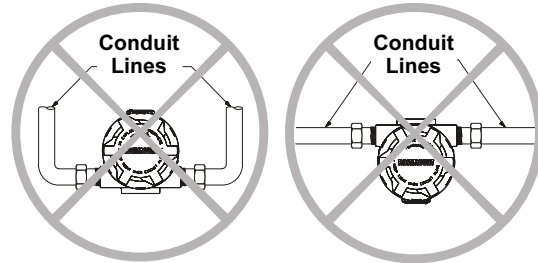

3144-0429A, 0429B

Figure 2-3. Recommended Mounting with Drain Seal

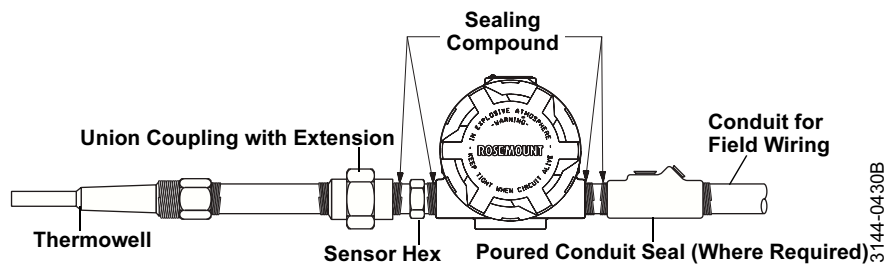

3144-0430B

If mounting the transmitter directly to the sensor assembly, use the process shown in Figure 2-4. If mounting the transmitter apart from the sensor assembly, use conduit between the sensor and transmitter. The transmitter accepts male conduit fittings with 1/2-14 NPT, M20 × 1.5 (CM 20), PG 13.5 (PG 11), or JIS G1/2 threads (M20 × 1.5 (CM 20), PG 13.5 (PG 11), or JIS G1/2 threads are provided by an adapter). Make sure only qualified personnel perform the installation.

The transmitter may require supplementary support under high-vibration conditions, particularly if used with extensive thermowell lagging or long extension fittings. Pipe-stand mounting, using one of the optional mounting brackets, is recommended for use in high-vibration conditions.

## INSTALLATION

### Typical North American Installation

1. Attach the thermowell to the pipe or process container wall. Install and tighten thermowells and sensors. Apply process pressure to perform a leak test.
2. Attach necessary unions, couplings, and extension fittings. Seal the fitting threads with teflon<sup>®</sup> (PTFE) tape (if required).
3. Screw the sensor into the thermowell or directly into the process (depending on installation requirements).
4. Verify all sealing requirements for severe environments or to satisfy code requirements.
5. Attach the transmitter to the thermowell/sensor assembly. Seal all threads with Teflon (PTFE) tape (if required).
6. Pull sensor leads through the extensions, unions, or couplings into the terminal side of the transmitter housing.
7. Install field wiring conduit to the remaining transmitter conduit entry.
8. Pull the field wiring leads into the terminal side of the transmitter housing.
9. Attach the sensor leads to the transmitter sensor terminals. Attach the power leads to the transmitter power terminals.
10. Attach and tighten both transmitter covers. Both transmitter covers must be fully engaged to meet explosion-proof requirements.

Figure 2-4. Typical North American Mounting Configuration.

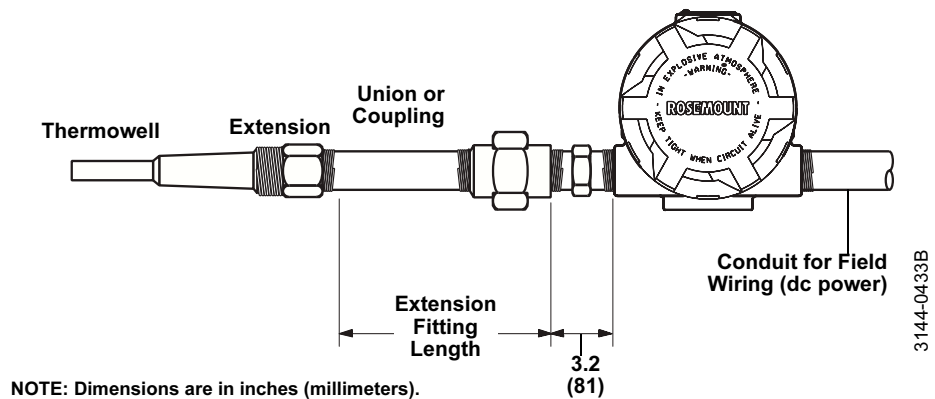

NOTE: Dimensions are in inches (millimeters).

#### NOTE

The National Electrical Code requires that a barrier or seal be used in addition to the primary (sensor) seal to prevent process fluid from entering the electrical conduit and continuing to the control room. Professional safety assistance is recommended for installation in potentially hazardous processes.

**Typical European Installation**

1. Mount the thermowell to the pipe or the process container wall. Install and tighten thermowells and sensors. Apply pressure and perform a leak check before starting the process.
2. Attach a connection head to the thermowell.
3. Insert the sensor into the thermowell and wire it to the connection head. The wiring diagram is located on the inside of the connection head.
4. Mount the transmitter to a 2-inch (50 mm) pipe or a suitable panel using one of the optional mounting brackets. The B4 bracket is shown in Figure 2-5.
5. Attach cable glands to the shielded cable running from the connection head to the transmitter conduit entry.
6. Run the shielded cable from the opposite conduit entry on the transmitter back to the control room.
7. Insert the shielded cable leads through the cable entries into the connection head and the transmitter. Connect and tighten the cable glands.
8. Connect the shielded cable leads to the connection head terminals (located inside of the connection head) and the sensor wiring terminals (located inside of the transmitter housing). Avoid contact with the leads and the terminals.

Figure 2-5. Typical European Process Mounting Configuration.

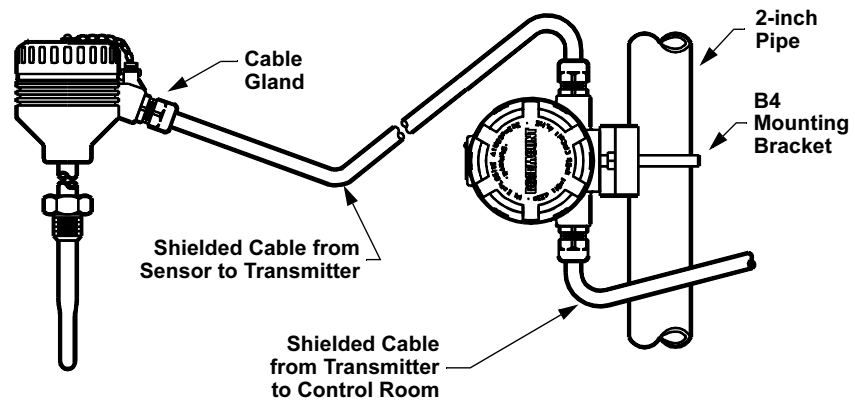

644-0000E05B

## Rosemount 3144P

**In Conjunction with a Rosemount 333 HART Tri-Loop (HART / 4–20 mA only)**

Use the dual-sensor option 3144P transmitter that is operating with two sensors in conjunction with a 333 HART Tri-Loop® HART-to-Analog Signal Converter to acquire an independent 4–20 mA analog output signal for each sensor input. The 3144P transmitter can be configured to output four of the six following digital process variables:

- Sensor 1
- Sensor 2
- Differential temperature
- Average temperature
- First good temperature,
- Transmitter terminal temperature.

The HART Tri-Loop reads the digital signal and outputs any or all of these variables into as many as three separate 4–20 mA analog channels.

Refer to Figure 2-6 for basic installation information. Refer to the 333 HART Tri-Loop HART-to-Analog Signal Converter Reference Manual (document number 00809-0100-4754) for complete installation information.

Figure 2-6. HART Tri-Loop Installation Flowchart<sup>(1)</sup>

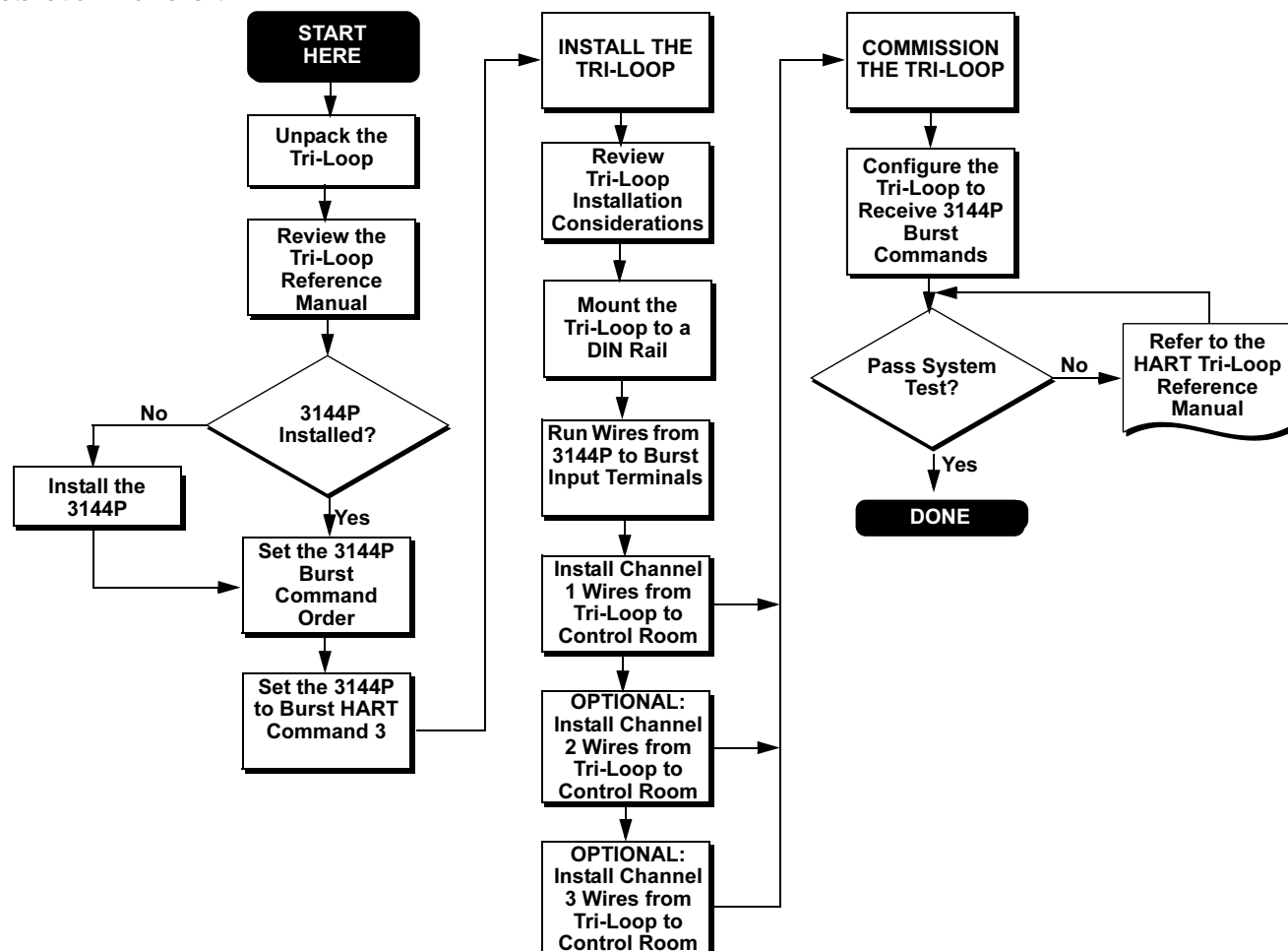



(1) See "Use with the HART Tri-Loop" on page 3-24 for configuration information.

## LCD Display

Transmitters ordered with the LCD display option (code M5) are shipped with the LCD display installed. After-market installation of the LCD display on a conventional 3144P transmitter requires a small instrument screwdriver and the LCD display kit, which includes:

- LCD display assembly
- Extended cover with cover O-ring in place
- Captive screws (quantity 2)
- 10-pin interconnection header

Use the following procedure to install the LCD display. Once the LCD display is installed, configure the transmitter to recognize the meter option. Refer to “LCD Meter Options” on page 3-19 (HART) or “LCD Transducer Block” on page 4-11 (FOUNDATION fieldbus).

1. If the transmitter is installed in a loop, set the loop to manual (HART) / out-of-service (FOUNDATION Fieldbus) mode and disconnect the power.
-  2. Remove the housing cover from the electronics side of the transmitter. Do not remove the transmitter covers in explosive atmospheres if the circuit is live.
3. Ensure that the transmitter write protect switch is set to the **Off** position. If transmitter security is **On**, then you will not be able to configure the transmitter to recognize the LCD display. If security **On** is desired, first configure the transmitter for the LCD display and then install the meter.
4. Insert the interconnection header in the 10-pin socket on the face of the electronics module. Insert the pins into the electronics LCD interface.
5. Orient the meter. The meter can be rotated in 90-degree increments for easy viewing. Position one of the four 10-pin sockets on the back of the meter to accept the interconnection header.
6. Attach the LCD display assembly to the interconnection pins. Thread and tighten the LCD display screws into the holes on the electronics module.
-  7. Attach the extended cover; tighten at least one-third turn after the O-ring contacts the transmitter housing. Both transmitter covers must be fully engaged to meet explosion proof requirements.
8. Apply power and set the loop to automatic (HART) / in-service (FOUNDATION Fieldbus) mode.

---

### NOTE

Observe the following LCD display temperature limits:  
Operating: -4 to 185 °F (-20 to 85 °C)  
Storage: -50 to 185 °F (-45 to 85 °C)

---

## Multichannel Installation (HART / 4–20 mA only)

You can connect several transmitters to a single master power supply (see Figure 2-7). In this case, the system may be grounded only at the negative power supply terminal. In multichannel installations where several transmitters depend on one power supply and the loss of all transmitters would cause operational problems, consider an uninterrupted power supply or a back-up battery. The diodes shown in Figure 2-7 prevent unwanted charging or discharging of the back-up battery.

Figure 2-7. Multichannel Installations.

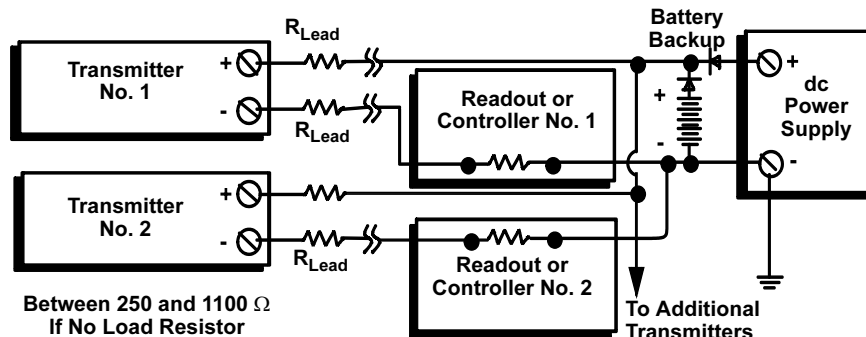

## WIRING

### HART / 4–20 mA

#### Field Wiring

- ⚠ All power to the transmitter is supplied over the signal wiring. Signal wiring does not need to be shielded, but twisted pairs should be used for the best results. Do not run unshielded signal wiring in conduit or open trays with power wiring or near heavy electrical equipment. High voltage may be present on the leads and may cause electrical shock. To wire the transmitter for power, follow the steps below.
- ⚠ 1. Remove the transmitter covers. Do not remove the transmitter covers in an explosive atmosphere when the circuit is live.
- 2. Connect the positive power lead to the terminal marked “+” and the negative power lead to the terminal marked “-” as shown in Figure 2-8. Crimped lugs are recommended when wiring to screw terminals.
- 3. Tighten the terminal screws to ensure that good contact is made. No additional power wiring is required.
- ⚠ 4. Replace the transmitter covers. Both transmitter covers must be fully engaged to meet explosion-proof requirements.

#### NOTE

Do not apply high voltage (e.g., ac line voltage) to the transmitter terminals. Abnormally high voltage can damage the unit.



**Reference Manual**

00809-0100-4021, Rev DA  
November 2004

**Rosemount 3144P**

Figure 2-8. Transmitter Terminal Block

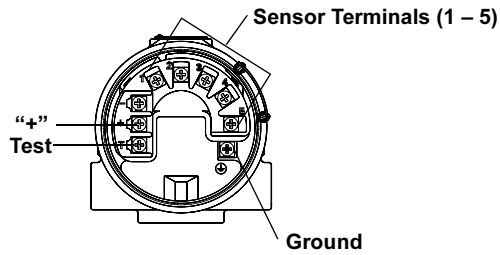
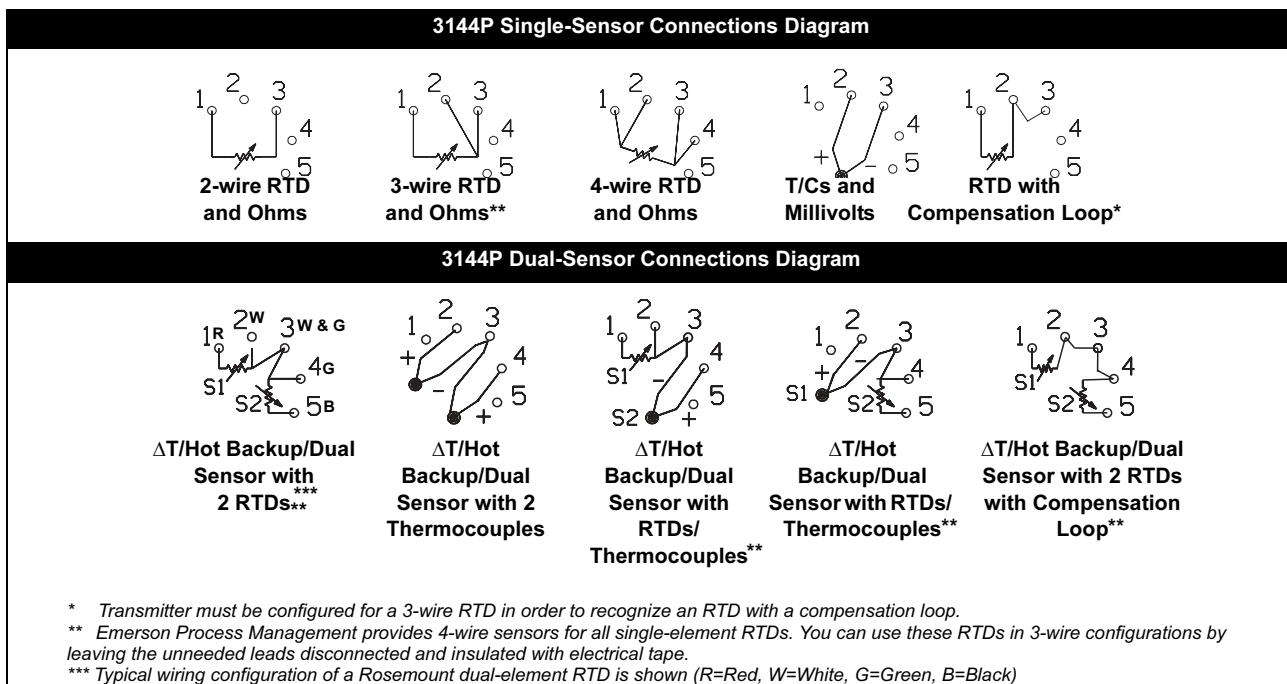

Figure 2-9. HART / 4–20 mA Wiring Diagram



### Power/Current Loop Connections

Use copper wire of a sufficient size to ensure that the voltage across the transmitter power terminals does not go below 12.0 V dc.

1. Connect the current signal leads as shown in Figure 2-10.
2. Recheck the polarity and correctness of connections.
3. Turn the power **ON**.

For information about multichannel installations, refer to page 2-17.

#### NOTE

Do not connect the power/signal wiring to the test terminal. The voltage present on the power/signal leads may burn out the reverse-polarity protection diode that is built into the test terminal. If the test terminal's reverse polarity protection diode is burned out by the incorrect power/signal wiring, the transmitter can still be operated by jumping the current from the test terminal to the “-” terminal. See “Test Terminal” on page 4-3 for use of the terminal.

Figure 2-10. m Connecting a Communicator to a Transmitter Loop (HART/ 4–20 mA).

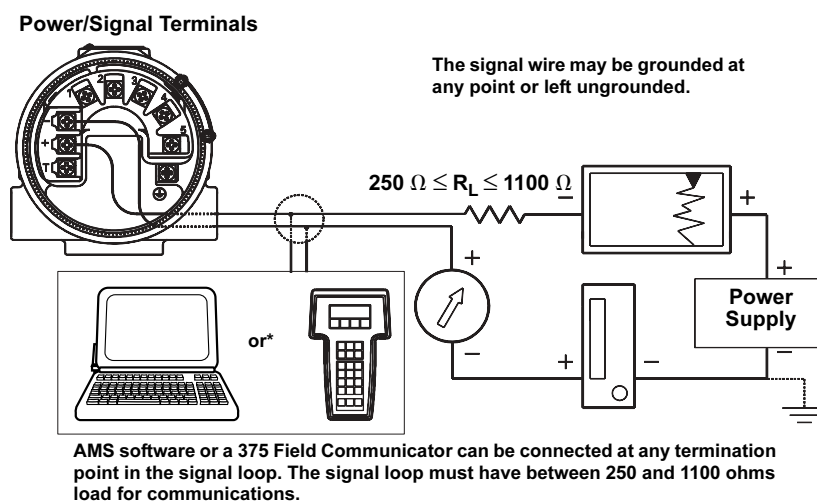

**FOUNDATION Fieldbus**

Figure 2-11. Transmitter Terminal Block

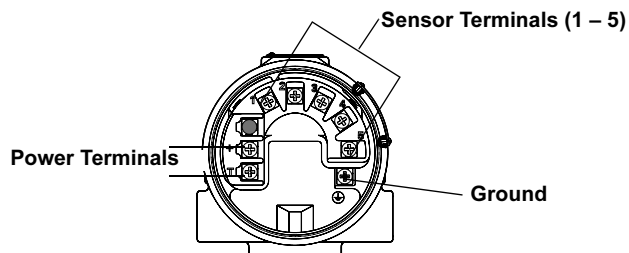
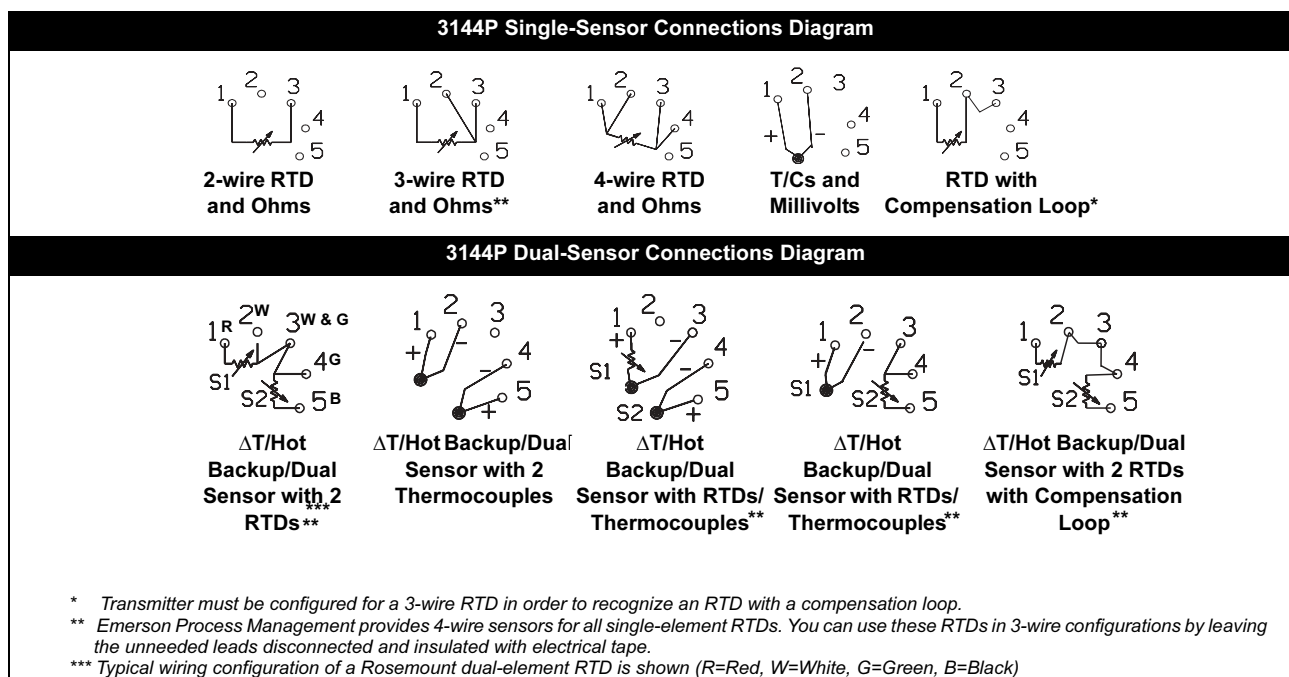



Figure 2-12. FOUNDATION Fieldbus Field Wiring Diagram



## Sensor Connections

 Figure 2-9 on page 2-11 (HART) and Figure 2-12 on page 2-13 (FOUNDATION fieldbus) shows the correct sensor wiring connections to the transmitter sensor terminals. To ensure an adequate sensor connection, anchor the sensor lead wires beneath the flat washer on the terminal screw. Do not remove the transmitter cover in explosive atmospheres if the circuit is live. Both transmitter covers must be fully engaged to meet explosion-proof requirements. Use extreme caution when making contact with the leads and terminals.

### RTD or Ohm Inputs

If the transmitter is mounted remotely from a 3- or 4-wire RTD, it will operate within specifications, without recalibration, for lead wire resistances of up to 10 ohms per lead (equivalent to 1,000 feet of 20 AWG wire). In this case, the leads between the RTD and transmitter should be shielded. If using only two leads (or a compensation loop lead wire configuration), both RTD leads are in series with the sensor element, so significant errors can occur if the lead lengths exceed one foot of 20 AWG wire. For longer runs, attach a third or fourth lead as described above. To eliminate 2-wire lead resistance error, the 2-wire offset command can be used. This allows the user to input the measured lead wire resistance, resulting in the transmitter adjusting the temperature to correct the error.

### Thermocouple or Millivolt Inputs

For direct-mount applications, connect the thermocouple directly to the transmitter. If mounting the transmitter remotely from the sensor, use appropriate thermocouple extension wire. Make connections for millivolt inputs with copper wire. Use shielding for long runs of wire.

---

### NOTE

For HART transmitters, the use of two grounded thermocouples with a dual option 3144P transmitter is not recommended. For applications in which the use of two thermocouples is desired, connect either two ungrounded thermocouples, one grounded and one ungrounded thermocouple, or one dual element thermocouple.

---

## POWER SUPPLY

### HART

An external power supply is required to operate the 3144P (not included). The input voltage range of the transmitter is 12 to 42.4 V DC. This is the power required across the transmitter power terminals. The power terminals are rated to 42.4 V DC. With 250 ohms of resistance in the loop, the transmitter will require a minimum of 18.1 V DC for communication.

The power supplied to the transmitter is determined by the total loop resistance and should not drop below the lift-off voltage. The lift-off voltage is the minimum supply voltage required for any given total loop resistance. See Figure 2-13 to determine the required supply voltage. If the power drops below the lift-off voltage while the transmitter is being configured, the transmitter may output incorrect information.

The dc power supply should provide power with less than 2% ripple. The total resistance load is the sum of the resistance of the signal leads and the load resistance of any controller, indicator, or related piece of equipment in the loop. Note that the resistance of intrinsic safety barriers, if used, must be included.

**NOTE**

Do not allow the voltage to drop below 12.0 V dc at the transmitter terminals when changing transmitter configuration parameters, or permanent damage to the transmitter could result.

Figure 2-13. Load Limits.

$$\text{Maximum Load} = 40.8 \times (\text{Supply Voltage} - 12.0)$$

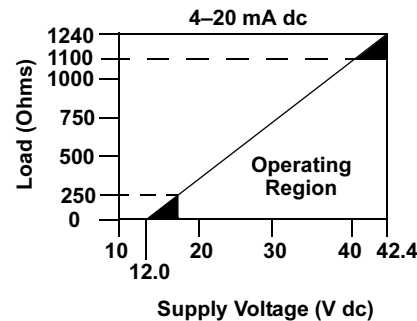

**FOUNDATION fieldbus**

Powered over FOUNDATION fieldbus with standard fieldbus power supplies. The transmitter operates between 9.0 and 32.0 V dc, 11 mA maximum. Transmitter power terminals are rated to 42.4 VDC.

The power terminals on the 3144P with FOUNDATION fieldbus are polarity insensitive.

**Surges/Transients**

The transmitter will withstand electrical transients of the energy level usually encountered in static discharges or induced switching. However, high-energy transients, such as those induced in wiring from nearby lightning strikes, can damage both the transmitter and the sensor.

To protect against high-energy transients, install the integral transient protection board (option code T1). The integral transient protection board is available as an ordered option or as an accessory. Refer to "Transient Protection (Option Code T1)" on page A-16 for more information.

**Grounding**

**Sensor Shielding**

The currents in the leads induced by electromagnetic interference can be reduced by shielding. Shielding carries the current to ground and away from the leads and electronics. If the ends of the shields are adequately grounded, little current will actually enter the transmitter.

If the ends of the shield are left ungrounded, a voltage is created between the shield and the transmitter housing and also between the shield and earth at the element end. The transmitter may not be able to compensate for this voltage, causing it to lose communication and/or go into alarm. Instead of the shield carrying the currents away from the transmitter, the currents will now flow through the sensor leads into the transmitter circuitry where they will interfere with the circuit operation.

### Shielding Recommendations

The following are recommended practices are from API Standard 552 (Transmission Standard) section 20.7 and from field and laboratory testing. If more than one recommendation is given for a sensor type, start with the first technique shown or the technique that is recommended for the facility by its installation drawings. If the technique does not eliminate the transmitter alarms, try another technique. If all techniques unsuccessfully prevent transmitter alarms due to high EMI, contact a Emerson Process Management representative.

#### Ungrounded Thermocouple, mV, and RTD/Ohm Inputs

*Option 1: recommended for ungrounded transmitter housing*

1. Connect the signal wiring shield to the sensor wiring shield.
2. Ensure the two shields are tied together and electrically isolated from the transmitter housing.
3. Ground the shield at the power supply end only.
4. Ensure the shield at the sensor is electrically isolated from the surrounding fixtures that may be grounded.

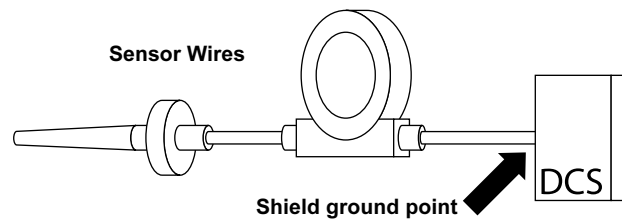

*Connect shields together, electrically isolated from the transmitter*

*Option 2: recommended for grounded transmitter housing*

1. Connect the sensor wiring shield to the transmitter housing, provided the transmitter housing is grounded (see "Transmitter Housing").
2. Ensure the shield at the sensor end is electrically isolated from surrounding fixtures that may be grounded.
3. Ground the signal wiring shield at the power supply end.

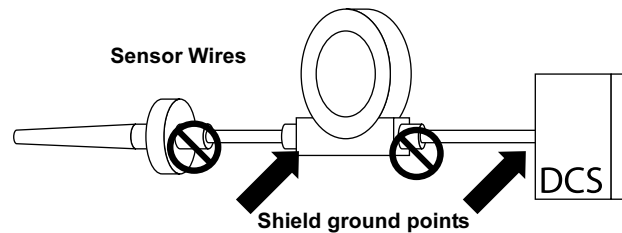

*Option 3*

1. Ground the sensor wiring shield at the sensor, if possible.
2. Ensure the sensor wiring and signal wiring shields are electrically isolated from the transmitter housing and other fixtures that may be grounded.
3. Ground the signal wiring shield at the power supply end.

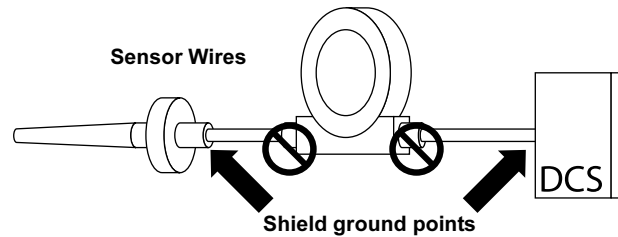

**Grounded Thermocouple Inputs**

1. Ground the sensor wiring shield at the sensor.
2. Ensure the sensor wiring and signal wiring shields are electrically isolated from the transmitter housing and other fixtures that may be grounded.
3. Ground the signal wiring shield at the power supply end.

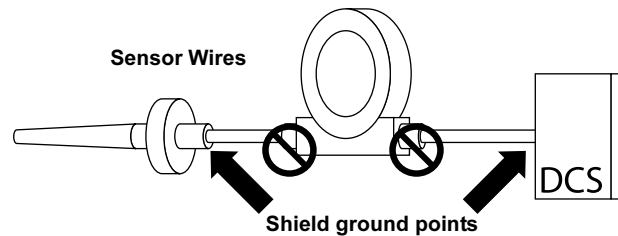

**Transmitter Housing**

Ground the transmitter housing in accordance with local electrical requirements. An internal ground terminal is standard. An optional external ground lug assembly (Option Code G1) can also be ordered if needed. Ordering certain hazardous approvals automatically includes an external ground lug (see Table A-5 on page A-16).





## Section 3 HART Commissioning

Overview .....	page 3-1
Safety Messages .....	page 3-1
375 Field Communicator .....	page 3-2
AMS .....	page 3-5
Review Configuration Data .....	page 3-5
Check Output .....	page 3-6
Configuration .....	page 3-6
Device Output Configuration .....	page 3-14
Device Information .....	page 3-18
Measurement Filtering .....	page 3-19
Diagnostics and Service .....	page 3-21
Multidrop Communication .....	page 3-24
Use with the HART Tri-Loop .....	page 3-25
Calibration .....	page 3-28
Trim the Transmitter .....	page 3-28
Troubleshooting .....	page 3-35

### OVERVIEW

This section contains information on commissioning and tasks that should be performed on the bench prior to installation. This section contains 3144P HART configuration only. 375 Field Communicator and AMS instructions are given to perform configuration functions. For additional information, refer to the HART Communication Reference Manual (document number 00809-0100-4276). AMS help can be found in the AMS on-line guides within the AMS system.

### SAFETY MESSAGES

Instructions and procedures in this section may require special precautions to ensure the safety of the personnel performing the operations. Information that raises potential safety issues is indicated by a warning symbol (⚠). Please refer to the following safety messages before performing an operation preceded by this symbol.

#### ⚠ WARNING

##### Explosions may result in death or serious injury.

- Do not remove the instrument cover in explosive atmospheres when the circuit is live.
- Before connecting a 375 Field Communicator in an explosive atmosphere, make sure the instruments in the loop are installed in accordance with intrinsically safe or non-incendive field wiring practices.
- Both covers must be fully engaged to meet explosion-proof requirements.

##### Electrical shock could cause death or serious injury. If the sensor is installed in a high-voltage environment and a fault or installation error occurs, high voltage may be present on transmitter leads and terminals.

- Use extreme caution when making contact with the leads and terminals.

# Rosemount 3144P

HART

## 375 FIELD COMMUNICATOR

The Menu Tree and Fast Key sequences use the following device revisions:

- Standard 3144P: Device Revision Dev v3, DD v2
- 3144P SIS: Device Revision Dev v2, DD v1

The 375 Field Communicator exchanges information with the transmitter from the control room, the instrument site, or any wiring termination point in the loop. To facilitate communication, connect the Field Communicator in parallel with the transmitter (see Figure 2-10). Use the loop connection ports on the top of the Field Communicator. The connections are non-polarized. Do not make connections to the NiCad recharger jack in explosive atmospheres. Before connecting the Field Communicator in an explosive atmosphere, make sure the instruments in the loop are installed in accordance with intrinsically safe or non-incendive field wiring practices

## Updating the HART Communication Software

The 375 Field Communicator software may need to be updated to take advantage of the additional features available in the 3144P (field device revision 3). Perform the following steps to determine if an upgrade is necessary.

1. Choose "Rosemount" from the list of manufacturers and "3144 Temp" from the list of models.
2. If the **Fid Dev Rev** choices include "Dev v3, DD v2," an upgrade is not required. If the only choice is "Dev v1" or "Dev v2" (with any DD version), then the communicator should be upgraded. The 3144P SIS Safety Certified transmitters requires Device Revision Dev v2, DD v1.

### NOTE

If communication is initiated with an improved 3144P using a communicator that only has a previous version of the transmitter device descriptors (DDs), the communicator will display the following message:

*NOTICE: Upgrade to the 375 software to access new XMTR functions. Continue with old description?*

Select **YES**: the communicator will communicate properly with the transmitter using the existing transmitter DDs. However, new software features of the DD in the communicator will not be accessible. |

Select **NO**: the communicator will default to a generic transmitter functionality.

If **YES** is selected when the transmitter is already configured to utilize the new features of the improved transmitters (such as Dual Input configuration or one of the added sensor input types—DIN Type L or DIN Type U), the user will experience trouble communicating with the transmitter and will be prompted to turn the communicator off. To prevent this from happening, either upgrade the communicator to the latest DD or answer **NO** to the question above and default to the generic transmitter functionality.

To see a list of enhancements included in the improved transmitters, see "Rosemount 3144P and Rosemount 3144 / 3244MV Differences" on page 1-6.

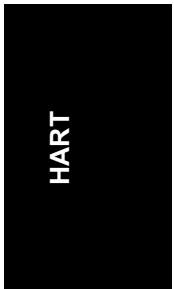

**Menu Tree**

Figure 3-1 displays a complete 3144P menu tree for use with the 375 Field Communicator. Options listed in bold type indicate that a selection provides other options.

For 3144P SIS Safety Certified transmitter, see “3144P SIS Safety Certified Menu Tree” on page 6-4.

Figure 3-1. 3144P Menu Tree

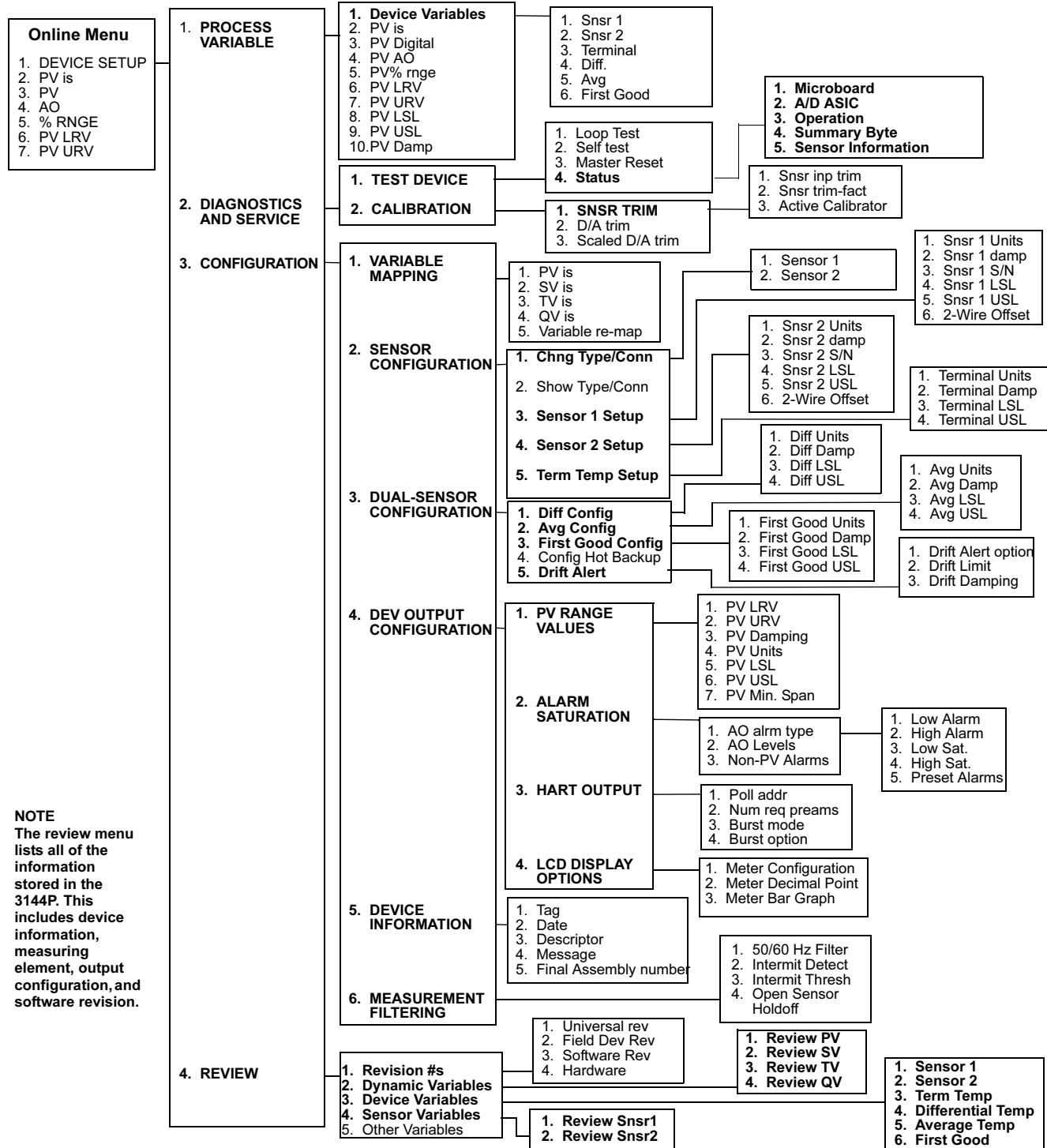

## Rosemount 3144P

## Fast Key Sequences

Fast key sequences are listed below for common 3144P transmitter functions.

**NOTE:**

The fast key sequences assume that “Device Revision Dev v3, DD v2 is being used. Table 3-1 provides alphabetical function lists for all Field Communicator tasks as well as their corresponding fast key sequences.

For 3144P SIS Safety Certified transmitter, see “3144P SIS Fast Key Sequences” on page 6-5.

Table 3-1. Fast Key Sequence

Function	HART Fast Keys	Function	HART Fast Keys
Active Calibrator	1, 2, 2, 1, 3	Open Sensor Holdoff	1, 3, 6, 4
Alarm Values	1, 3, 4, 2, 1	Percent Range	1, 1, 5
Analog Output	1, 1, 4	Poll Address	1, 3, 4, 3, 1
Average Temperature Setup	1, 3, 3, 2	Process Temperature	1, 1
Average Temperature Configuration	1, 3, 3, 2	Process Variables	1, 1
Burst Mode	1, 3, 4, 3, 3	Range Values	1, 3, 4, 1
Burst Option	1, 3, 4, 3, 4	Review	1, 4
Calibration	1, 2, 2	Scaled D/A Trim	1, 2, 2, 3
Configure <i>Hot Backup</i>	1, 3, 3, 4	Sensor 1 Configuration	1, 3, 2, 3
Configuration	1, 3	Sensor 2 Configuration	1, 3, 2, 4
D/A Trim	1, 2, 2, 2	Sensor Limits	1, 3, 2, 2
Damping Values	1, 3, 4, 1, 3	Sensor 1 Serial Number	1, 3, 2, 3, 3
Date	1, 3, 5, 2	Sensor 2 Serial Number	1, 3, 2, 4, 3
Descriptor	1, 3, 5, 3	Sensor 1 Setup	1, 3, 2, 3
Device Information	1, 3, 5	Sensor 2 Setup	1, 3, 2, 4
Diagnostics and Service	1, 2	Sensor Trim	1, 2, 2, 1, 1
Differential Temperature Setup	1, 3, 3, 1	Sensor Type	1, 3, 2, 1
Differential Temperature Configuration	1, 3, 3, 1	Sensor 1 Unit	1, 3, 2, 3, 1
Drift Alert	1, 3, 3, 5	Sensor 2 Unit	1, 3, 2, 4, 1
Filter 50/60 Hz	1, 3, 6, 1	Software Revision	1, 4, 1
First Good Temperature Setup	1, 3, 3, 3	Status	1, 2, 1, 4
First Good Temperature Configuration	1, 3, 3, 3	Tag	1, 3, 5, 1
Hardware Revision	1, 4, 1	Terminal Temperature Setup	1, 3, 2, 5
Hart Output	1, 3, 4, 3	Test Device	1, 2, 1
Intermittent Sensor Detect	1, 3, 6, 2	Transmitter-Sensor Matching	1, 3, 2, 1
Intermittent Threshold	1, 3, 6, 3	URV (Upper Range Value)	1, 3, 4, 1, 2
Loop Test	1, 2, 1, 1	USL (Upper Sensor Limit)	1, 3, 4, 1, 6
LRV (Lower Range Value)	1, 3, 4, 1, 1	Variable Mapping	1, 3, 1
LSL (Lower Sensor Limit)	1, 3, 4, 1, 5	Wires	1, 3, 2, 1
Master Reset	1, 2, 1, 3	2-wire Offset Sensor 1	1, 3, 2, 3, 6
Message	1, 3, 5, 4	2-wire Offset Sensor 2	1, 3, 2, 4, 6
Meter Options	1, 3, 4, 4		

HART

**AMS**

One of the key benefits of intelligent devices is the ease of device configuration. When used with AMS, the 3144P is easy to configure and provides instant and accurate alerts and alarms. The main configuration screen of the 3144P is the “Configuration Properties” screen. From this screen, the transmitter set-up can easily be viewed and edited.

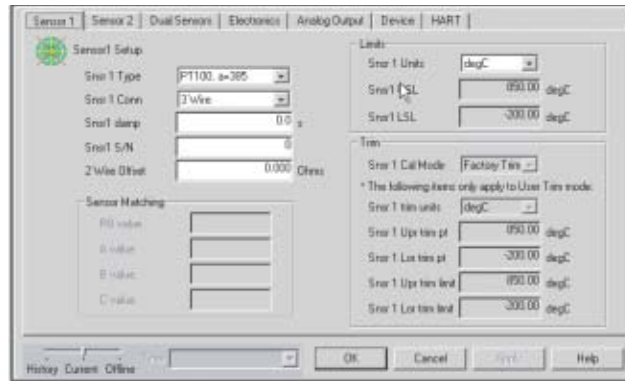

The screens use a color-coding to give visual indication of the transmitter health and to indicate any changes that may need to be made or written to the transmitter.

- Gray screens: indicates that all information has been written to the transmitter
- Yellow on screen: changes have been made in the software but not sent to the transmitter
- Green on screen: all current changes on screen have been written to the transmitter
- Red on screen: indicates an alarm or alert that requires immediate investigation

**Apply AMS Changes**

Changes made in the software must be *sent* to the transmitter in order for the changes to take effect in the process.

1. From the bottom of the “Configuration Properties” screen, click **Apply**.
2. An “Apply Parameter Modification” screen appears, enter desired information and click **OK**.
3. After carefully reading the warning provided, select **OK**.

**REVIEW CONFIGURATION DATA**

Before operating the 3144P in an actual installation, review all of the factory-set configuration data to ensure that it reflects the current application.

**Review**

HART Fast Keys	1, 4
----------------	------

Review the transmitter configuration parameters set at the factory to ensure accuracy and compatibility with the particular application. After activating the *Review* function, scroll through the data list to check each variable. If changes to the transmitter configuration data are necessary, refer to “Configuration” below.

**AMS**

Right click on the device and select “Configuration Properties” from the menu. Select the tabs to review the transmitter configuration data.

## Rosemount 3144P

**CHECK OUTPUT**

Before performing other transmitter online operations, review the configuration of the 3144P digital output parameters to ensure that the transmitter is operating properly.

**Process Variables**

HART Fast Keys	1, 1
----------------	------

The 3144P process variables provide the transmitter output. The PROCESS VARIABLE menu displays the process variables, including sensed temperature, percent range, and analog output. These process variables are continuously updated. The primary variable is 4–20 mA analog signal.

**AMS**

Right click on the device and select “Configuration Properties” from the menu. Select the Analog Output tab to review the transmitter Analog Output Range.

**CONFIGURATION**

The 3144P must be configured for certain basic variables to operate. In many cases, these variables are pre-configured at the factory. Configuration may be required if the configuration variables need revision.

**Variable Mapping**

HART Fast Keys	1, 3, 1
----------------	---------

The Variable Mapping menu displays the sequence of the process variables. Select 5 *Variable Re-Map* to change this configuration. With the 3144P single sensor input configuration, screens follow that allow selection of the primary variable (PV) and the secondary variable (SV). When the *Select PV* screen appears *Snsr 1* or *terminal temperature* must be selected.

With the 3144P dual-sensor option configuration, screens follow that allows selection of the primary variable (PV), secondary variable (SV), tertiary variable (TV), and quaternary variable (QV). Variable choices are *Sensor 1*, *Sensor 2*, *Differential Temperature*, *Average Temperature*, *First-Good Temperature*, *Terminal Temperature*, and *Not Used*. The primary variable is the 4–20 mA analog signal.

**AMS**

Right click on the device and select “Configuration Properties” from the menu. Select the Analog Output tab to review the Mapped Variable Output.

Apply changes made (see “Apply AMS Changes” on page 3-5).

**Sensor Configuration**

HART Fast Keys	1, 3, 2
----------------	---------

Sensor configuration contains information for updating the sensor type, connections, units, and damping.

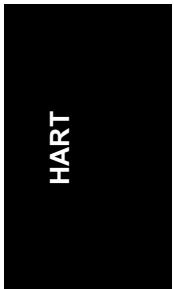

### Change Type and Connections

HART Fast Keys	1, 3, 2, 1
----------------	------------

The *Connections* command allows the user to select the sensor type and the number of sensor wires to be connected. Select from the following sensor types:

- 2-, 3-, or 4-wire Pt 100, Pt 200, Pt 500, Pt 1000 platinum RTDs ( $\alpha = 0.00385 \Omega/\Omega/^\circ\text{C}$ )
- 2-, 3-, or 4-wire Pt 100 ( $\alpha = 0.003916 \Omega/\Omega/^\circ\text{C}$ )
- 2-, 3-, or 4-wire Ni 120 nickel RTDs
- 2-, 3-, or 4-wire Cu 10 RTDs
- IEC/NIST/DIN Type B, E, J, K, R, S, T thermocouples
- DIN type L, U thermocouples
- ASTM Type W5Re/W26Re thermocouple
- -10 to 100 millivolts
- 2-, 3-, or 4-wire 0 to 2000 ohms

Contact a Emerson Process Management representative for information on the temperature sensors, thermowells, and accessory mounting hardware that is available through Emerson Process Management.

#### AMS

Right click on the device and select "Configuration." Select "Sensor Connections," then "Change type and connection." The *wizard* will walk through the screens.

### Output Units

HART Fast Keys	1, 3, 2, 3 or 4
----------------	-----------------

The *Snsr 1 Unit* and *Snsr 2 Unit* commands set the desired primary variable units. Set the transmitter output to one of the following engineering units:

- Degrees Celsius
- Degrees Fahrenheit
- Degrees Rankine
- Kelvin
- Ohms
- Millivolts

#### AMS

Right click on the device and select "Configuration Properties" from the menu. Select the Sensor 1 (or Sensor 2) tab to configure the Sensor Output Units. Set the units to the desired output.

Apply changes made (see "Apply AMS Changes" on page 3-5).

## Rosemount 3144P

**Sensor 1 Serial Number**

HART Fast Keys	1, 3, 2, 3, 3
----------------	---------------

The *Sensor 1 S/N* variable provides a location to list the serial number of the attached sensor. It is useful for identifying sensors and tracking sensor calibration information.

**AMS**

Right click on the device and select “Configuration Properties” from the menu. Select the Sensor 1 tab to configure the Sensor 1 Serial #.

Apply changes made (see “Apply AMS Changes” on page 3-5).

**Sensor 2 Serial Number**

HART Fast Keys	1, 3, 2, 4, 3
----------------	---------------

The *Sensor 2 S/N* variable provides a location to list the serial number of a second sensor.

**AMS**

Right click on the device and select “Configuration Properties” from the menu. Select the Sensor 2 tab to configure the Sensor 2 Serial #.

Apply changes made (see “Apply AMS Changes” on page 3-5).

**2-Wire RTD Offset**

HART Fast Keys	1, 3, 2, 3, 6
----------------	---------------

The *2-wire Offset* command allows the user to input the measured lead wire resistance, which will result in the transmitter adjusting its temperature measurement to correct the error caused by this resistance. Due to a lack of lead wire compensation within the RTD, temperature measurements made with a 2-wire RTD are often inaccurate.

To utilize this feature perform the following steps:

1. Measure the lead wire resistance of both RTD leads after installing the 2-wire RTD and the 3144P.
2. From the HOME screen, select 1 *Device Setup*, 3 *Configuration*, 2 *Sensor Configuration*, 3 *Sensor 1 Setup*, 6 *2-Wire Offset*.
3. Enter the total measured resistance of the two RTD leads at the *2-Wire Offset* prompt. Enter this resistance as a negative (–) value to ensure proper adjustment. The transmitter then adjusts its temperature measurement to correct the error caused by lead wire resistance.
4. Repeat Steps 1 through 3 for sensor 2, selecting 1 *Device Setup*, 3 *Configuration*, 2 *Sensor Configuration*, 4 *Sensor 2 Setup*, 6 *2-Wire Offset*.

**AMS**

Right click on the device and select “Configuration Properties” from the menu. Select the Sensor 1 (or Sensor 2) tab to configure the 2 Wire Offset.

Apply changes made (see “Apply AMS Changes” on page 3-5).



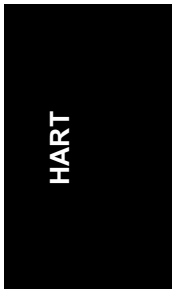

### Terminal Temperature

HART Fast Keys	1, 3, 2, 5
----------------	------------

The *Terminal Temp* command sets the terminal temperature units to indicate the temperature at the transmitter terminals.

#### AMS

Right click on the device and select “Configuration Properties” from the menu. Select the Electronics tab to configure the Terminal Temperature. In the Terminal Temperature box, Set the Terminal Units to the desired output.

Apply changes made (see “Apply AMS Changes” on page 3-5).

### Dual-Sensor Configuration

HART Fast Keys	1, 3, 3
----------------	---------

Dual-sensor configuration allows configuration of the functions that can be used with a dual-sensor configured transmitter. This includes Differential Temperature, Average Temperature, First Good Temperature, Hot Backup, and Sensor Drift Alert.

#### Differential Temperature

HART Fast Keys	1, 3, 1, 5, 3
----------------	---------------

The 3144P configured for a dual-sensor can accept any two inputs and display the differential temperature between them. Use the following procedure to configure the transmitter to measure differential temperature.

First, configure Sensor 1 and Sensor 2 appropriately. Select *1 Device Setup, 3 Configuration, 2 Sensor Configuration, 1 Change type/conn* to set the sensor type and number of wires for Sensor 1. Repeat for Sensor 2.

### NOTE

This procedure reports the differential temperature as the primary variable analog signal. If this is not necessary, assign differential temperature to the secondary, tertiary, or quaternary variable.

1. From the HOME screen, select *1 Device Setup, 3 Configuration, 1 Variable Mapping, 5 Variable Re-Map* to prepare to set the transmitter to display differential temperature. Set the control loop to manual and select **OK**.
2. Select *3 Diff* from the Primary Variable (PV) menu.
3. Select three of the five variables (average temperature, sensor 1, sensor 2, First-Good, and terminal temperature) for the Secondary Variable (SV), Tertiary Variable (TV), and Quaternary Variable (QV).

### NOTE

The transmitter determines the differential temperature by subtracting Sensor 2 from Sensor 1 ( $S1 - S2$ ). Ensure that this order of subtraction is consistent with the desired reading for the application. Refer to Figure 2-12 on page 2-16, or inside the transmitter terminal-side cover for sensor wiring diagrams.

## Rosemount 3144P

HART

4. Select **OK** after verifying the variable settings from the variable mapping menu.
5. Select **OK** to return the control loop to automatic control.
6. Select **HOME** to return to the Online menu.
7. Select *1 Device Setup, 3 Configuration, 3 Dual-sensor configuration, 1 Differential Config, 1 Differential Units* to set the desired differential units.
8. Select **HOME** to return to the Home screen.  
If you are using a LCD display for local indication, configure the meter to read the appropriate variables using the “ LCD Display Options” on page 3-17.

**AMS**

For AMS, configure each sensor as indicated above.

Right click on the device and select “Configuration Properties” from the menu. Select the Dual Sensor tab to configure the Differential Temperature. In the Differential Temperature box, Set the Diff Units to the desired output. Set damping if applicable.

Apply changes made (see “Apply AMS Changes” on page 3-5).

**Average Temperature**

HART Fast Keys	1, 3, 1, 5, 4
----------------	---------------

The 3144P transmitter configured for dual-sensors can output and display the average temperature of any two inputs. Use the following procedure to configure the transmitter to measure the average temperature.

First, configure Sensor 1 and Sensor 2 appropriately. Select *1 Device Setup, 3 Configuration, 2 Sensor Configuration, 1 Change Type and Conn.* to set the sensor type and number of wires for Sensor 1. Repeat for Sensor 2.

**NOTE**

This procedure configures the average temperature as the primary variable analog signal. If this is not necessary, assign the average temperature to the secondary, tertiary, or quaternary variable.

1. From the Home screen, select *1 Device Setup, 3 Configuration, 1 Variable Mapping, 5 Variable Re-map* to set the transmitter to display the average temperature. Set the control loop to manual and select **OK**.
2. Select *4 Sensor Average* from the Primary Variable (PV) menu.
3. Select three of the five variables (differential temperature, sensor 1, sensor 2, First-Good, and terminal temperature) for the Secondary Variable (SV), Tertiary Variable (TV), and Quaternary Variable (QV).
4. Select **OK** after verifying the variable settings in variable mapping menu.
5. Select **OK** to return the control loop to automatic control.
6. Select **HOME** to return to the Online menu.
7. Select *1 Device Setup, 3 Configuration, 3 dual sensor configuration, 2 average, 1 avg units* to set the desired average temperature units.
8. Select **HOME** to return to the Home screen.  
If using a LCD display, configure it to read the appropriate variables using “ LCD Display Options” on page 3-17.

**NOTE**

If Sensor 1 and/or Sensor 2 should fail while PV is configured for average temperature and Hot Backup is **not** enabled, the transmitter will go into alarm. For this reason, when PV is Sensor Average it is recommended that Hot Backup be enabled when dual-element sensors are used or when two temperature measurements are taken from the same point in the process. If a sensor failure occurs when Hot Backup is enabled while PV is Sensor Average, three scenarios could result:

- If Sensor 1 fails, the average will only be reading from Sensor 2, the working sensor.
- If Sensor 2 fails, the average will only be reading from Sensor 1, the working sensor.
- If both sensors fail simultaneously, the transmitter will go into alarm and the status available (via HART) states that both Sensor 1 and Sensor 2 have failed.

In the first two scenarios, where Hot Backup is enabled with PV set to Sensor Average, the 4-20 mA signal is not disrupted and the status available to the control system (via HART) specifies which sensor has failed.

**AMS**

For AMS, configure each sensor as indicated above.

Right click on the device and select “Configuration Properties” from the menu. Select the Dual Sensor tab to configure the Average Temperature. In the Average Temperature box, Set the Ave Units to the desired output. Set damping if applicable.

Apply changes made (see “Apply AMS Changes” on page 3-5).

**First-Good Configuration**

HART Fast Keys	1, 3, 1, 5, 5
----------------	---------------

The *First Good* device variable is useful for applications in which dual-sensors (or a single dual element sensor) are used in a single process. The first good variable will report the Sensor 1 value, unless Sensor 1 fails. When Sensor 1 fails, the Sensor 2 value will be reported as the first good variable. Once the first good variable has switched to Sensor 2, it will not revert back to Sensor 1 until a master reset occurs or “Suspend Non-PV alarms” is disabled. When the PV is mapped to first good and either Sensor 1 or Sensor 2 fails, the analog output will go to the alarm level, but the digital PV value read through the HART interface will still report the proper first good sensor value.

If it is desired that the transmitter not go into analog output alarm while having the PV mapped to first good and Sensor 1 fails, enable “Suspend Non-PV Alarm” mode. This combination will prevent the analog output from going to the alarm level unless BOTH sensors fail.

**AMS**

For AMS, configure each sensor as indicated above.

Right click on the device and select “Configuration Properties” from the menu. Select the Dual Sensor tab to configure the 1st Good. In the 1st Good box, set the 1st Good Units to the desired output. Set damping if applicable.

Apply changes made (see “Apply AMS Changes” on page 3-5).

### Hot Backup Configuration

HART Fast Keys	1, 3, 3, 4
----------------	------------

The *Config Hot BU* command configures the transmitter to automatically use Sensor 2 as the primary sensor if Sensor 1 fails. With Hot Backup enabled, the primary variable (PV) must either be First Good or Sensor Average (see “Average Temperature” on page 3-10 for details on using Hot Backup when PV is Sensor Average). You can map Sensors 1 or 2 as the secondary variable (SV), tertiary variable (TV), or quaternary variable (QV). In the event of a primary variable (Sensor 1) failure, the transmitter enters Hot Backup mode and Sensor 2 becomes the PV. The 4–20 mA signal is not disrupted and a status is available to the control system (via HART) that Sensor 1 has failed. An LCD display, if attached, also displays the failed sensor status.

While configured to Hot Backup, if Sensor 2 fails while Sensor 1 is still operating properly, the transmitter continues to report the PV 4–20 mA analog output signal while a status is available to the control system (via HART) that Sensor 2 has failed. In Hot Backup mode, the transmitter will not revert back to Sensor 1 to control the 4–20 mA analog output until the Hot Backup mode is reset. Reset Hot Backup either by re-enabling via HART or by briefly powering down the transmitter.

To set up and enable the Hot Backup feature for the 3144P transmitter, perform the following procedure:

1. Attach any two sensors to the transmitter as shown in Figure 2-12 on page 2-16.
2. From the Home screen, select *1 Device Setup, 3 Configuration, 1 Variable Mapping, 5 Variable Re-map* to set primary, secondary, tertiary, and quaternary variables. The communicator displays the PV, SV, TV, and QV menus in succession.
3. Set PV as First Good or Sensor Average; set secondary, tertiary, and quaternary variables as desired.
4. Select **OK** after verifying the variable settings from the Variable Mapping menu.
5. Select **OK** to return the control loop to automatic control. Select **HOME** to return to the Home screen.
6. From the Home screen, select *1 Device Setup, 3 Configuration, 2 Sensor Configuration, 1 Change Type and Conn, 3 Sensor 1 Setup* to configure Sensor 1.
7. Set the sensor type, number of wires, damping, and units for Sensor 1.
8. Select **SEND** to download the new data to the transmitter. Select **HOME** to return to the Home screen.
9. Repeat Steps 5, 6, and 7 for Sensor 2 using *4 Sensor 2 Setup*.

10. From the Home screen, select *1 Device Setup, 3 Configuration, 3 Dual Sensor Configuration, 4 Configure Hot Backup* to prepare to configure the transmitter for Hot Backup.
11. Select **yes** to enable *Hot Backup*.
12. Select **OK** after you set the control loop to manual.
13. Select *1 Average* or *2 First Good* to set Hot Backup PV.
14. Select **OK** after you return the control loop to automatic control.

For information on using Hot Backup in conjunction with the HART Tri-Loop see "Use with the HART Tri-Loop" on page 3-25.

#### AMS

For AMS, configure each sensor as indicated above.

Right click on the device and select "Configuration." Select "Configure Hot Backup." The *wizard* will walk through the screens.

#### Drift Alert Configuration

HART Fast Keys	1, 3, 3, 5
----------------	------------

The *Drift Alert* command allows the user to configure the transmitter to set a warning flag (via HART) or go into analog alarm when the temperature difference between Sensor 1 and Sensor 2 exceeds a user-defined limit. This feature is useful when measuring the same process temperature with two sensors, ideally when using a dual-element sensor. When Drift Alert mode is enabled, the user will set the maximum allowable difference, in engineering units, between Sensor 1 and Sensor 2. If this maximum difference is exceeded, a drift alert warning flag will be set.

When configuring the transmitter for Drift Alert the user also has the option of specifying that the analog output of the transmitter go into alarm when sensor drifting is detected.

#### NOTE

For the standard HART product, the Drift Alert alarm cannot be enabled while Hot Backup is enabled. The safety certified transmitter will allow Drift Alert Alarm and Hot Backup configured simultaneously. If one sensor fails the transmitter will switch to the other sensor. If the maximum allowable difference is exceeded the AO will go to alarm with the sensor drift detected. This is considered 1oo2d (one-out-of-two diagnostics) for safety applications. The Drift Alert warning, however, can be used simultaneously with Hot Backup. For information on configuring the transmitter for Hot Backup see page 3-12.

To set up and enable the Drift Alert feature of the 3144P, perform the following procedure:

1. Attach any two sensors to the transmitter as shown in Figure 2-12 on page 2-16.
2. From the Home screen, select *1 Device Setup, 3 Configuration, 1 Variable Mapping, 5 Variable Re-map* to set primary, secondary, tertiary, and quaternary variables. The communicator displays the PV, SV, TV, and QV menus in succession.
3. Select primary, secondary, tertiary, and quaternary variables as desired.
4. Select **OK** after verifying the variable settings from the Variable Mapping menu.

## Rosemount 3144P

HART

5. Select **OK** to return the control loop to automatic control. Select **HOME** to return to the Home screen.
6. From the Home screen, select *1 Device Setup, 3 Configuration, 2 Sensor Configuration, 1 Change Type and Conn, 3 Sensor 1 Setup* to configure Sensor 1.
7. Set the sensor type, number of wires, damping, and units for Sensor 1.
8. Select **SEND** to download the new data to the transmitter. Select **HOME** to return to the Home screen.
9. Repeat steps 6 – 8 for Sensor 2 using *4 Sensor 2 setup*.
10. From the Home screen select *1 Device Setup, 3 Configuration, 3 Dual-Sensor Configuration, 5 Drift Alert* to prepare to configure the transmitter for Drift Alert.
11. Select *2 Drift Limit*. Enter the maximum acceptable difference between Sensor 1 and Sensor 2.
12. Select *3 Drift Damping* to enter a drift alert damping value. This value must be between 0 and 32 seconds.
13. Select *1 Drift Alert Option* and select *Enable Alarm or Warning* only.
14. Select **SEND** to download the alarm setting to the transmitters.

**NOTE**

Enabling Drift Alert Option Warning only (Step 13) will set a flag (via HART) whenever the maximum acceptable difference between Sensor 1 and Sensor 2 has been exceeded. If it is desired for the transmitter's analog signal to go into alarm when Drift Alert is detected, select **Alarm** in Step 13.

**AMS**

For AMS, configure each sensor as indicated above.

Right click on the device and select "Configuration Properties" from the menu. Select the Dual Sensor tab to configure the Sensor Drift Alarm. In the Drift Alert box, enable the Drift Alert Option. Enter the DrftLm limit and define the Drift Limit Units. Set damping if applicable.

Apply changes made (see "Apply AMS Changes" on page 3-5).

**DEVICE OUTPUT CONFIGURATION**

Device output configuration contains PV range values, alarm and saturation, HART output, and LCD display options.

**PV Range Values**

HART Fast Keys	1, 3, 4, 1
----------------	------------

The *PV URV* and *PV LRV* commands, found in the *PV Range Values* menu screen, allow the user to set the transmitter's lower and upper range values using limits of expected readings. See Table A-2 on page A-5 for unit and range setting limits. The range of expected readings is defined by the Lower Range Value (LRV) and Upper Range Value (URV). The transmitter range values may be reset as often as necessary to reflect changing process conditions. From the *PV Range Values* screen select *1 PV LRV* to change the lower range value and *2 PV URV* to change the upper range value.

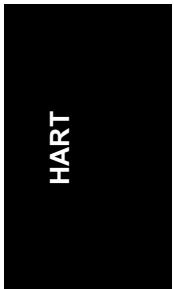

Reranging the transmitter sets the measurement range to the limits of the expected readings. Setting the measurement range to these limits maximizes transmitter performance; the transmitter is most accurate when operated within the expected temperature range for the application.

The rerange functions should not be confused with the trim function. Although reranging the transmitter matches a sensor input to a 4-20 mA output, as in conventional calibration, it does not affect the transmitter's interpretation of the input.

#### AMS

Right click on the device and select "Configuration Properties" from the menu. Select the Analog Output tab to define the upper and lower range values. From the Analog Input Range box, enter the URV and LRV.

Apply changes made (see "Apply AMS Changes" on page 3-5).

#### Process Variable Damping

HART Fast Keys	1, 3, 4, 1, 3
----------------	---------------

The *PV Damp* command changes the response time of the transmitter to smooth variations in output readings caused by rapid changes in input. Determine the appropriate damping setting based on the necessary response time, signal stability, and other requirements of the loop dynamics of the system. The default damping value is 5.0 seconds and can be reset to any value between 0 and 32 seconds.

The value chosen for damping affects the response time of the transmitter. When set to zero (i.e., disabled), the damping function is off and the transmitter output reacts to changes in input as quickly as the intermittent sensor algorithm allows. Increasing the damping value increases transmitter response time.

When damping is enabled, the transmitter will output a value at time (t) according to the following equation:

$$\text{Output}_{(t)} = \text{Input}_{(ts)} - De^{(-t/\text{damping})}$$

D = input step change at time t = 0

At the time to which the damping time constant is set, the transmitter output is at 63 percent of the input change; it continues to approach the input according to the damping equation above.

For example, as illustrated in Figure 3-2, if the temperature undergoes a step change—from 100 degrees to 110 degrees, and the damping is set to 5.0 seconds, at 5.0 seconds, the transmitter outputs 106.3 degrees, or 63 percent of the input change, and the output continues to approach the input curve according to the equation above.

## Rosemount 3144P

HART

Figure 3-2. Change in Input versus Change in Output with Damping Enabled.

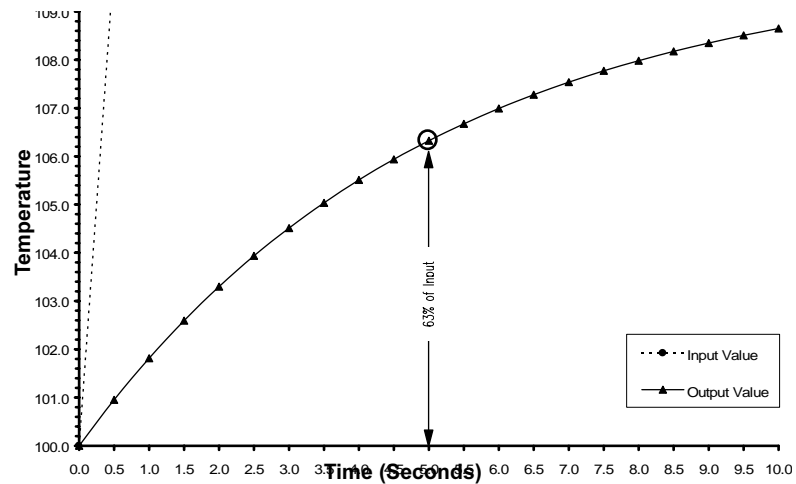
**AMS**

Right click on the device and select “Configuration Properties” from the menu. If Sensor 1 is mapped as your primary variable, select the Sensor 1 tab.

- Snr1 damp

Apply changes made (see “Apply AMS Changes” on page 3-5).

**Alarm and Saturation**

HART Fast Keys	1, 3, 4, 2
----------------	------------

The *Alarm/Saturation* command allows the user to view the alarm settings (Hi or Low). With this command it is also possible to change the alarm and saturation values. To change the alarm values and saturation values, select the value to be changed, either *1 Low Alarm*, *2 High Alarm*, *3 Low Sat.*, *4 High Sat.*, or *5 Preset Alarms*. Enter the desired new value. It must fall within the guidelines given below.

- The low alarm value must be between 3.50 and 3.75 mA
- The high alarm value must be between 21.0 and 23.0 mA

The low saturation level must be between the low alarm value plus 0.1 mA and 3.9 mA for the standard HART transmitter. For the safety certified transmitter the lowest saturation setting is 3.7 mA and the highest is 20.9 mA.

Example: The low alarm value has been set to 3.7 mA. Therefore, the low saturation level, S, must be as follows:

$$3.8 \leq S \leq 3.9 \text{ mA.}$$

The high saturation level must be between 20.5 mA and the high alarm value minus 0.1 mA for the standard HART transmitter. The highest saturation setting for the Safety Certified transmitter is 20.9 mA.



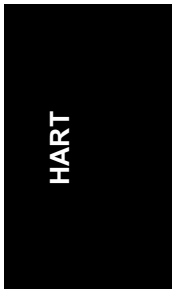

**Example:** The high alarm value has been set to 20.8 mA. Therefore, the low saturation level, S, must be as follows:  
 $20.5 \leq S \leq 20.7$  mA.

Preset alarms can either be *1 Rosemount* or *2 NAMUR-compliant*. Use the failure mode switch on the front side of the electronics (see “Switch Location” on page A-7) to set whether the output will be driven to high or low alarm in the case of failure.

#### AMS

For AMS, configure each sensor as indicated above.

Right click on the device and select “Configuration Properties” from the menu. Select the Analog Output tab to define the alarm and saturation levels. From the Alarm box, enter the low and high alarm and the low and high saturation.

Apply changes made (see “Apply AMS Changes” on page 3-5).

To preset to Rosemount standard or NAMUR NE43 compliant levels:

Right-click on the device and select “Configuration.” Select “Alarm Configuration” then select “Alarm Configuration” then “Preset alarm levels.” The *wizard* will walk through the configuration.

#### HART Output

HART Fast Keys	1, 3, 4, 3
----------------	------------

The *HART Output* command allows the user to make changes to the multidrop address, initiate burst mode, or make changes to the burst options.

#### AMS

Right click on the device and select “Configuration Properties” from the menu. Select the HART tab to configure for multidrop and Burst Mode.

Apply changes made (see “Apply AMS Changes” on page 3-5).

#### LCD Display Options

HART Fast Keys	1, 3, 4, 4
----------------	------------

The *LCD Display Option* command sets the meter options, including engineering units and decimal point. Change the LCD display settings to reflect necessary configuration parameters when adding a LCD display or reconfiguring the transmitter. Transmitters without LCD displays are shipped with the meter configuration set to “Not Used.”

To customize variables that the LCD display displays, follow the steps below:

1. From the home screen select *1 Device Setup, 3 Configuration, 4 Dev Output Config, 4 LCD Display Options, and 1 Meter Config.*
2. Select the appropriate variable configuration from the Meter Configuration screen.
3. Press F4, **ENTER**, and then F2, **SEND**, to send the information to the transmitter. The LCD display will scroll through the outputs selected in step 2.

To change the decimal point configuration, perform the following steps:

1. From the home screen select *1 Device Setup, 3 Configuration, 4 Dev Output Config, 4 LCD Display Options, and 2 Meter Decimal Pt.*

## Rosemount 3144P

HART

2. Choose from *Floating Precision* or *One-, Two-, Three-, or Four-Digit Precision* by pressing F4, **ENTER**. Press F2 to send the information to the transmitter.

To change the meter bar graph, perform the following steps:

1. From the home screen, select *1 Device Setup, 3 Configuration, 4 Dev Output Configuration, 4 LCD Display options, 3 Meter bar graph*.
2. Choose from *Bar Graph offer, Bar graph on* by pressing F4, Enter. Press F2 to send the information to the transmitter.

**AMS**

Right click on the device and select "Configuration Properties" from the menu. Select the Device tab to configure the LCD. From the LCD Display box, define the Meter Config, Meter Decimal Pt, and Meter Bar Graph.

Apply changes made (see "Apply AMS Changes" on page 3-5).

**DEVICE INFORMATION**

Access the transmitter information variables online using the Field Communicator or other suitable communications device. The following is a list of transmitter information variables. These variables include device identifiers, factory-set configuration variables, and other information. A description of each variable, the corresponding fast key sequence, and a review of its purposes are provided.

**Tag**

HART Fast Keys	1, 3, 5, 1
----------------	------------

The *Tag* variable is the easiest way to identify and distinguish between transmitters in multi-transmitter environments. Use it to label transmitters electronically according to the requirements of the application. The defined tag is automatically displayed when a HART-based communicator establishes contact with the transmitter at power-up. The tag may be up to eight characters long and has no impact on the primary variable readings of the transmitter.

**Date**

HART Fast Keys	1, 3, 5, 2
----------------	------------

The *Date* command is a user-defined variable that provides a place to save the date of the last revision of configuration information. It has no impact on the operation of the transmitter or the HART-based communicator.

**Descriptor**

HART Fast Keys	1, 3, 5, 3
----------------	------------

The *Descriptor* variable provides a longer user-defined electronic label to assist with more specific transmitter identification than is available with the tag variable. The descriptor may be up to 16 characters long and has no impact on the operation of the transmitter or the HART-based communicator.

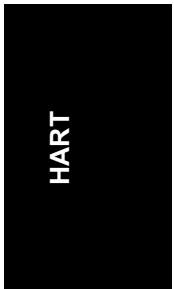

**Message**

HART Fast Keys	1, 3, 5, 4
----------------	------------

The *Message* variable provides the most specific user-defined means for identifying individual transmitters in multi-transmitter environments. It allows for 32 characters of information and is stored with the other configuration data. The message variable has no impact on the operation of the transmitter or the HART-based communicator.

**AMS**

Right click on the device and select "Configuration Properties" from the menu. Select the Device tab to enter alphanumeric device information.

Apply changes made (see "Apply AMS Changes" on page 3-5).

**MEASUREMENT  
FILTERING**

**50/60 Hz Filter**

HART Fast Keys	1, 3, 6, 1
----------------	------------

The *50/60 Hz Filter* command sets the transmitter electronic filter to reject the frequency of the ac power supply in the plant. The 60 Hz normal, 50 Hz normal, 60 Hz fast, and 50 Hz fast modes can be chosen (normal mode is the default mode). On software release 5.3.4, the fast mode cannot be enabled. If fast mode is selected it will display the normal mode.

**NOTE**

In high noise environments, normal mode is recommended.

**Master Reset**

HART Fast Keys	1, 2, 1, 3
----------------	------------

*Master Reset* resets the electronics without actually powering down the unit. It does not return the transmitter to the original factory configuration.

**AMS**

Right click on the device and select "Diagnostics and Calibration" from the menu. Choose "test," then "Master Reset."

The *wizard* will perform the reset

**Intermittent Sensor Detect**

HART Fast Keys	1, 3, 6, 2
----------------	------------

The following steps indicate how to turn the Intermittent Sensor Detect feature **ON** or **OFF**. When the transmitter is connected to a Field Communicator, use the fast key sequence and choose **ON** or **OFF** (**ON** is the normal setting).

**AMS**

Right click on the device and select "Configuration Properties" from the menu. Select the Electronics tab. From the Measurement Filtering Box, configure the Intermit detect.

The *wizard* will perform the reset

Apply changes made (see "Apply AMS Changes" on page 3-5).

## Rosemount 3144P

HART

**Intermittent Threshold**

HART Fast Keys	1, 3, 6, 3
----------------	------------

The threshold value can be changed from the default value of 0.2%. Turning the Intermittent Sensor Detect feature **OFF** or leaving it **ON** and increasing the threshold value above the default does not affect the time needed for the transmitter to output the correct alarm signal after detecting a true open sensor condition. However, the transmitter may briefly output a false temperature reading for up to one update in either direction (see Figure 3-4 on page 3-24) up to the threshold value (100% of sensor limits if Intermittent Sensor Detect is **OFF**). Unless rapid response rate is necessary, the suggested setting of the Intermittent Sensor Detect mechanism is **ON** with 0.2% threshold.

Figure 3-3. Open Sensor Response

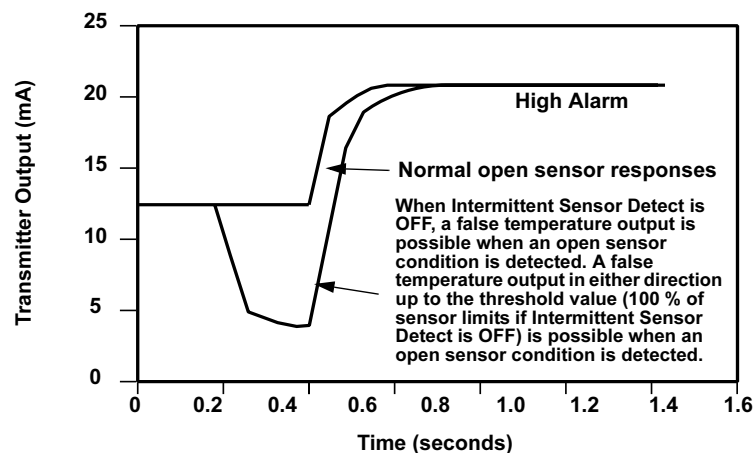

644-644\_03

**Intermittent Sensor Detect (Advanced Feature)**

The Intermittent Sensor Detect feature is designed to guard against process temperature readings caused by intermittent open sensor conditions (an *intermittent* sensor condition is an open sensor condition that lasts less than one update). By default, the transmitter is shipped with the Intermittent Sensor Detect feature switched **ON** and the threshold value set at 0.2% of sensor limits. The Intermittent Sensor Detect feature can be switched **ON** or **OFF** and the threshold value can be changed to any value between 0 and 100% of the sensor limits with a Field Communicator.

**Transmitter Behavior with Intermittent Sensor Detect ON**

When the Intermittent Sensor Detect feature is switched **ON**, the transmitter can eliminate the output pulse caused by intermittent open sensor conditions. Process temperature changes ( $\Delta T$ ) within the threshold value will be tracked normally by the transmitter's output. A  $\Delta T$  greater than the threshold value will activate the intermittent sensor algorithm. True open sensor conditions will cause the transmitter to go into alarm.

The threshold value of the 3144P should be set at a level that allows the normal range of process temperature fluctuations; too high and the algorithm will not be able to filter out intermittent conditions; too low and the algorithm will be activated unnecessarily. The default threshold value is 0.2% of the sensor limits.

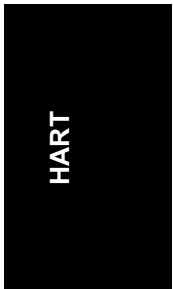

### Transmitter Behavior with Intermittent Sensor Detect OFF

When the Intermittent Sensor Detect feature is switched **OFF**, the transmitter tracks all process temperature changes, even if they are the consequence of an intermittent sensor. (The transmitter in effect behaves as though the threshold value had been set at 100%.) The output delay due to the intermittent sensor algorithm will be eliminated.

#### AMS

Right click on the device and select "Configuration Properties" from the menu. Select the Electronics tab. From the Measurement Filtering Box, configure the Intermit threshold.

Apply changes made (see "Apply AMS Changes" on page 3-5).

### Open Sensor Holdoff

HART Fast Keys	1, 3, 6, 4
----------------	------------

The *Open Sensor Holdoff* option, at the normal setting, enables the 3144P to be more robust under heavy EMI conditions. This is accomplished through the software by having the transmitter perform additional verification of the open sensor status prior to activating the transmitter alarm. If the additional verification shows that the open sensor condition is not valid, the transmitter will not go into alarm.

For users of the 3144P that desire a more vigorous open sensor detection, the Open Sensor Holdoff option can be changed to a fast setting. With this setting, the transmitter will report an open sensor condition without additional verification of the open condition.

#### AMS

Right click on the device and select "Configuration Properties" from the menu. Select the Electronics tab. From the Measurement Filtering Box box, configure the Open Snsr Holdoff.

Apply changes made (see "Apply AMS Changes" on page 3-5).

## DIAGNOSTICS AND SERVICE

### Test Device

HART Fast Keys	1, 2, 1
----------------	---------

The *Test Device* command initiates a more extensive diagnostics routine than that performed continuously by the transmitter. The *Test Device* menu lists the following options:

- *1 Loop test* verifies the output of the transmitter, the integrity of the loop, and the operations of any recorders or similar devices installed in the loop. The ability to simulate an alarm is also available. See "Loop Test" below for more information.
- *2 Self Test* initiates a transmitter self test. Error codes are displayed if there is a problem.
- *3 Master Reset* sends out a command that restarts and tests the transmitter. A master reset is like briefly powering down the transmitter. Configuration data remains unchanged after a master reset.
- *4 Status* lists error codes. **ON** indicates a problem, and **OFF** means there are no problems.

# Rosemount 3144P

---

HART

## **AMS**

Right click and select "Diagnostics and Calibration." Choose "Test" and select "loop test," "self test," or "master reset." Right-click on device and choose "status" to view errors.

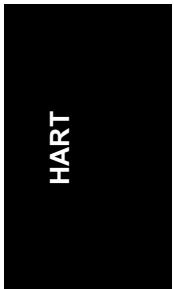

### Loop Test

HART Fast Keys	1, 2, 1, 1
----------------	------------

The Loop Test command verifies the output of the transmitter, the integrity of the loop, and the operations of any recorders or similar devices installed in the loop. To initiate a loop test, perform the following procedure:

1. Connect an external ampere meter to the transmitter. To do so, shunt the power to the transmitter through the meter at some point in the loop.
2. From the **HOME** screen, select *1 Device Setup, 2 Diag/Serv, 1 Test Device, 1 Loop Test* before performing a loop test. Select **OK** after you set the control loop to manual. The communicator displays the loop test menu.
3. Select a discreet milliamperage level for the transmitter to output. At the **CHOOSE ANALOG OUTPUT** prompt, select *1 4mA, 2 20mA*, or select *4 Other* to manually input a value between 4 and 20 milliamperes. Select **Enter**. It will indicate the fixed output. Select **OK**.
4. Check the installed transmitter in the test loop to verify that it reads the value that it was commanded to output. If the readings do not match, either the transmitter requires an output trim or the current meter is malfunctioning.

After completing the test procedure, the display returns to the loop test screen and allows the user to choose another output value. To end the Loop Test, Select *5 End* and **Enter**. The Test device screen will appear.

The transmitter can simulate alarm conditions based on the transmitter's current hardware and software alarm configurations.

To initiate Simulation Alarm, perform the following procedure:

1. From the Home screen, select *1 Device Setup, 2 Diag/Serv, 1 Test Device, 1 Loop Test, 3 Simulate Alarm*.
2. Based on the chosen alarm conditions, the transmitter will display an alarm.
3. To return the transmitter to normal conditions, select *5 End*.

### AMS

Right click and select "Diagnostics and Calibration." Choose "Test" and select "Loop Test." The *loop test wizard* will walk through the process to fix the output for either sensor 1 or 2.

The transmitter must be returned to normal conditions (turn off loop test) before placing back in process

Right click and select "Diagnostics and Calibration." Choose "Test" and select "Loop Test." The *loop test wizard* will walk through the process to fix the analog output. From the *loop test wizard* screen choose "END." A message will appear indicating that it is OK to return to normal.

## Rosemount 3144P

HART

**MULTIDROP  
COMMUNICATION**

*Multidropping* refers to the connection of several transmitters to a single communications transmission line. Communication between the host and the transmitters takes place digitally with the analog output of the transmitters deactivated. Many of Rosemount transmitters can be multidropped. With the HART communications protocol, up to 15 transmitters can be connected on a single twisted pair of wires or over leased phone lines.

The application of a multidrop installation requires consideration of the update rate necessary from each transmitter, the combination of transmitter models, and the length of the transmission line. Each transmitter is identified by a unique address (1–15) and responds to the commands defined in the HART protocol.

Figure 3-4. Typical Multidropped Network

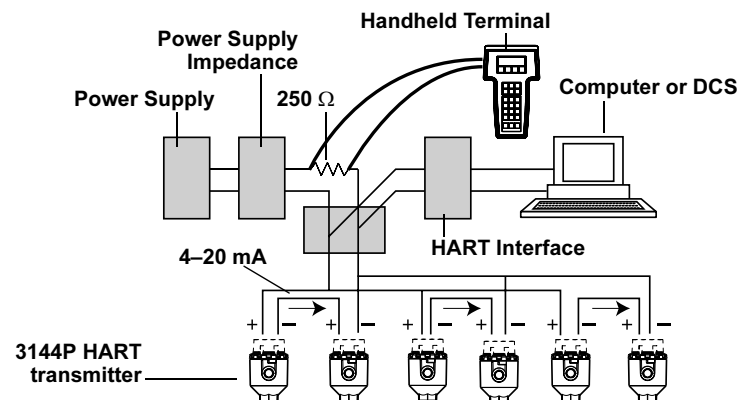

Figure 3-4 shows a typical multidrop network. Do not use this figure as an installation diagram. Contact Emerson Process Management product support with specific requirements for multidrop applications.

A HART-based communicator can test, configure, and format a multidropped 3144P transmitter the same as in a standard point-to-point installation.

**NOTE**

The 3144P is set to address 0 at the factory, allowing it to operate in the standard point-to-point manner with a 4–20 mA output signal. To activate multidrop communication, the transmitter address must be changed to a number between 1 and 15. This change deactivates the 4–20 mA analog output, sending it to 4 mA. The failure mode current also is disabled.

**AMS**

Right click and select “Configuration Properties” from the menu screen. Select the “HART” tab. From here, assign the polling address.



## USE WITH THE HART TRI-LOOP

To prepare the 3144P transmitter with dual-sensor option for use with a Rosemount 333 HART Tri-Loop, you must configure the transmitter to Burst Mode and set the process variable output order. In Burst Mode, the transmitter provides digital information for the four process variables to the HART Tri-Loop. The HART Tri-Loop divides the signal into separate 4–20 mA loops for up to three of the following choices:

- primary variable (PV)
- secondary variable (SV)
- tertiary variable (TV)
- quaternary variable (QV)

When using the 3144P transmitter with dual-sensor option in conjunction with the HART Tri-Loop, consider the configuration of the differential, average, first good temperatures, Sensor Drift Alarm, and Hot Backup features (if applicable).

### NOTE

These procedures assume that the sensors and the transmitter are connected, powered, and functioning properly, and that a Field Communicator is connected to the transmitter control loop and is communicating successfully. For communicator usage instructions, see “Commissioning” on page 2-2.

### Set the Transmitter to Burst Mode

To set the transmitter to burst mode, follow the steps below.

1. From the Home screen, select *1 Device setup, 3 Configuration, 4 Device output configuration, 3 HART output, 4 Burst option* to prepare to set the transmitter to burst command 3. The communicator displays the Burst option screen.
2. Select *Process vars/current*. The communicator returns to the HART output screen.
3. Select *3 Burst mode* to prepare to enable Burst Mode. The communicator displays the Burst Mode screen.
4. Select **On** to enable Burst Mode. The communicator returns to the HART output screen.
5. Select **Send** to download the new configuration information to the transmitter.

### Set Process Variable Output Order

To set the process variable output order, follow the steps below.

1. From the Home screen, select *1 Device setup, 3 Configuration, 1 Variable Mapping, 5 Variable Remapping*. Select **OK** to set the control loop to manual. The communicator displays the Primary Variable screen.
2. Select the item to be set as the primary variable at the **Select PV** prompt.
3. Repeat step 2 for the SV, TV, and QV. The communicator displays the Variable mapping screen.
4. Select **OK** to accept the order to which the variables are mapped, or **Abort** to abort the entire procedure.

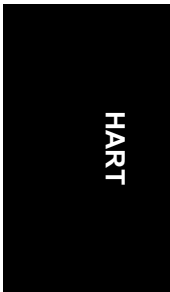

**NOTE**

Take careful note of the process variable output order. You must configure the HART Tri-Loop to read the variables in the same order.

5. Select **OK** to return the control loop to automatic control.

**AMS**

Right click and select “Configuration” from the menu screen. Select “Set Variable Mapping”. The “*Set Variable Mapping wizard*” will go through the mapping procedure.

**Special Considerations**

To initiate operation between a 3144P transmitter with dual-sensor option and the HART Tri-Loop, consider the configuration of both the differential, average, first good temperatures, Sensor Drift Alarm, and Hot Backup features (if applicable).

**Differential Temperature Measurement**

To enable the differential temperature measurement feature of a dual-sensor 3144P operating in conjunction with the HART Tri-Loop, adjust the range end points of the corresponding channel on the HART Tri-Loop to include zero. For example, if the secondary variable of the transmitter is to report the differential temperature, configure the transmitter accordingly (see “Set Process Variable Output Order” on page 3-25) and adjust the corresponding channel of the HART Tri-Loop so one range end point is negative and the other is positive.

**Hot Backup**

To enable the Hot Backup feature of a 3144P transmitter with dual-sensor option operating in conjunction with the HART Tri-Loop, ensure that the output units of the sensors are the same as the units of the HART Tri-Loop. Use any combination of RTDs or thermocouples as long as the units of both match the units of the HART Tri-Loop.

**Using the Tri-Loop to Detect Sensor Drift Alarm**

The dual-sensor 3144P transmitter sets a failure flag (via HART) whenever a sensor failure occurs. If an analog warning is required, the HART Tri-Loop can be configured to produce an analog signal that can be interpreted by the control system as a sensor failure.

Use these steps to set up the HART Tri-Loop to transmit sensor failure alerts.

1. Configure the dual-sensor 3144P variable map as shown.

Variable	Mapping
PV	Sensor 1 or Sensor Average
SV	Sensor 2
TV	Differential Temperature
QV	As Desired

2. Configure Channel 1 of the HART Tri-Loop as TV (differential temperature). If either sensor should fail, the differential temperature output will be +9999 or -9999 (high or low saturation), depending on the position of the Failure Mode Switch (see “Failure Mode and Security Switch Locations” on page 2-5).

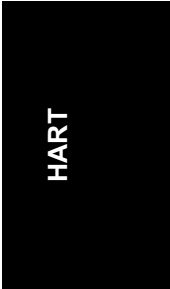

3. Select temperature units for Channel 1 that match the differential temperature units of the transmitter.
4. Specify a range for the TV such as  $-100$  to  $100$  °C. If the range is large, then a sensor drift of a few degrees will represent only a small percent of range. If Sensor 1 or Sensor 2 fails, the TV will be +9999 (high saturation) or -9999 (low saturation). In this example, zero is the midpoint of the TV range. If a  $\Delta T$  of zero is set as the lower range limit (4 mA), then the output could saturate low if the reading from Sensor 2 exceeds the reading from Sensor 1. By placing zero in the middle of the range, the output will normally stay near 12 mA, and the problem will be avoided.
5. Configure the DCS so that  $TV < -100$  °C or  $TV > 100$  °C indicates a sensor failure and, for example,  $TV \leq -3$  °C or  $TV \geq 3$  °C indicates a drift alert. See Figure 3-5.

Figure 3-5. Tracking Sensor Drift and Sensor Failure with Differential Temperature

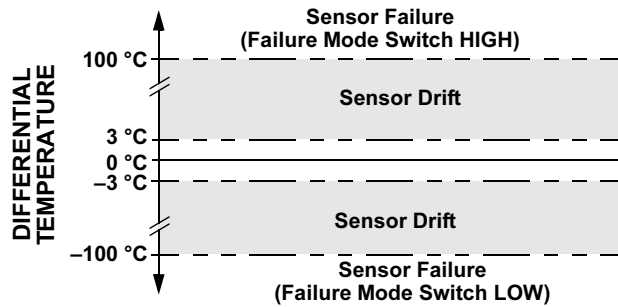

# Rosemount 3144P

HART

## CALIBRATION

Calibrating the transmitter increases the precision of your measurement system. The user may use one or more of a number of trim functions when calibrating. To understand the trim functions, it is necessary to understand that HART transmitters operate differently from analog transmitters. An important difference is that smart transmitters are factory-characterized; they are shipped with a standard sensor curve stored in the transmitter firmware. In operation, the transmitter uses this information to produce a process variable output, dependent on the sensor input. The trim functions allow the user to make adjustments to the factory-stored characterization curve by digitally altering the transmitter's interpretation of the sensor input.

Calibration of the 3144P may include the following procedures:

- Sensor Input Trim: digitally alter the transmitter's interpretation of the input signal
- Transmitter Sensor Matching: generates a special custom curve to match that specific sensor curve, as derived from the Callendar-Van Dusen constants
- Output Trim: calibrates the transmitter to a 4–20 mA reference scale
- Scaled Output Trim: calibrates the transmitter to a user-selectable reference scale.

## TRIM THE TRANSMITTER

The trim functions should not be confused with the rerange functions. Although the rerange command matches a sensor input to a 4–20 mA output—as in conventional calibration—it does not affect the transmitter's interpretation of the input.

One or more of the trim functions may be used when calibrating. The trim functions are as follows

- Sensor Input Trim
- Transmitter Sensor Matching
- Output Trim
- Output Scaled Trim

Figure 3-6. Trim

*Application:* Linear Offset  
*Solution:* Single-Point Trim  
*Method:*

1. Connect sensor to transmitter. Place sensor in bath between range points.
2. Enter known bath temperature using the 375 Field Communicator.

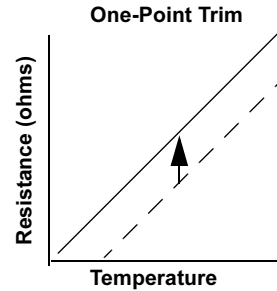

*Application:* Linear Offset and Slope Correction  
*Solution:* Two-Point Trim  
*Method:*

1. Connect sensor to transmitter. Place sensor in bath at low range point.
2. Enter known bath temperature using the 375 Field Communicator.
3. Repeat at high range point.

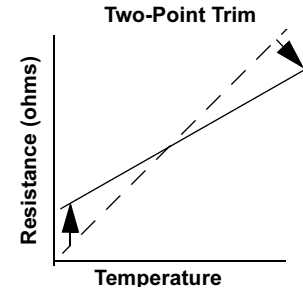

Transmitter System Curve ————  
Site-Standard Curve \_\_\_\_\_

### Sensor Input Trim

HART Fast Keys	1, 2, 2, 1, 1
----------------	---------------

The *Sensor Trim* command allows the user to digitally alter the transmitter's interpretation of the input signal as shown in Figure 3-6 on page 3-29. The sensor trim command trims, in engineering ( $^{\circ}\text{F}$ ,  $^{\circ}\text{C}$ ,  $^{\circ}\text{R}$ ,  $\text{K}$ ) or raw ( $\Omega$ ,  $\text{mV}$ ) units, the combined sensor and transmitter system to a site standard using a known temperature source. Sensor trim is suitable for validation procedures or for applications that require profiling the sensor and transmitter together.

Perform a sensor trim if the transmitters digital value for the primary variable does not match the plant's standard calibration equipment. The sensor trim function calibrates the sensor to the transmitter in temperature units or raw units. Unless the site-standard input source is NIST-traceable, the trim functions will not maintain the NIST-traceability of your system

To perform a sensor trim, use the following procedure:

#### Single Sensor Trim

1. Connect the sensor or calibrator device to the transmitter.
2. Connect the communicator to the transmitter loop.
3. From the Home screen, select *1 Device Setup*, *2 Diag/Service*, *2 Calibration*, *1 Sensor Trim*, *1 Sensor Inp Trim* to prepare to trim the sensor. Select *1 Sensor 1*.
4. Select Sensor 1.

#### NOTE

A warning will appear reminding the user to Set the Control Loop to Manual" (see "Setting the Loop to Manual" on page 2-2.)

5. The communicator will ask "Are you using an active calibrator?"

## Rosemount 3144P

HART

- a. Select “No” if a sensor is connected to the transmitter
- b. Select “Yes” if using a calibration device. By selecting yes, the transmitter will be put into active calibration mode (see “Active Calibrator and EMF Compensation” on page 3-31). This is critical if the calibrator requires constant sensor current for calibration. If using a calibration device that can accept pulsed current, select “No.”
6. Select the appropriate sensor trim units at the **ENTER SNSR 1 TRIM UNITS** prompt.
7. Select *1 Lower Only*, *2 Upper Only* or *3 Lower and Upper* at the **SELECT SENSOR TRIM POINTS** prompt.
8. Adjust the calibration device to the desired trim value (must be within the selected sensor limits). If trimming a combined sensor and transmitter system, expose the sensor to a known temperature and allow the temperature reading to stabilize. Use a bath, furnace or isothermal block, measured with a site-standard thermometer, as the known temperature source.
9. Select **OK** once the temperature stabilizes.
10. Enter the lower or upper trim point, depending on your selection in Step 7.

The trim functions should not be confused with the rerange functions. Although the rerange command matches a sensor input to a 4–20 mA output—as in conventional calibration—it does not affect the transmitter’s interpretation of the input.

*Dual Sensor Trim*

1. Connect the sensor or calibrator device to the transmitter.
  - a. When using sensors, connect the two sensors or a dual element sensor
  - b. When using a calibrator, connect the device to both sensor inputs.
2. Connect the communicator to the transmitter loop.
3. From the Home screen, select *1 Device Setup*, *2 Diag/Service*, *2 Calibration*, *1 Sensor Trim*, *1 Sensor Inp Trim* to prepare to trim the sensor. Select *1 Sensor 1*.
4. The Communicator will prompt the user to select either Sensor 1 or 2. The sensors can be trimmed in either order, but it is recommended to trim Sensor 1 first.

**NOTE**

A warning will appear reminding the user to Set the Control Loop to Manual” (see “Setting the Loop to Manual” on page 2-2.)

5. The communicator will ask “Are you using an active calibrator?”

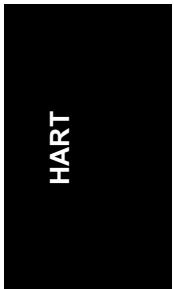

- a. Select "No" if a sensor is connected to the transmitter
- b. Select "Yes" if using a calibration device. By selecting yes, the transmitter will be put into active calibration mode (see "Active Calibrator and EMF Compensation" on page 3-31). This is critical if the calibrator requires constant sensor current for calibration. If using a calibration device that can accept pulsed current, select "No."
6. Select the appropriate sensor trim units at the **ENTER SNSR 1 TRIM UNITS** prompt.
7. Select *1 Lower Only*, *2 Upper Only* or *3 Lower and Upper* at the **SELECT SENSOR TRIM POINTS** prompt.
8. Adjust the calibration device to the desired trim value (must be within the selected sensor limits). If trimming a combined sensor and transmitter system, expose the sensor to a known temperature and allow the temperature reading to stabilize. Use a bath, furnace or isothermal block, measured with a site-standard thermometer, as the known temperature source.
9. Select **OK** once the temperature stabilizes.
10. Enter the lower or upper trim point, depending on your selection in Step 7.

To trim the second sensor, repeat the same procedure only in Step 4, select the sensor not yet calibrated (usually Sensor 2)

#### AMS

For AMS, configure each sensor as indicated above.

Right click on an AI device and select "Diagnostics and Calibration" from the menu. Select "Calibrate," then "Sensor Trim," then "Sensor Input Trim."

The *wizard* will continue through the process.

The transmitter may be restored to the factory default by selecting: "Diagnostics and Calibration," "Sensor Trim," "Revert to Factory Trim."

The *wizard* will recall the factory trim for a given sensor

Apply changes made (see "AMS" on page 3-5).

#### Active Calibrator and EMF Compensation

HART Fast Keys	1, 2, 2, 1, 3
----------------	---------------

The transmitter operates with a pulsating sensor current to allow EMF compensation and detection of open sensor conditions. Because some calibration equipment requires a steady sensor current to function properly, the "Active Calibrator Mode" feature should be used when an Active Calibrator, which requires a constant sensor current, is connected. Enabling this mode will temporarily set the transmitter to provide steady sensor current unless two sensor inputs are configured. Disable this mode before putting the transmitter back into the process. Disabling this mode will set the transmitter back to pulsating current. "Active Calibrator Mode" is volatile and will automatically be disabled when a Master Reset is performed (via HART) or when power is cycled.

## Rosemount 3144P

HART

EMF compensation allows the transmitter to provide sensor measurements that are not affected by unwanted voltages, which are typically due to thermal EMFs in the equipment connected to the transmitter or by some types of calibration equipment. If this equipment also requires steady sensor current, the transmitter must be set to “Active Calibrator Mode.” However, the steady current does not allow the transmitter to perform EMF compensation. As a result, a difference in readings between the Active Calibrator and actual sensor may exist.

If a reading difference is experienced and the difference is greater than the plant’s accuracy specification allows, perform a sensor trim with “Active Calibrator Mode” disabled. In this case, an active calibrator capable of tolerating pulsating sensor current must be used or the actual sensors must be connected to the transmitter. When the 375 Field Communicator or AMS asks if an Active Calibrator is being used when the sensor trim routine is entered, select **No**. This will leave the “Active Calibrator Mode” disabled.

Contact a Emerson Process Management representative for more information.

### Transmitter-Sensor Matching

HART Fast Keys	1, 3, 2, 1, 1
----------------	---------------

The 3144P accepts Callendar-Van Dusen constants from a calibrated RTD schedule and generates a special custom curve to match that specific sensor Resistance vs. Temperature performance. Matching the specific sensor curve with the transmitter significantly enhances the temperature measurement accuracy. See the comparison below:

**System Accuracy Comparison at 150 °C Using a PT 100 ( $\alpha=0.00385$ ) RTD with a Span of 0 to 200 °C**

Standard RTD		Matched RTD	
3144P	±0.10 °C	3144P	±0.10 °C
Standard RTD	±1.05 °C	Matched RTD	±0.18 °C
Total System <sup>(1)</sup>	±1.05 °C	Total System <sup>(1)</sup>	±0.21 °C

(1) Calculated using root-summed-squared (RSS) statistical method

$$\text{TotalSystemAccuracy} = \sqrt{(\text{TransmitterAccuracy})^2 + (\text{SensorAccuracy})^2}$$

The following input constants, included with specially-ordered Rosemount temperature sensors, are required:

$R_0$  = Resistance at Ice Point

Alpha = Sensor Specific Constant

Beta = Sensor Specific Constant

Delta = Sensor Specific Constant

Other sensor may have “A,B, or C” values for constants.

To input Callendar-Van Dusen constants, perform the following procedure:

1. From the **HOME** screen, select *1 Device Setup, 3 Configuration, 2 Sensor Config, 1 Change Type/Conn., 1 Sensor 1*. Select **OK** after you set the control loop to manual.
2. Select *Cal VanDusen* at the **ENTER SENSOR TYPE** prompt.
3. Select the appropriate number of wires at the **ENTER SENSOR CONNECTION** prompt.
4. Enter the  $R_0$ , Alpha, Beta, and Delta values from the stainless steel tag attached to the special-order sensor when prompted.
5. Select **OK** after you return the control loop to automatic control.



To disable the transmitter-sensor matching feature from the **HOME** screen select *1 Device Setup, 3 Configuration, 2 Sensor Config, 1 Change Type/Conn.* Choose the appropriate sensor type from the **ENTER SENSOR TYPE** prompt.

When using two sensors, repeat Steps 1 – 5 for the second sensor. In Step 1, select *Sensor 2* instead of *Sensor 1*.

**NOTE**

When you disable transmitter-sensor matching, the transmitter reverts to factory trim input. Make certain the transmitter engineering units default correctly before placing the transmitter into service.

Callendar Van-Dusen constants can be viewed anytime by making the following selections:

From the Home screen select *1 Device Setup, 3 Configuration, 2 Sensor Config, 2 Show Type/Conn.*

**AMS**

Right click on the device and select “Configuration” from the menu. Select the “Sensor connections.” Change the Type and Connection.

The *wizard* will go through the required changes. In the field, select “Cal VanDusen to enter the sensor type.

**D/A Output Trim or Scaled Output Trim**

Perform an D/A output trim (scaled output trim) if the digital value for the primary variable matches the plant standard but the transmitter’s analog output does not match the digital value on the output device, such as the ampmeter. The output trim function calibrates the transmitter analog output to a 4–20 mA reference scale; the scaled output trim function calibrates to a user-selectable reference scale. To determine the need for an output trim or a scaled output trim, perform a loop test (see “Loop Test” on page 3-22).

Figure 3-7. Dynamics of Smart Temperature Measurement

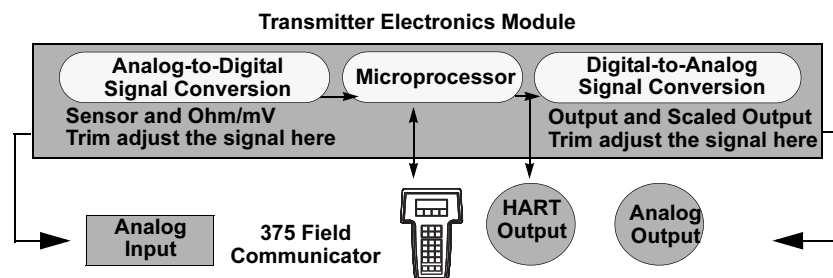

**Output Trim**

HART Fast Keys	1, 2, 2, 2
----------------	------------

The *D/A Trim* command allows the user to alter the transmitter’s conversion of the input signal to a 4–20 mA output (see Figure 3-7 on page 3-33). Calibrate the analog output signal at regular intervals to maintain measurement precision. To perform a digital-to-analog trim, perform the following procedure:

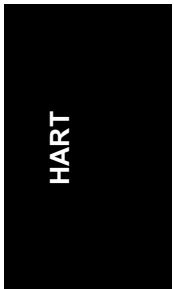

1. From the **HOME** screen, select *1 Device setup, 2 Diag/Service, 2 Calibration, 2 D/A trim*. Set the control loop to manual and select **OK**.
2. Connect an accurate reference meter to the transmitter at the **CONNECT REFERENCE METER** prompt. To do so, shunt the power to the transmitter through the reference meter at some point in the loop. Select **OK** after connecting the reference meter.
3. Select **OK** at the **SETTING FLD DEV OUTPUT TO 4 MA** prompt. The transmitter outputs 4.00 mA.
4. Record the actual value from the reference meter, and enter it at the **ENTER METER VALUE** prompt. The communicator prompts the user to verify if the output value equals the value on the reference meter.
5. If the reference meter value equals the transmitter output value, then select *1 Yes* and go to step 6. If the reference meter value does not equal the transmitter output value, then select *2 No* and go to step 4.
6. Select **OK** at the **SETTING FLD DEV OUTPUT TO 20 MA** prompt and repeat steps 4 and 5 until the reference meter value equals the transmitter output value.
7. Return the control loop to automatic control and select **OK**.

**AMS**

Right click on the device and select "Diagnostics and Calibration" from the menu. Select the "Calibrate" and choose the "D/A Trim."

This *wizard* will go through the required changes.

**Scaled Output Trim**

HART Fast Keys	1, 2, 2, 3
----------------	------------

The *Scaled D/A Trim* command matches the 4 and 20 mA points to a user-selectable reference scale other than 4 and 20 mA (2–10 volts, for example). To perform a scaled D/A trim, connect an accurate reference meter to the transmitter and trim the output signal to scale as outlined in the "Output Trim" procedure.

**AMS**

Right click on the device and select "Diagnostics and Calibration" from the menu. Select the "Calibrate" and choose the "Scaled D/A Trim."

This *wizard* will go through the required changes.

**TROUBLESHOOTING**

**HART / 4–20 mA**

If a malfunction is suspected despite the absence of a diagnostics message on the 375 Field Communicator display, follow the procedures described in Table 3-1 to verify that transmitter hardware and process connections are in good working order. Under each of four major symptoms, specific suggestions are offered for solving problems. Always deal with the most likely and easiest-to-check conditions first.

Advanced troubleshooting information is available in Table 3-2 on page 3-36.

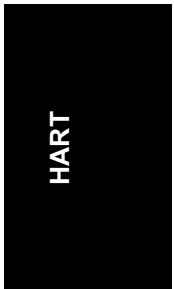

Table 3-1. HART / 4–20 mA Basic Troubleshooting

Symptom	Potential Source	Corrective Action
Transmitter Does Not Communicate with 375 Field Communicator	Loop Wiring	<ul style="list-style-type: none"> <li>Check the revision level of the transmitter device descriptors (DDs) stored in your communicator. The communicator should report Dev v3, DD v2 (improved), or Dev v2, DD v1 (previous). Contact Emerson Process Management Customer Central for assistance.</li> <li>Check for a minimum of 250 ohms resistance between the power supply and 375 Field Communicator connection.</li> <li>Check for adequate voltage to the transmitter. If a 375 Field Communicator is connected and 250 ohms resistance is properly in the loop, then the transmitter requires a minimum of 12.0 V at the terminals to operate (over entire 3.90 to 20.5 mA operating range), and 17.5 V minimum to communicate digitally.</li> <li>Check for intermittent shorts, open circuits, and multiple grounds.</li> </ul>
High Output	Sensor Input Failure or Connection	<ul style="list-style-type: none"> <li>Connect a 375 Field Communicator and enter the transmitter test mode to isolate a sensor failure.</li> <li>Check for a sensor open circuit.</li> <li>Check if the process variable is out of range.</li> </ul>
	Loop Wiring	<ul style="list-style-type: none"> <li>Check for dirty or defective terminals, interconnecting pins, or receptacles.</li> </ul>
	Power Supply	<ul style="list-style-type: none"> <li>Check the output voltage of the power supply at the transmitter terminals. It should be 12.0 to 42.4 V dc (over entire 3.90 to 20.5 mA operating range).</li> </ul>
Erratic Output	Electronics Module	<ul style="list-style-type: none"> <li>Connect a 375 Field Communicator and enter the transmitter test mode to isolate module failure.</li> <li>Connect a 375 Field Communicator and check the sensor limits to ensure calibration adjustments are within the sensor range.</li> </ul>
	Loop wiring	<ul style="list-style-type: none"> <li>Check for adequate voltage to the transmitter. It should be 12.0 to 42.4 V dc at the transmitter terminals (over entire 3.90 to 20.5 mA operating range).</li> <li>Check for intermittent shorts, open circuits, and multiple grounds.</li> <li>Connect a 375 Field Communicator and enter the loop test mode to generate signals of 4 mA, 20 mA, and user-selected values.</li> </ul>
Low Output or No Output	Sensor Element	<ul style="list-style-type: none"> <li>Connect a 375 Field Communicator and enter the transmitter test mode to isolate a sensor failure.</li> <li>Check if the process variable is out of range.</li> </ul>
	Loop Wiring	<ul style="list-style-type: none"> <li>Check for adequate voltage to the transmitter. It should be 12.0 to 42.4 V dc (over entire 3.90 to 20.5 mA operating range).</li> <li>Check for shorts and multiple grounds.</li> <li>Check for proper polarity at the signal terminal.</li> <li>Check the loop impedance.</li> <li>Connect a 375 Field Communicator and enter the loop test mode.</li> <li>Check wire insulation to detect possible shorts to ground.</li> </ul>
	Electronics Module	<ul style="list-style-type: none"> <li>Connect a 375 Field Communicator and check the sensor limits to ensure calibration adjustments are within the sensor range.</li> <li>Connect a 375 Field Communicator and enter the transmitter test mode to isolate an electronics module failure.</li> </ul>

## Rosemount 3144P

HART

Table 3-2. 375 Field Communicator Error Warning Descriptions – HART<sup>(1)</sup>

Message	Description
Add item for ALL device types or only for this ONE device type	Asks the user whether the hot key item being added should be added for all device types or only for the type of device that is connected.
Command not implemented	The connected device does not support this function.
Communication error	Either a device sends back a response indicating that the message it received was unintelligible, or the 375 Field Communicator cannot understand the response from the device.
Configuration memory not compatible with connected device	The configuration stored in memory is incompatible with the device to which a transfer has been requested.
Device busy	The connected device is busy performing another task.
Device disconnected	Device fails to respond to a command.
Device write protected	Device is in write-protect mode. Data can not be written.
Device write protected. Do you still want to shut off?	Device is in write-protect mode. Press YES to turn the 375 Field Communicator off and lose the unsent data.
Display value of variable on hot key menu?	Asks whether the value of the variable should be displayed adjacent to its label on the hot key menu if the item being added to the hot key menu is a variable.
Download data from configuration memory to device	Prompts user to press SEND softkey to initiate a memory to device transfer.
Exceed field width	Indicates that the field width for the current arithmetic variable exceeds the device-specified description edit format.
Exceed precision	Indicates that the precision for the current arithmetic variable exceeds the device-specified description edit format.
Ignore next 50 occurrences of status?	Asked after displaying device status. Softkey answer determines whether next 50 occurrences of device status will be ignored or displayed.
Illegal character	An invalid character for the variable type was entered.
Illegal date	The day portion of the date is invalid.
Illegal month	The month portion of the date is invalid.
Illegal year	The year portion of the date is invalid.
Incomplete exponent	The exponent of a scientific notation floating point variable is incomplete.
Incomplete field	The value entered is not complete for the variable type.
Looking for a device	Polling for multidropped devices at addresses 1–15.
Mark as read only variable on hotkey menu?	Asks whether the user should be allowed to edit the variable from the hotkey menu if the item being added to the hotkey menu is a variable.
No device configuration in configuration memory	There is no configuration saved in memory available to re-configure off-line or transfer to a device.
No device found	Poll of address zero fails to find a device, or poll of all addresses fails to find a device if auto-poll is enabled.
No hotkey menu available for this device.	There is no menu named "hotkey" defined in the device description for this device.
No offline devices available	There are no device descriptions available to be used to configure a device offline.
No simulation devices available	There are no device descriptions available to simulate a device.
No UPLOAD_VARIABLES in ddl for this device	There is no menu named "upload_variables" defined in the device description for this device. This menu is required for offline configuration.
No valid items	The selected menu or edit display contains no valid items.
OFF KEY DISABLED	Appears when the user attempts to turn the 375 Field Communicator off before sending modified data or before completing a method.
Online device disconnected with unsent data. RETRY or OK to lose data	There is unsent data for a previously connected device. Press RETRY to send data, or press OK to disconnect and lose unsent data.

Table 3-2. 375 Field Communicator Error Warning Descriptions – HART<sup>(1)</sup>

Message	Description
Out of memory for hotkey configuration. Delete unnecessary items.	There is no more memory available to store additional hotkey items. Unnecessary items should be deleted to make space available.
Overwrite existing configuration memory	Requests permission to overwrite existing configuration either by a device-to-memory transfer or by an offline configuration. User answers using the softkeys.
Press OK	Press the OK softkey. This message usually appears after an error message from the application or as a result of HART communications.
Restore device value?	The edited value that was sent to a device was not properly implemented. Restoring the device value returns the variable to its original value.
Save data from device to configuration memory	Prompts user to press SAVE softkey to initiate a device-to-memory transfer.
Saving data to configuration memory	Data is being transferred from a device to configuration memory.
Sending data to device	Data is being transferred from configuration memory to a device.
There are write only variables which have not been edited. Please edit them	There are write-only variables that have not been set by the user. These variables should be set or invalid values may be sent to the device.
There is unsent data. Send it before shutting off?	Press YES to send unsent data and turn the 375 Field Communicator off. Press NO to turn the 375 Field Communicator off and lose the unsent data.
Too few data bytes received	Command returns fewer data bytes than expected as determined by the device description.
Transmitter fault	Device returns a command response indicating a fault with the connected device.
Units for <variable label> has changed. Unit must be sent before editing, or invalid data will be sent.	The engineering units for this variable have been edited. Send engineering units to the device before editing this variable.
Unsent data to online device. SEND or LOSE data	There is unsent data for a previously connected device which must be sent or thrown away before connecting to another device.
Use up/down arrows to change contrast. Press DONE when done.	Gives direction to change the contrast of the 375 Field Communicator display.
Value out of range	The user-entered value is either not within the range for the given type and size of variable or not within the min/max specified by the device.
<message> occurred reading/writing <variable label>	Either a read/write command indicates too few data bytes received, transmitter fault, invalid response code, invalid response command, invalid reply data field, or failed pre- or post-read method; or a response code of any class other than SUCCESS is returned reading a particular variable.
<variable label> has an unknown value. Unit must be sent before editing, or invalid data will be sent.	A variable related to this variable has been edited. Send related variable to the device before editing this variable.

(1) Variable parameters within the text of a message are indicated with <variable parameter>. Reference to the name of another message is identified by [another message].

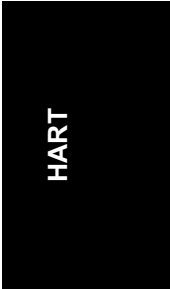

## Rosemount 3144P

## LCD Display

The LCD display displays abbreviated diagnostic messages for troubleshooting the transmitter. To accommodate two-word messages, the display alternates between the first and second word. Some diagnostic messages have a higher priority than others, so messages appear according to their priority, with normal operating messages appearing last. Messages on the *Process Variable* line refer to general device conditions, while messages on the *Process Variable Unit* line refer to specific causes for these conditions. A description of each diagnostic message follows.

Table 3-3. LCD Display Error Warning Descriptions

Message	Description
[BLANK]	If the meter does not appear to function, make sure the transmitter is configured for the meter option you desire. The meter will not function if the LCD Display option is set to Not Used.
FAIL -or- HDWR FAIL	This message indicates one of several conditions including: The transmitter has experienced an electronics module failure. The transmitter self-test has failed. If diagnostics indicate a failure of the electronics module, replace the electronics module with a new one. Contact the nearest Emerson Process Management Field Service Center if necessary.
SNSR 1 FAIL -or- SNSR 2 FAIL	The transmitter has detected an open or shorted sensor condition. The sensor(s) might be disconnected, connected improperly, or malfunctioning. Check the sensor connections and sensor continuity.
SNSR 1 SAT -or- SNSR 2 SAT	The temperature sensed by the transmitter exceeds the sensor limits for this particular sensor type.
HOUSG SAT	The transmitter operating temperature limits (-40 to 185 °F (40 to 85 °C)) have been exceeded.
LOOP FIXED	During a loop test or a 4–20 mA output trim, the analog output defaults to a fixed value. The <i>Process Variable</i> line of the display alternates between the amount of current selected in milliamperes and “WARN.” The <i>Process Variable Unit</i> line toggles between “LOOP,” “FIXED,” and the amount of current selected in milliamperes.
OFLOW	The location of the decimal point, as configured in the meter setup, is not compatible with the value to be displayed by the meter. For example, if the meter is measuring a process temperature greater than 9.9999 degrees, and the meter decimal point is set to 4 digit precision, the meter will display an “OFLOW” message because it is only capable of displaying a maximum value of 9.9999 when set to 4 digit precision.
HOT BU	Hot Backup is enabled and Sensor 1 has failed. This message is displayed on the <i>Process Variable</i> line and is always accompanied by a more descriptive message on the <i>Process Variable Unit</i> line. In the case of a Sensor 1 failure with Hot Backup enabled, for example, the <i>Process Variable</i> line displays “HOT BU,” and the <i>Process Variable Unit</i> line alternates between “SNSR 1” and “FAIL.”
WARN DRIFT ALERT	Drift Alert warning is enabled and the difference between Sensor 1 and Sensor 2 has exceeded the user-specified limit. One of the sensors may be malfunctioning. The <i>Process Variable</i> line displays “WARN” and the <i>Process Variable Unit</i> line alternates between “DRIFT” and “ALERT.”
ALARM DRIFT ALERT	The analog output is in alarm. Drift Alert alarm is enabled and the difference between Sensor 1 and Sensor 2 has exceeded the user-specified limit. The transmitter is still operating, but one of the sensors may be malfunctioning. The <i>Process Variable</i> line displays “ALARM” and the <i>Process Variable Unit</i> line alternates between “DRIFT” and “ALERT.”
ALARM	The digital and analog outputs are in alarm. Possible causes of this condition include, but are not limited to, an electronics failure or an open sensor. This message is displayed on the <i>Process Variable</i> line and is always accompanied by a more descriptive message on the <i>Process Variable Unit</i> line. In the case of a Sensor 1 failure, for example, the <i>Process Variable</i> line displays “ALARM,” and the <i>Process Variable Unit</i> line alternates between “SNSR 1” and “FAIL.”
WARN	The transmitter is still operating, but something is not correct. Possible causes of this condition include, but are not limited to, an out-of-range sensor, a fixed loop, or an open sensor condition. In the case of a Sensor 2 failure with Hot Backup enabled, the <i>Process Variable</i> line displays “WARN,” and the <i>Process Variable Unit</i> line alternates between “SNSR 2” and “RANGE.”

**AMS Software (HART / 4-20 mA only)**

If a malfunction is suspected despite the absence of a diagnostics message, follow the procedures described in Table 3-4 to verify that transmitter hardware and process connections are in good working order. Under each of four major symptoms, specific suggestions are offered for solving problems. Always deal with the most likely and easiest-to-check conditions first.

Advanced troubleshooting information is available in Table 3-5 on page 3-40.

AMS also provides help screens to assist in message communication. See “When the Drift Alert warning or alarm is enable, they indicate that the differences between Sensor 1 and Sensor 2 has exceeded the user-specified limit. One of the sensors may be malfunctioning. The sensors should both be investigated at the earliest opportunity.” on page 3-42.

Table 3-4. AMS Basic Troubleshooting

Symptom	Potential Source	Corrective Action
Transmitter Does Not Communicate with AMS Software	Loop Wiring	<ul style="list-style-type: none"> <li>Check the revision level of the transmitter device descriptors (DDs) stored in your software. The communicator should report Dev v3, DD v2 (improved), or Dev v2, DD v1 (previous). Contact Emerson Process Management Customer Central for assistance.</li> <li>Check for a minimum of 250 ohms resistance between the power supply and AMS software.</li> <li>Check for adequate voltage to the transmitter. If the AMS software is connected and 250 ohms resistance is properly in the loop, then the transmitter requires a minimum of 12.0 V at the terminals to operate (over entire 3.90 to 20.5 mA operating range), and 17.5 V minimum to communicate digitally.</li> <li>Check for intermittent shorts, open circuits, and multiple grounds.</li> </ul>
High Output	Sensor Input Failure or Connection	<ul style="list-style-type: none"> <li>Using AMS, set the transmitter test mode to isolate a sensor failure.</li> <li>Check for a sensor open circuit.</li> <li>Check if the process variable is out of range.</li> </ul>
	Loop Wiring	<ul style="list-style-type: none"> <li>Check for dirty or defective terminals, interconnecting pins, or receptacles.</li> </ul>
	Power Supply	<ul style="list-style-type: none"> <li>Check the output voltage of the power supply at the transmitter terminals. It should be 12.0 to 42.4 V dc (over entire 3.90 to 20.5 mA operating range).</li> </ul>
	Electronics Module	<ul style="list-style-type: none"> <li>Using AMS, set the transmitter test mode to isolate module failure.</li> <li>Using AMS, check the sensor limits to ensure calibration adjustments are within the sensor range.</li> </ul>
Erratic Output	Loop wiring	<ul style="list-style-type: none"> <li>Check for adequate voltage to the transmitter. It should be 12.0 to 42.4 V dc at the transmitter terminals (over entire 3.90 to 20.5 mA operating range).</li> <li>Check for intermittent shorts, open circuits, and multiple grounds.</li> <li>Using AMS, set the loop test mode to generate signals of 4 mA, 20 mA, and user-selected values.</li> </ul>
	Electronics Module	<ul style="list-style-type: none"> <li>Using AMS, set the transmitter test mode to isolate module failure.</li> </ul>
Low Output or No Output	Sensor Element	<ul style="list-style-type: none"> <li>Using AMS, set the transmitter test mode to isolate a sensor failure.</li> <li>Check if the process variable is out of range.</li> </ul>
	Loop Wiring	<ul style="list-style-type: none"> <li>Check for adequate voltage to the transmitter. It should be 12.0 to 42.4 V dc (over entire 3.90 to 20.5 mA operating range).</li> <li>Check for shorts and multiple grounds.</li> <li>Check for proper polarity at the signal terminal.</li> <li>Check the loop impedance.</li> <li>Set the loop test mode.</li> <li>Check wire insulation to detect possible shorts to ground.</li> </ul>
	Electronics Module	<ul style="list-style-type: none"> <li>Using AMS, check the sensor limits to ensure calibration adjustments are within the sensor range.</li> <li>Using AMS, set the transmitter test mode to isolate an electronics module failure.</li> </ul>

## Rosemount 3144P

Table 3-5. AMS Error Warning Descriptions<sup>(1)</sup>

Message	Description
Command not implemented	The connected device does not support this function.
Communication error	Either a device sends back a response indicating that the message it received was unintelligible, or the 375 Field Communicator cannot understand the response from the device.
Device busy	The connected device is busy performing another task.
Device disappears from list	Device fails to respond to a command.
Device write protected	Device is in write-protect mode. Data can not be written.
Illegal character	An invalid character for the variable type was entered.
Illegal date	The day portion of the date is invalid.
Illegal month	The month portion of the date is invalid.
Illegal year	The year portion of the date is invalid.
Incomplete exponent	The exponent of a scientific notation floating point variable is incomplete.
Incomplete field	The value entered is not complete for the variable type.
Sending data to device	Data is being transferred from configuration memory to a device.
There are write only variables which have not been edited. Please edit them	There are write-only variables that have not been set by the user. These variables should be set or invalid values may be sent to the device.
There is unsent data. Send it before shutting off?	Press YES to send unsent data and turn the 375 Field Communicator off. Press NO to turn the 375 Field Communicator off and lose the unsent data.
Too few data bytes received	Command returns fewer data bytes than expected as determined by the device description.
Transmitter fault	Device returns a command response indicating a fault with the connected device.
Units for <variable label> has changed. Unit must be sent before editing, or invalid data will be sent.	The engineering units for this variable have been edited. Send engineering units to the device before editing this variable.
Unsent data to online device. SEND or LOSE data	There is unsent data for a previously connected device which must be sent or thrown away before connecting to another device.
Value out of range	The user-entered value is either not within the range for the given type and size of variable or not within the min/max specified by the device.
<message> occurred reading/writing <variable label>	Either a read/write command indicates too few data bytes received, transmitter fault, invalid response code, invalid response command, invalid reply data field, or failed pre- or post-read method; or a response code of any class other than SUCCESS is returned reading a particular variable.
<variable label> has an unknown value. Unit must be sent before editing, or invalid data will be sent.	A variable related to this variable has been edited. Send related variable to the device before editing this variable.

(1) These messages are communicated through pop-up menus.



**AMS Screens**

AMS provides advanced diagnostic messages, as well as help screens for the messages. Using the help screens can provide quick reference to remedying the situation. The trouble shooting section for this manual can also be pasted in AMS to assist in quick and accurate troubleshooting reference.

**Alarms and Alerts**

Right click on the device and select “Process Variables”. This screen shows the sensor reading and status of the sensor and transmitters. If no alarms or alerts are activated, the screen will look like this:

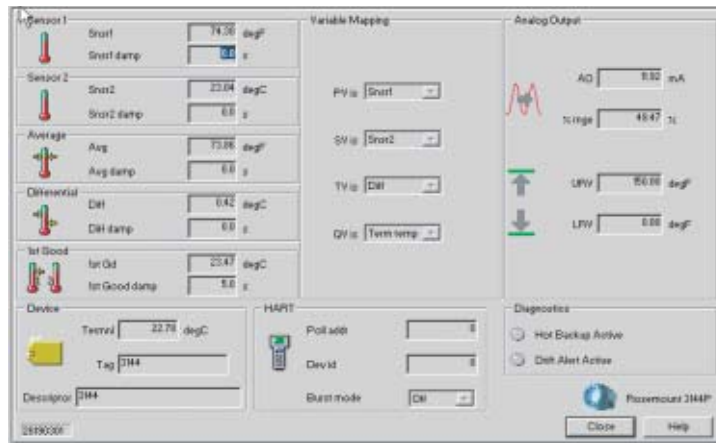

**Sensor Failure**

When the transmitter has detected an open or shorted sensor condition, the sensor(s) might be disconnected, connected improperly, or malfunctioning. Check the Sensor connections and continuity. Replace the sensor if necessary.

By right-clicking on the device and selecting “status,” the status screen appears. This screen shows an overview of the transmitter health. Red bars indicate system changes or that the transmitter is not working properly and should be investigated.

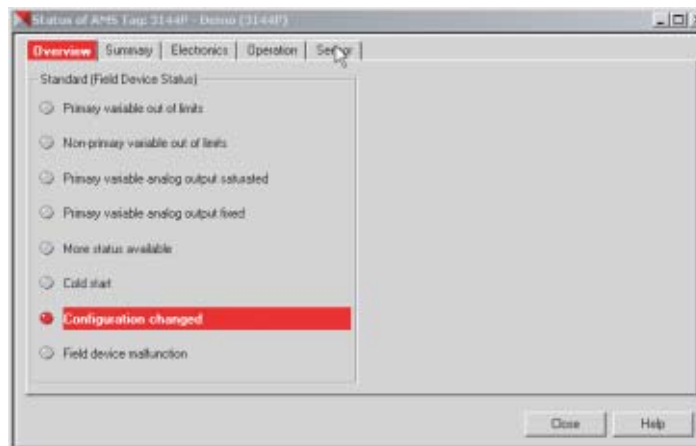

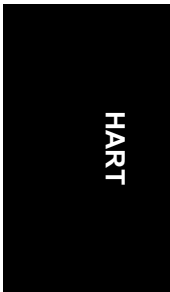

### Hot Backup®

Hot Backup is enabled and Sensor 1 or Sensor 2 has failed. The following is displayed on the Process Variable Screen. The suspect sensor should be investigated as soon as possible, and replaced as necessary.

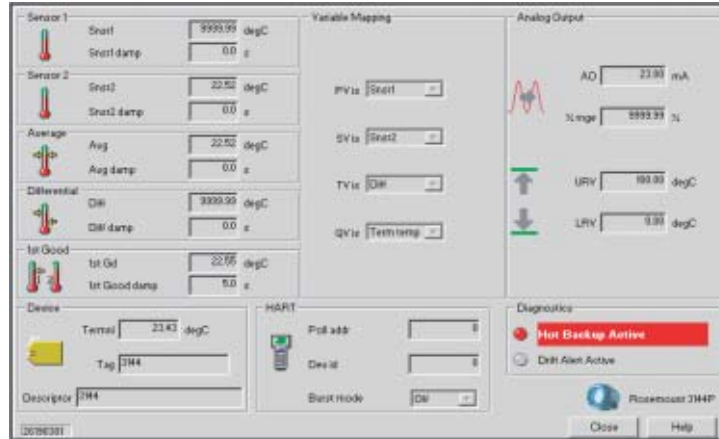

### Sensor Drift Alarm

When the Drift Alert warning or alarm is enable, they indicate that the differences between Sensor 1 and Sensor 2 has exceeded the user-specified limit. One of the sensors may be malfunctioning. The sensors should both be investigated at the earliest opportunity.

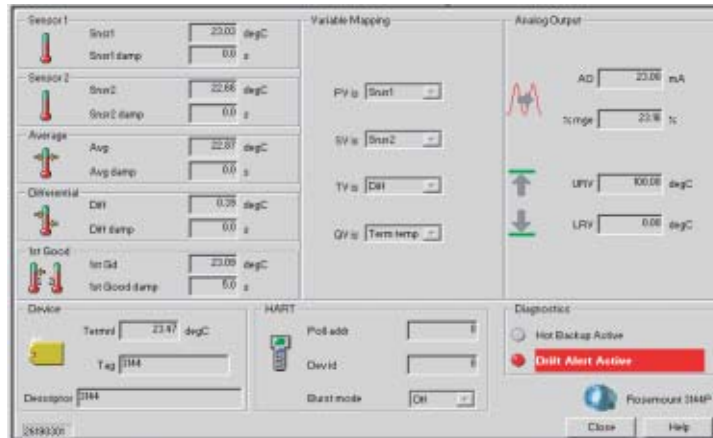

# Section 4 FOUNDATION Fieldbus Configuration

Overview .....	page 4-1
Safety Messages .....	page 4-1
General Block Information .....	page 4-2
Foundation fieldbus function blocks .....	page 4-4
Resource Block .....	page 4-5
Sensor Transducer Block .....	page 4-10
LCD Transducer Block .....	page 4-11
Analog Input (AI) .....	page 4-14
Operation .....	page 4-20
Troubleshooting Guides .....	page 4-25

FOUNDATION Fieldbus

## OVERVIEW

This section provides information on configuring, troubleshooting, operating, and maintaining the 3144P transmitter using FOUNDATION fieldbus protocol.

## SAFETY MESSAGES

Instructions and procedures in this section may require special precautions to ensure the safety of the personnel performing the operations. Information that potentially raises safety issues is indicated by a warning symbol (⚠). Please refer to the following safety messages before performing an operation preceded by this symbol.

### ⚠ WARNING

**Failure to follow these installation guidelines could result in death or serious injury.**

- Make sure only qualified personnel perform the installation.

**Explosions could result in death or serious injury.**

- Do not remove the connection head cover in explosive atmospheres when the circuit is live.
- Before powering a FOUNDATION fieldbus segment in an explosive atmosphere, make sure the instruments in the loop are installed in accordance with intrinsically safe or non-incendive field wiring practices.
- Verify that the operating atmosphere of the transmitter is consistent with the appropriate hazardous locations certifications.
- All connection head covers must be fully engaged to meet explosion-proof requirements.

**Process leaks could result in death or serious injury.**

- Do not remove the thermowell while in operation.
- Install and tighten thermowells and sensors before applying pressure

**Electrical shock could cause death or serious injury.**

- Use extreme caution when making contact with the leads and terminals.

# Rosemount 3144P

## GENERAL BLOCK INFORMATION

### Device Description

Before configuring the device, ensure the host has the appropriate Device Description file revision for this device. The device descriptor can be found on [www.rosemount.com](http://www.rosemount.com). The initial release of the Rosemount 3144P with FOUNDATION fieldbus protocol is device revision 1.

### Node Address

The transmitter is shipped at a temporary (248) address. This will enable FOUNDATION fieldbus host systems to automatically recognize the device and move it to a permanent address.

### Modes

The Resource, Transducer, and all function blocks in the device have modes of operation. These modes govern the operation of the block. Every block supports both automatic (AUTO) and out of service (OOS) modes. Other modes may also be supported.

#### Changing Modes

To change the operating mode, set the `MODE_BLK.TARGET` to the desired mode. After a short delay, the parameter `MODE_BLOCK.ACTUAL` should reflect the mode change if the block is operating properly.

#### Permitted Modes

It is possible to prevent unauthorized changes to the operating mode of a block. To do this, configure `MODE_BLOCK.PERMITTED` to allow only the desired operating modes. It is recommended to always select OOS as one of the permitted modes.

#### Types of Modes

For the procedures described in this manual, it will be helpful to understand the following modes:

##### **AUTO**

The functions performed by the block will execute. If the block has any outputs, these will continue to update. This is typically the normal operating mode.

##### **Out of Service (OOS)**

The functions performed by the block will not execute. If the block has any outputs, these will typically not update and the status of any values passed to downstream blocks will be "BAD". To make some changes to the configuration of the block, change the mode of the block to OOS. When the changes are complete, change the mode back to AUTO.

##### **MAN**

In this mode, variables that are passed out of the block can be manually set for testing or override purposes.

##### **Other Types of Modes**

Other types of modes are Cas, RCas, ROut, IMan and LOW. Some of these may be supported by different function blocks in the 3144P. For more information, see the Function Block manual (document number 00809-0100-4783).

**NOTE**

When an upstream block is set to OOS, this will impact the output status of all downstream blocks. The figure below depicts the hierarchy of blocks:

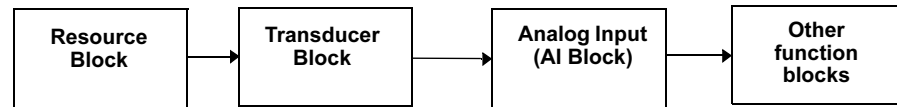

**Link Active Scheduler**

The 3144P can be designated to act as the backup Link Active Scheduler (LAS) in the event that the designated LAS is disconnected from the segment. As the backup LAS, the 3144P will take over the management of communications until the host is restored.

The host system may provide a configuration tool specifically designed to designate a particular device as a backup LAS. Otherwise, this can be configured manually as follows:

- ⚠ 1. Access the Management Information Base (MIB) for the 3144P. To activate the LAS capability, write 0x02 to the BOOT\_OPERAT\_FUNCTIONAL\_CLASS object (Index 605). To deactivate, write 0x01.
- 2. Restart the device.

**Block Instantiation**

Rosemount devices are pre-configured with function blocks at the factory, the default configuration for the 3144P is listed below. The 3144P can have up to three additional instantiated function blocks (nine instantiated, four permanent, three additional).

- 3 Analog Input Blocks (tag names AI 1400, AI 1500, AI 1600)
- 2 Proportional/Integral/Derivative Block (tag name PID 1700, PID 1800)
- Input Selector (tag names ISEL 1900)
- Signal Characterizer (tag name CHAR 2000)
- Arithmetic (tag name ARTH 2100)
- Output Splitter (tag name OSPL 2200)

The four permanent blocks are as follows:

- Resource
- Transducer
- LCD
- SPM

The 3144P supports the use of Function Block Instantiation. When a device supports block instantiation, the number of blocks and block types can be defined to match specific application needs. The number of blocks that can be instantiated is only limited by the amount of memory within the device and the block types that are supported by the device. Instantiation does not apply to permanent device blocks like the Resource, Sensor Transducer, LCD Transducer, and Advanced Diagnostics Blocks.

By reading the parameter "FREE\_SPACE" in the Resource block you can determine how many blocks you can instantiate. Each block that you instantiate takes up 4.5% of the "FREE\_SPACE".

## Capabilities

Table 4-1. Network Parameters

Network Parameter	Value
Slot Time	8
Maximum Response Delay	2
Maximum Inactivity to Claim LAS Delay	32
Minimum Inter DLPDU Delay	8
Time Sync class	4 (1 ms)
Maximum Scheduling Overhead	21
Per CLPDU PhL Overhead	4
Maximum Inter-channel Signal Skew	0
Required Number of Post-transmission-gab-ext Units	0
Required Number of Preamble-extension Units	1

### Block Execution times

Block	Execution Time
Resource	–
Transducer	–
LCD Block	–
Advanced Diagnostics	–
Analog Input 1, 2, 3	60 ms
PID 1 and 2 with Autotune	90 ms
Input Selector	65 ms
Signal Characterizer	45 ms
Arithmetic	60 ms
Output Splitter	60 ms

## FOUNDATION FIELDBUS FUNCTION BLOCKS

For reference information on the Resource, Sensor Transducer, AI, LCD Transducer blocks refer to “Foundation Fieldbus Block Information” on page A-1. Reference information on the PID block can be found in the Function Block manual document number 00809-0100-4783.

### Resource Block (index number 1000)

The Resource Function Block (RB) contains diagnostic, hardware and electronics information. There are no linkable inputs or outputs to the Resource Block.

### Sensor Transducer Block (index number 1100)

The Sensor Transducer Function Block (STB) temperature measurement data, including sensor and terminal temperature, The STB also includes information about sensor type, engineering units, linearization, reranging, damping, temperature compensation, and diagnostics.

### LCD Transducer Block (index number 1200)

The LCD Transducer Block is used to configure the LCD display.

**Analog Input Block (index number 1400, 1500, and 1600)**

The Analog Input Function Block (AI) processes the measurements from the sensor and makes them available to other function blocks. The output value from the AI block is in engineering units and contains a status indicating the quality of the measurement. The AI block is widely used for scaling functionality.

**PID Block (index number 1700 and 1800)**

The PID Function Block combines all of the necessary logic to perform proportional/integral/derivative (PID) control. The block supports mode control, signal scaling and limiting, feed forward control, override tracking, alarm limit detection, and signal status propagation.

The block supports two forms of the PID equation: Standard and Series. You can choose the appropriate equation using the MATHFORM parameter. The Standard ISA PID equation is the default selection and Autotune.

**Input Selector (index number 1900)**

The signal selector block provides selection of up to four inputs and generates an output based on the configured action. This block normally receives its inputs from AI blocks. The block performs maximum, minimum, middle, average and 'first good' signal selection.

**Output Splitter (index number OSPL 2200)**

The output splitter block provides the capability to drive two control outputs from a single input. Each output is a linear function of some portion of the input.

**Arithmetic (index number 2100)**

This block is designed to permit simple use of popular measurement math functions. The user does not have to know how to write equations. The math algorithm is selected by name, chosen by the user for the function to be done.

**Signal Characterizer (index number 2000)**

The signal characterizer block has two sections, each with an output that is a non-linear function of the respective input. The non-linear function is determined by a single look-up table with 21 arbitrary x-y pairs. The status of an input is copied to the corresponding output, so the block may be used in the control or process signal path.

**RESOURCE BLOCK**

**FEATURES and  
FEATURES\_SEL**

The parameters FEATURES and FEATURE\_SEL determine optional behavior of the 3144P.

**FEATURES**

The FEATURES parameter is read only and defines which features are supported by the 3144P. Below is a list of the FEATURES the 3144P supports.

**UNICODE**

All configurable string variables in the 3144P, except tag names, are octet strings. Either ASCII or Unicode may be used. If the configuration device is generating Unicode octet strings, you must set the Unicode option bit.

# Rosemount 3144P

## REPORTS

The 3144P supports alert reports. The Reports option bit must be set in the features bit string to use this feature. If it is not set, the host must poll for alerts.

## SOFTWARE LOCK and HARDWARE LOCK

Inputs to the security and write lock functions include the hardware security switch, the hardware and software write lock bits of the FEATURE\_SEL parameter, the WRITE\_LOCK parameter, and the DEFINE\_WRITE\_LOCK parameter.

The WRITE\_LOCK parameter prevents modification of parameters within the device except to clear the WRITE\_LOCK parameter. During this time, the block will function normally updating inputs and outputs and executing algorithms. When the WRITE\_LOCK condition is cleared, a WRITE\_ALM alert is generated with a priority that corresponds to the WRITE\_PRI parameter.

The FEATURE\_SEL parameter enables the user to select a hardware or software write lock or no write lock capability. To enable the hardware security function, enable the HW\_SEL bit in the FEATURE\_SEL parameter. When this bit has been enabled the WRITE\_LOCK parameter becomes read only and will reflect the state of the hardware switch. In order to enable the software write lock, the SW\_SEL bit must be set in the FEATURE\_SEL parameter. Once this bit is set, the WRITE\_LOCK parameter may be set to "Locked" or "Not Locked." Once the WRITE\_LOCK parameter is set to "Locked" by either the software or the hardware lock, all user requested writes as determined by the DEFINE\_WRITE\_LOCK parameter shall be rejected.

The DEFINE\_WRITE\_LOCK parameter allows the user to configure whether the write lock functions (both software and hardware) will control writing to all blocks, or only to the resource and transducer blocks. Internally updated data such as process variables and diagnostics will not be restricted by the security switch.

The following table displays all possible configurations of the WRITE\_LOCK parameter.

FEATURE_SEL HW_SEL bit	FEATURE_SEL SW_SEL bit	SECURITY SWITCH	WRITE_LOCK	WRITE_LOCK Read/Write	DEFINE_WRITE_LOCK	Write access to blocks
0 (off)	0 (off)	NA	1 (unlocked)	Read only	NA	All
0 (off)	1 (on)	NA	1 (unlocked)	Read/Write	NA	All
0 (off)	1 (on)	NA	2 (locked)	Read/Write	Physical	Function Blocks only
0 (off)	1 (on)	NA	2 (locked)	Read/Write	Everything	None
1 (on)	0 (off) <sup>(1)</sup>	0 (unlocked)	1 (unlocked)	Read only	NA	All
1 (on)	0 (off)	1 (locked)	2 (locked)	Read only	Physical	Function Blocks only
1 (on)	0 (off)	1 (locked)	2 (locked)	Read only	Everything	None

<sup>(1)</sup> The hardware and software write lock select bits are mutually exclusive and the hardware select has the highest priority. When the HW\_SEL bit is set to 1 (on), the SW\_SEL bit is automatically set to 0 (off) and is read only.

## FEATURES\_SEL

FEATURES\_SEL is used to turn on any of the supported features. The default setting of the 3144P does not select any of these features. Choose one of the supported features if any.



## PlantWeb™ Alerts

### MAX\_NOTIFY

The MAX\_NOTIFY parameter value is the maximum number of alert reports that the resource can have sent without getting a confirmation, corresponding to the amount of buffer space available for alert messages. The number can be set lower, to control alert flooding, by adjusting the LIM\_NOTIFY parameter value. If LIM\_NOTIFY is set to zero, then no alerts are reported.

The alerts and recommended actions should be used in conjunction with "Operation" on page 4-20.

The Resource Block will act as a coordinator for PlantWeb alerts. There will be three alarm parameters (FAILED\_ALARM, MAINT\_ALARM, and ADVISE\_ALARM) which will contain information regarding some of the device errors which are detected by the transmitter software. There will be a RECOMMENDED\_ACTION parameter which will be used to display the recommended action text for the highest priority alarm and a HEALTH\_INDEX parameters (0 - 100) indicating the overall health of the transmitter. FAILED\_ALARM will have the highest priority followed by MAINT\_ALARM and ADVISE\_ALARM will be the lowest priority.

### FAILED\_ALARMS

A failure alarm indicates a failure within a device that will make the device or some part of the device non-operational. This implies that the device is in need of repair and must be fixed immediately. There are five parameters associated with FAILED\_ALARMS specifically, they are described below.

#### *FAILED\_ENABLED*

This parameter contains a list of failures in the device which makes the device non-operational that will cause an alert to be sent. Below is a list of the failures with the highest priority first.

1. Electronics
2. NV Memory
3. HW / SW Incompatible
4. Primary Value
5. Secondary Value

#### *FAILED\_MASK*

This parameter will mask any of the failed conditions listed in FAILED\_ENABLED. A bit on means that the condition is masked out from alarming and will not be reported.

#### *FAILED\_PRI*

Designates the alerting priority of the FAILED\_ALM, see "Alarm Priority" on page 4-18. The default is 0 and the recommended value are between 8 and 15.

#### *FAILED\_ACTIVE*

This parameter displays which of the alarms is active. Only the alarm with the highest priority will be displayed. This priority is not the same as the FAILED\_PRI parameter described above. This priority is hard coded within the device and is not user configurable.

#### *FAILED\_ALM*

Alarm indicating a failure within a device which makes the device non-operational.

**MAINT\_ALARMS**

A maintenance alarm indicates the device or some part of the device needs maintenance soon. If the condition is ignored, the device will eventually fail. There are five parameters associated with MAINT\_ALARMS, they are described below.

*MAINT\_ENABLED*

The MAINT\_ENABLED parameter contains a list of conditions indicating the device or some part of the device needs maintenance soon.

Below is a list of the conditions with the highest priority first.

1. Primary Value Degraded
2. Secondary Value Degraded
3. Configuration Error
4. Calibration Error

*MAINT\_MASK*

The MAINT\_MASK parameter will mask any of the failed conditions listed in MAINT\_ENABLED. A bit on means that the condition is masked out from alarming and will not be reported.

*MAINT\_PRI*

MAINT\_PRI designates the alarming priority of the MAINT\_ALM, "Process Alarms" on page 4-17. The default is 0 and the recommended values is 3 to 7.

*MAINT\_ACTIVE*

The MAINT\_ACTIVE parameter displays which of the alarms is active. Only the condition with the highest priority will be displayed. This priority is not the same as the MAINT\_PRI parameter described above. This priority is hard coded within the device and is not user configurable.

*MAINT\_ALM*

An alarm indicating the device needs maintenance soon. If the condition is ignored, the device will eventually fail.

**Advisory Alarms**

An advisory alarm indicates informative conditions that do not have a direct impact on the device's primary functions. There are five parameters associated with ADVISE\_ALARMS, they are described below.

*ADVISE\_ENABLED*

The ADVISE\_ENABLED parameter contains a list of informative conditions that do not have a direct impact on the device's primary functions. Below is a list of the advisories with the highest priority first.

1. NV Writes Deferred
2. SPM Process Anomaly detected

*ADVISE\_MASK*

The ADVISE\_MASK parameter will mask any of the failed conditions listed in ADVISE\_ENABLED. A bit on means the condition is masked out from alarming and will not be reported.

*ADVISE\_PRI*

ADVISE\_PRI designates the alarming priority of the ADVISE\_ALM, see "Process Alarms" on page 4-17. The default is 0 and the recommended values are 1 or 2.

**ADVISE\_ACTIVE**

The ADVISE\_ACTIVE parameter displays which of the advisories is active. Only the advisory with the highest priority will be displayed. This priority is not the same as the ADVISE\_PRI parameter described above. This priority is hard coded within the device and is not user configurable.

**ADVISE\_ALM**

ADVISE\_ALM is an alarm indicating advisory alarms. These conditions do not have a direct impact on the process or device integrity.

**Recommended Actions for PlantWeb Alerts**

Table 4-2.  
RB.RECOMMENDED\_ACTION

**RECOMMENDED\_ACTION**

The RECOMMENDED\_ACTION parameter displays a text string that will give a recommended course of action to take based on which type and which specific event of the PlantWeb alerts are active.

Alarm Type	Failed/Maint/Advise Active Event	Recommended Action Text String
None	None	No action required
Advisory	NV Writes Deferred	Non-volatile writes have been deferred, leave the device powered until the advisory goes away
Maintenance	Configuration Error Primary Value Degraded	Re-write the Sensor Configuration Confirm the operating range of the applied sensor and/or verify the sensor connection and device environment
	Calibration Error Secondary Value Degraded	Retrim the device Verify the ambient temperature is within operating limits
Failed	Electronics Failure HW / SW Incompatible	Replace the Device Verify the Hardware Revision is compatible with the Software Revision
	NV Memory Failure	Reset the device then download the Device Configuration
	Primary Value Failure	Verify the instrument process is within the Sensor range and / or confirm sensor configuration and wiring.
Diagnostic Error	Secondary Value Failure	Verify the ambient temperature is within operating limits
	Sensor Drift Alarm or Hot BU active	Verify sensor range and/or confirm sensor configuration and wiring.

FOUNDATION Fieldbus

**Resource Block Diagnostics**

Table 4-3. Resource Block BLOCK\_ERR messages

**Block Errors**

Table 4-3 lists conditions reported in the BLOCK\_ERR parameter.

Condition Name and Description
<b>Other</b>
<b>Device Needs Maintenance Now</b>
<b>Memory Failure:</b> A memory failure has occurred in FLASH, RAM, or EEPROM memory
<b>Lost NV Data:</b> Non-volatile data that is stored in non-volatile memory has been lost.
Device Needs Maintenance Now
<b>Out of Service:</b> The actual mode is out of service.

## Rosemount 3144P

Table 4-4. Resource Block SUMMARY\_STATUS messages

Condition Name
No repair needed
Repairable
Call Service Center

Table 4-5. Resource Block RB.DETAILED\_STATUS

RB.DETAILED_STATUS	Description
Sensor Transducer block error.	Active when any SENSOR_DETAILED_STAUS bit is on
Manufacturing Block integrity error	The manufacturing block size, revision, or checksum is wrong
Hardware/software incompatible	Verify the manufacturing block revision and the hardware revision are correct/compatible with the software revision.
Non-volatile memory integrity error	Invalid checksum on a block of NV data
ROM integrity error	Invalid application code checksum
Lost deferred NV data	Device has been power-cycled while non-volatile writes were being deferred to prevent premature memory failure, the write operations have been deferred.
NV Writes Deferred	A high number of writes has been detected to non-volatile memory. To prevent premature failure, the write operations have been deferred.

## SENSOR TRANSDUCER BLOCK

### NOTE

When the engineering units of the XD\_SCALE in the associated AI Block are selected, the engineering units in the Transducer Block change to the same units. THIS IS THE ONLY WAY TO CHANGE THE ENGINEERING UNITS IN THE SENSOR TRANSDUCER BLOCK.

## Damping

⚠ The damping parameter in the Transducer Block may be used to filter measurement noise. By increasing the damping time, the transmitter will have a slower response time, but will decrease the amount of process noise that is translated to the Transducer Block Primary Value. Because both the LCD and AI Block get input from the Transducer Block, adjusting the damping parameter will effect the values passed to both blocks.

### NOTE

The AI Block has it's own filtering parameter called PV\_FTIME. For simplicity, it is better to do filtering in the Transducer Block as damping will be applied to primary value on every sensor update. If filtering is done in AI block, damping will be applied to output every macrocycle. The LCD will display value from Transducer block.

## Sensor Transducer Block Diagnostics

Table 4-6. Sensor Transducer Block BLOCK\_ERR messages

Condition Name and Description
Other
<b>Out of Service:</b> The actual mode is out of service.

Table 4-7. Sensor Transducer Block XD\_ERR messages

Condition Name and Description
<b>Electronics Failure:</b> An electrical component failed.
<b>I/O Failure:</b> An I/O failure occurred.
<b>Software Error:</b> The software has detected an internal error.
<b>Calibration Error:</b> An error occurred during calibration of the device.
<b>Algorithm Error:</b> The algorithm used in the transducer block produced an error due to overflow, data reasonableness failure, etc.

Table 4-8 lists the potential errors and the possible corrective actions for the given values. The corrective actions are in order of increasing system level compromises. The first step should always be to reset the transmitter and then if the error persists, try the steps in Table 4-8. Start with the first corrective action and then try the second.

Table 4-8. Sensor Transducer Block STB.SENSOR\_DETAILED\_STATUS messages

STB.SENSOR_DETAILED_STATUS	Description
Invalid Configuration	Wrong sensor connection with wrong sensor type
ASIC RCV Error	The micro detected a chksum or start/stop bit failure with ASIC communication
ASIC TX Error	The ASIC detected a communication error
ASIC Interrupt Error	ASIC interrupts are too fast or slow
Reference Error	Reference resistors are greater than 25% of known value
ASIC Configuration Error	ASIC registers were not written correctly. (Also CALIBRATION_ERR)
Sensor Open	Open sensor detected
Sensor Shorted	Shorted sensor detected
Terminal Temperature Failure	Open or shorted PRT detected
Sensor Out of Operating Range	Sensor readings have gone beyond PRIMARY_VALUE_RANGE values
Sensor beyond operating limits	Sensor readings have gone below 2% of lower range or above 6% of upper range of sensor.
Terminal Temperature Out of Operating Range	PRT readings have gone beyond SECONDARY_VALUE_RANGE values
Terminal Temperature Beyond Operating Limits	PRT readings have gone below 2% of lower range or above 6% of upper range of PRT. (These ranges are calculated and are not the actual range of the PRT which is a PT100 A385)
Sensor Degraded	For RTDs, this is excessive EMF detected.
Calibration Error	The user trim has failed due to excessive correction or sensor failure during the trim method

FOUNDATION Fieldbus

## LCD TRANSDUCER BLOCK

The LCD display connects directly to the 3144P electronics FOUNDATION fieldbus output board. The meter indicates output and abbreviated diagnostic messages.

The first line of five characters displays the sensor being measured.

If the measurement is in error, "Error" appears on the first line. The second line indicates if the device or the sensor is causing the error.

Each parameter configured for display will appear on the LCD for a brief period before the next parameter is displayed. If the status of the parameter goes bad, the LCD will also cycle diagnostics following the displayed variable:

# Rosemount 3144P

## Custom Meter Configuration

Shipped from the factory, Parameter #1 (sensor 1) is configured to display the Primary Variable (temperature) from the LCD Transducer Block. When shipping with dual sensors, sensor 2 will be configured to display To change the configuration of Parameter #1, #2, or to configure additional parameters use the configuration parameters below. The LCD Transducer Block can be configured to sequence four different process variables as long as the parameters are sourced from a function block that is scheduled to execute within the 3144P temperature transmitter. If a function block is scheduled in the 3144P that links a process variable from another device on the segment, that process variable can be displayed on the LCD.

### DISPLAY\_PARAM\_SEL

The DISPLAY\_PARAM\_SEL parameter specifies how many process variables will be displayed. Select up to four display parameters.

### BLK\_TAG\_#<sup>(1)</sup>

Enter the Block Tag of the function block that contains the parameter to be displayed. The default function block tags from the factory are:

TRANSDUCER  
AI 1400, 1500, 1600  
PID 1700 and 1800  
ISEL 1900  
CHAR 2000  
ARTH 2100  
Output Splitter OSPL 2200

### BLK\_TYPE\_#<sup>(1)</sup>

Enter the Block Type of the function block that contains the parameter to be displayed. This parameter is generally selected via a drop-down menu with a list of possible function block types. (e.g. Transducer, PID, AI, etc.)

### PARAM\_INDEX\_#<sup>(1)</sup>

The PARAM\_INDEX\_# parameter is generally selected via a drop-down menu with a list of possible parameter names based upon what is available in the function block type selected. Choose the parameter to be displayed.

### CUSTOM\_TAG\_#<sup>(1)</sup>

The CUSTOM\_TAG\_# is an optional user-specified tag identifier that can be configured to be displayed with the parameter in place of the block tag. Enter a tag of up to five characters.

### UNITS\_TYPE\_#<sup>(1)</sup>

The UNITS\_TYPE\_# parameter is generally selected via a drop-down menu with three options: AUTO, CUSTOM, or NONE. Select AUTO only when the parameter to be displayed is pressure, temperature, or percent. For other parameters, select CUSTOM and be sure to configure the CUSTOM\_UNITS\_# parameter. Select NONE if the parameter is to be displayed without associated units.

### CUSTOM\_UNITS\_#<sup>(1)</sup>

Specify custom units to be displayed with the parameter. Enter up to six characters. To display Custom Units the UNITS\_TYPE\_# must be set to CUSTOM.

(1) # represents the specified parameter number.

**Self Test Procedure for the LCD**

The SELF\_TEST parameter in the Resource block will test LCD segments. When running, the segments of the display should light up for about five seconds.

If your host system supports methods refer to your host documentation on how to run the "Self Test" method. If your host system does not support methods than you can run this test manually be following the steps below.

1. Put Resource block into "OOS" (Out of Service).
2. Go to the parameter called "SELF\_TEST" and write the value Self test (0x2).
3. Observe the LCD screen when you are doing this. All of the segments should light up.
4. Put the Resource block back into "AUTO".

**LCD Transducer Block Diagnostics**

Table 4-9. LCD Transducer Block BLOCK\_ERR messages

Condition Name and Description
Other
<b>Out of Service:</b> The actual mode is out of service.

Symptom	Possible Causes	Recommended Action
The LCD displays "DSPLY#INVALID." Read the BLOCK_ERR and if it says "BLOCK CONFIGURATION" perform the Recommended Action	One or more of the display parameters are not configured properly.	See "LCD Transducer Block" on page 2-16.
The Bar Graph and the AI.OUT readings do not match.	The OUT_SCALE of the AI block is not configured properly.	See "Analog Input (AI) Function Block" on page 2-9 and "Display bar graph" on page 2-18.
"3144P" is being displayed or not all of the values are being displayed.	The LCD block parameter "DISPLAY_PARAMETER_SELECT is not properly configured.	See "LCD Transducer Block" on page 2-16.
The display reads OOS	The resource and or the LCD Transducer block are OOS.	Verify that both blocks are in "AUTO,"
The display is hard to read.	Some of the LCD segments may have gone bad. Device is out o the temperature limit for the LCD. (-20 to 85 °C)	See XXXX (Self Test). If some of the segment is bad, replace the LCD. Check ambient temperature of the device.

FOUNDATION Fieldbus

# Rosemount 3144P

## ANALOG INPUT (AI)

### Simulation

Simulate replaces the channel value coming from the Sensor Transducer Block. For testing purposes, it is possible to manually drive the output of the Analog Input Block to a desired value. There are two ways to do this.

#### Manual Mode

To change only the OUT\_VALUE and not the OUT\_STATUS of the AI Block, place the TARGET MODE of the block to MANUAL. Then, change the OUT\_VALUE to the desired value.

#### Simulate

1. If the SIMULATE switch is in the OFF position, move it to the ON position. If the SIMULATE jumper is already in the ON position, you must move it to off and place it back in the ON position.

#### NOTE

As a safety measure, the switch must be reset every time power is interrupted to the device in order to enable SIMULATE. This prevents a device that is tested on the bench from getting installed in the process with SIMULATE still active.

2. To change both the OUT\_VALUE and OUT\_STATUS of the AI Block, set the TARGET MODE to AUTO.
3. Set SIMULATE\_ENABLE\_DISABLE to 'Active'.
4. Enter the desired SIMULATE\_VALUE to change the OUT\_VALUE and SIMULATE\_STATUS\_QUALITY to change the OUT\_STATUS. If errors occur when performing the above steps, be sure that the SIMULATE jumper has been reset after powering up the device.

### Configure the AI block

⚠ A minimum of four parameters are required to configure the AI Block. The parameters are described below with example configurations shown at the end of this section.

#### CHANNEL

Select the channel that corresponds to the desired sensor measurement. .

Channel	Measurement
1	Input 1
2	Input 2
3	$\Delta T$
4	Body Temperature

#### L\_TYPE

The L\_TYPE parameter defines the relationship of the sensor measurement (sensor temperature) to the desired output temperature of the AI Block. The relationship can be direct or indirect.

##### *Direct*

Select direct when the desired output will be the same as the sensor measurement (sensor temperature).



*Indirect*

Select indirect when the desired output is a calculated measurement based on the sensor measurement (e.g. ohm or mV). The relationship between the sensor measurement and the calculated measurement will be linear.

**XD\_SCALE and OUT\_SCALE**

The XD\_SCALE and OUT\_SCALE each include four parameters: 0%, 100%, engineering units, and precision (decimal point). Set these based on the L\_TYPE:

*L\_TYPE is Direct*

When the desired output is the measured variable, set the XD\_SCALE to represent the operating range of the process. Set OUT\_SCALE to match XD\_SCALE.

*L\_TYPE is Indirect*

When an inferred measurement is made based on the sensor measurement, set the XD\_SCALE to represent the operating range that the sensor will see in the process. Determine the inferred measurement values that correspond to the XD\_SCALE 0 and 100% points and set these for the OUT\_SCALE.

**NOTE**

To avoid configuration errors, only select Engineering Units for XD\_SCALE and OUT\_SCALE that are supported by the device. The supported units are:

Temperature (Channel 1 and 2)	Terminal Temperature
°C	°C
°F	°F
°K	K
°R	R
Ω	
mV	

When the engineering units of the XD\_SCALE are selected, this causes the engineering units of the PRIMARY\_VALUE\_RANGE in the Transducer Block to change to the same units. THIS IS THE ONLY WAY TO CHANGE THE ENGINEERING UNITS IN THE SENSOR TRANSDUCER BLOCK, PRIMARY\_VALUE\_RANGE parameter.

**Configuration Examples**

Sensor Type: 4-wire, Pt 100  $\alpha = 385$ .  
 Desired measurement process temperature in the -200 to 500 °F range.  
 Monitor the transmitter electronics temperature in the -40 to 185 °F. range

*Transducer Block*

If Host System Supports Methods:

1. Click on Methods
2. Choose Sensor Connections<sup>(1)</sup>
3. Follow on-screen instruction to setup Sensor 1 as a 4-wire, Pt 100  $\alpha = 385$ .

If Host System Does Not Support Methods:

1. Put transducer block into OOS mode.
  - a. Go to MODE\_BLK.TARGET
  - b. Choose OOS (0x80)
2. Go to SENSOR\_CONNECTION.
  - a. Choose 4-wire (0x4)
3. Go to SENSOR\_TYPE.
  - a. Choose PT100A385
4. Put the transducer block back into Auto mode.

AI Blocks (Basic Configuration)

AI1 as Process Temperature

1. Put the AI Block into OOS mode.
  - a. Go to MODE\_BLK.TARGET
  - b. Choose OOS (0x80)
2. Go to CHANNEL
  - a. Choose Sensor 1
3. Go to L\_TYPE
  - a. Choose Direct
4. Go to XD\_Scale
  - a. Choose UNITS\_INDEX to be °F
  - b. Set 0% = -200, set 100% = 500
5. Go to OUT\_SCALE
  - a. Choose UNITS\_INDEX to be °F
  - b. Set the 0 and 100 scale to be the same as in Step 4b.
6. Put the AI Block back into Auto mode.
7. Follow Host Procedure to download schedule into Block.

(1) Some choices may not be available due to the current configuration of the device.

Examples:

1) Sensor 2 cannot be configured at all if Sensor 1 is set up as a 4-wire sensor

2) If Sensor 2 is configured, Sensor 1 can not be set up as a 4-wire sensor (and vise-versa)

3) When selecting a thermocouple as the sensor type, a 3- or 4-wire connection cannot be selected.

In this situation, configure the other sensor as "Not used." This will clear the dependencies that are preventing the configuration of the desired sensor.

AI2 as Terminal Temperature (body temperature)

1. Put the AI Block into OOS mode.
  - a. Go to MODE\_BLK.TARGET
  - b. Choose OOS (0x80)
2. Go to CHANNEL
  - a. Choose Body Temperature
3. Go to L\_TYPE
  - a. Choose Direct
4. Go to XD\_Scale
  - a. Choose UNITS\_INDEX to be °F
  - b. Set 0% = -40, set 100% = 185
5. Go to OUT\_SCALE
  - a. Choose UNITS\_INDEX to be °F
  - b. Set the 0 and 100 scale to be the same as in step 4b.
6. Put the AI Block back into Auto mode.
7. Follow Host Procedure to download schedule into Block.

## Filtering

### NOTE

If damping has already been configured in the Transducer Block, setting a non-zero value for PV\_FTIME will add to that damping.

⚠ The filtering feature changes the response time of the device to smooth variations in output readings caused by rapid changes in input. Adjust the filter time constant (in seconds) using the PV\_FTIME parameter. Set the filter time constant to zero to disable the filter feature.

## Process Alarms

Process Alarm detection is based on the OUT value. Configure the alarm limits of the following standard alarms:

- High (HIGH\_LIM)
- High high (HIGH\_HIGH\_LIM)
- Low (LOW\_LIM)
- Low low (LOW\_LOW\_LIM)

In order to avoid alarm chattering when the variable is oscillating around the alarm limit, an alarm hysteresis in percent of the PV span can be set using the ALARM\_HYS parameter. The priority of each alarm is set in the following parameters:

- HIGH\_PRI
- HIGH\_HIGH\_PRI
- LOW\_PRI
- LOW\_LOW\_PRI

## Status

### Alarm Priority

Alarms are grouped into five levels of priority:

Priority Number	Priority Description
0	The alarm condition is not used.
1	An alarm condition with a priority of 1 is recognized by the system, but is not reported to the operator.
2	An alarm condition with a priority of 2 is reported to the operator.
3-7	Alarm conditions of priority 3 to 7 are advisory alarms of increasing priority.
8-15	Alarm conditions of priority 8 to 15 are critical alarms of increasing priority.

When a PV is passed from one function block to another, it passes a STATUS along with the PV. The STATUS can be: GOOD, BAD, or UNCERTAIN. When a fault occurs in the device, the PV will lock at the last value that had a STATUS of GOOD and the STATUS will change from GOOD to BAD or from GOOD to UNCERTAIN. It is important that the control strategy that uses the PV also monitors the STATUS to take appropriate action when the STATUS changes from GOOD to either BAD or UNCERTAIN.

### Status Options

Status Options (STATUS\_OPTS) supported by the AI block are shown below:

#### Propagate Fault Forward

If the status from the sensor is Bad, Device failure or Bad, Sensor failure, propagate it to OUT without generating an alarm. The use of these sub-status in OUT is determined by this option. Through this option, the user may determine whether alarming (sending of an alert) will be done by the block or propagated downstream for alarming.

#### Uncertain if Limited

Set the output status of the Analog Input block to uncertain if the measured or calculated value is limited.

#### BAD

Set the output status to Bad if the sensor is violating a high or low limit.

#### Uncertain if Man Mode

Set the output status of the Analog Input block to uncertain if the actual mode of the block is Man.

---

#### NOTE

The instrument must be in Out of Service mode to set the status option.

---

## Advanced Features

The following parameters provide the capabilities to drive a discrete output alarm in the event that a process alarm (HI\_HI\_LIM, HI\_LIM, LO\_LO\_LIM, LO\_LIM) has been exceeded.

### ALARM\_TYPE

ALARM\_TYPE allows one or more of the process alarm conditions (HI\_HI\_LIM, HI\_LIM, LO\_LO\_LIM, LO\_LIM) detected by the AI function block to be used in setting its OUT\_D parameter.

### OUT\_D

OUT\_D is the discrete output of the AI function block based on the detection of process alarm condition(s). This parameter may be linked to other function blocks that require a discrete input based on the detected alarm condition.

## Analog Input Diagnostics

Table 4-10. AI BLOCK\_ERR Conditions.

Condition Number	Condition Name and Description
0	Other
1	<b>Block Configuration Error:</b> the selected channel carries a measurement that is incompatible with the engineering units selected in XD_SCALE, the L_TYPE parameter is not configured, or CHANNEL = zero.
3	<b>Simulate Active:</b> Simulation is enabled and the block is using a simulated value in its execution.
7	<b>Input Failure/Process Variable has Bad Status:</b> The hardware is bad, or a bad status is being simulated.
14	<b>Power Up:</b> Block is not scheduled
15	<b>Out of Service:</b> The actual mode is out of service.

Table 4-11. Troubleshooting the AI block

Symptom	Possible Causes	Recommended Actions
Bad or no temperature readings (Read the AI "BLOCK_ERR" parameter)	BLOCK_ERR reads OUT OF SERVICE (OOS)	1. AI Block target mode target mode set to OOS. 2. Resource Block OUT OF SERVICE.
	BLOCK_ERR reads CONFIGURATION ERROR	1. Check CHANNEL parameter (see "CHANNEL" on page 2-9) 2. Check L_TYPE parameter (see "L_TYPE" on page 2-9) 3. Check XD_SCALE engineering units. (see "XD_SCALE and OUT_SCALE" on page 2-10)
	BLOCK_ERR reads POWERUP	Download Schedule into block. Refer to host for downloading procedure.
	BLOCK_ERR reads BAD INPUT	1. Sensor Transducer Block Out Of Service (OOS) 2. Resource Block Out of Service (OOS)
	No BLOCK_ERR but readings are not correct. If using Indirect mode, scaling could be wrong.	1. Check XD_SCALE parameter. 2. Check OUT_SCALE parameter. (see "XD_SCALE and OUT_SCALE" on page 2-10)
	No BLOCK_ERR. Sensor needs to be calibrated or Zero trimmed.	See Section 3: Operation and Maintenance to determine the appropriate trimming or calibration procedure.
OUT parameter status reads UNCERTAIN and substatus reads EngUnitRangViolation.	Out_ScaleEU_0 and EU_100 settings are incorrect.	See "XD_SCALE and OUT_SCALE" on page 2-10.

# Rosemount 3144P

## OPERATION

### Overview

This section contains information on operation and maintenance procedures.

### METHODS AND MANUAL OPERATION

Each FOUNDATION fieldbus host or configuration tool has different ways of displaying and performing operations. Some hosts will use DD Methods to complete device configuration and will display data consistently across platforms. There is no requirement that a host or configuration tool support these features.

In addition, if your host or configuration tool does not support methods this section will cover manually configuring the parameters involved with each method operation. For more detailed information on the use of methods, see your host or configuration tool manual.

FOUNDATION Fieldbus

### Trim the Transmitter

Calibrating the transmitter increases the precision of your measurement system. The user may use one or more of a number of trim functions when calibrating. The trim functions allow the user to make adjustments to the factory-stored characterization curve by digitally altering the transmitter's interpretation of the sensor input.

Figure 4-1. Trim

*Application:* Linear Offset

*Solution:* Single-Point Trim

*Method:*

1. Connect sensor to transmitter. Place sensor in bath between range points.
2. Enter known bath temperature using the 375 Field Communicator.

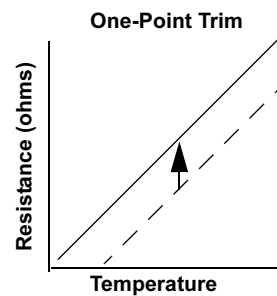

*Application:* Linear Offset and Slope Correction

*Solution:* Two-Point Trim

*Method:*

1. Connect sensor to transmitter. Place sensor in bath at low range point.
2. Enter known bath temperature using the 375 Field Communicator.
3. Repeat at high range point.

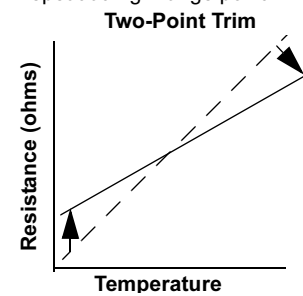

Transmitter System Curve  
Site-Standard Curve

### Sensor Calibration, Lower and Upper Trim Methods

⚠ In order to calibrate the transmitter, run the Lower and Upper Trim Methods. If your system does not support methods, manually configure the Transducer Block parameters listed below.

1. Set MODE\_BLK.TARGET\_X to OOS
2. Set SENSOR\_CAL\_METHOD\_X to User Trim
3. Set CAL\_UNIT\_X to supported engineering units in the Transducer Block
4. Apply temperature that corresponds to the lower calibration point and allow the temperature to stabilize. The temperature must be between the range limits defined in PRIMARY\_VALUE\_RANGE\_X.
5. Set values of CAL\_POINT\_LO\_X to correspond to the temperature applied by the sensor.
6. Apply temperature, temperature corresponding to the upper calibration
7. Allow temperature to stabilize.
8. Set CAL\_POINT\_HI\_X

#### NOTE

CAL\_POINT\_HI\_X must be within PRIMARY\_VALUE\_RANGE\_X and greater than CAL\_POINT\_LO\_X + CAL\_MIN\_SPAN\_X.

9. Set SENSOR\_CAL\_DATE\_X to the current date.
10. Set SENSOR\_CAL\_WHO\_X to the person responsible for the calibration.
11. Set SENSOR\_CAL\_LOC\_X to the calibration location.
12. Set MODE\_BLK.TARGET\_X to AUTO

#### NOTE

If trim fails the transmitter will automatically revert to factory trim. Excessive correction or sensor failure could cause device status to read "calibration error." To clear this, trim the transmitter

### Recall Factory Trim

⚠ To recall a factory trim on the transmitter, run the Recall Factory Trim. If your system does not support methods, manually configure the Transducer Block parameters listed below.

1. Set MODE\_BLK.TARGET\_X to OOS
2. Set SENSOR\_CAL\_METHOD\_X to Factory Trim.
3. Set SET\_FACTORY\_TRIM\_X to Recall.
4. Set SENSOR\_CAL\_DATE\_X to the current date.
5. Set SENSOR\_CAL\_WHO\_X to the person responsible for the calibration.
6. Set SENSOR\_CAL\_LOC\_X to the calibration location.
7. Set MODE\_BLK.TARGET\_X to AUTO.

#### NOTE

When changing the sensor type, the transmitter reverts to the factory trim and any other trim performed on the transmitter is lost.

## Statistical Process Monitoring (SPM)

Statistical Process Monitoring algorithm is intended to provide basic information regarding the behavior of process measurements such as PID control block and actual valve position. The algorithm can monitor up to four user selected variables. All variables must reside in a scheduled function block which is contained in the device. This algorithm can perform higher levels of diagnostics by distribution of computational power to field devices. The two statistical parameters monitored by the Statistical Process Monitoring are mean and standard deviation. By using the mean and standard deviation, the process or control levels and dynamics can be monitored for change over time. The algorithm also provides:

- Configurable limits/alarms for High variation, low dynamics, and mean changes with respect to the learned levels
- Necessary statistical information for Regulatory Control Loop Diagnostics, Root Cause Diagnostics, and Operations Diagnostics.

### NOTE

In Fieldbus devices, a wealth of information is available to the user. Both process measurement and control is feasible at the device level. The devices themselves contain both the process measurements and control signals that are necessary to not only control the process, but to determine if the process and control is healthy. By looking at the process measurement data and control output over time, one can gain additional insight into the process. Under some load conditions and process demands, changes could be interpreted as degradation of instruments, valves or major components such as pumps, compressors, heat exchangers, etc.... This degradation may also indicate that the loop control scheme needs to be re-tuned or re-evaluated. By learning a healthy process and continually comparing current information to the known healthy information, problems due to degradation and eventual failure can be avoided and remedied ahead of time. These diagnostics are to aid in the engineering and maintenance of the devices. False alarms and missed detections may occur. If a reoccurring problem in your process exists, please contact Rosemount for assistance with the diagnostics.

### Configuration Phase

The configuration phase is an inactive state when the SPM algorithm can be configured. In this phase, the block tags, block type, parameter, limits for high variation, low dynamics, and mean change detection can be set by the user. The "Statistical Process Monitoring Activation" parameter must be set to "disabled" to configure any SPM parameter. SPM can monitor any linkable input or output parameter of a scheduled function block that resides in the device.

### Learning Phase

In the learning phase of Statistical Process Monitoring, the algorithm establishes a baseline of the mean and dynamics of a Statistical Process Monitoring variable. The baseline data is compared to current data for calculating any changes in mean or dynamics of the Statistical Process Monitoring variables.



## SPM Configuration

### Monitoring Phase

The monitoring phase starts after the learning process is complete. The algorithm compares the current values to the baseline values of the mean and standard deviation. During this phase the algorithm computes the percent change in mean and standard deviation to determine if the defined limits are violated.

### SPM\_Bypass\_Verification

If "Yes" the verification of the baseline is turned off. If "No" the learned baseline is compared to the next current calculated value to ensure a good baseline value. The recommended value is NO.

### SPM\_Monitoring\_Cycle

SPM\_Monitoring\_Cycle is the length of time the process values are taken and used in each calculation. A longer monitoring cycle may provide a more stable mean value. The default is 15 minutes.

### SPM#\_Block\_Tag

Enter the Block Tag of the function block that contains the parameter to be monitored. Block tag must be entered, there is no pull-down menu to select the tag. The tag must be a valid "Block Tag" that is in the device. The default block tags from the factory are:

AI 1400  
AI 1500  
PID 1600  
ISEL 1700  
CHAR 1800  
ARITH 1900

SPM can also monitor "out" parameters from other devices. To do this, link the "out" parameter to an input parameter of a function block that resides in the device, and set up SPM to monitor the input parameter.

### SPM#\_Block Type

Enter the Block Type of the function block that contains the parameter to be monitored.

### SPM#\_Parameter Index

Enter the Parameter Index of the parameter to be monitored.



### **SPM#\_Thresholds**

The SPM#\_Thresholds are used to allow alerts to be sent when the values are beyond the threshold values that have been set for each parameter.

#### **Mean Limit**

Alert Limit value in percent change of the Mean compared with the baseline mean value.

#### **High Variation**

Alert Limit value in percent change of the Stdev compared with the baseline Stdev value.

#### **Low Dynamics**

Alert Limit value in percent change of the Stdev compared with the baseline Stdev value.

### **SPM\_Active**

SPM\_Active parameter that starts the Statistical Process Monitoring when "Enabled". "Disabled" turns the diagnostic monitoring off. Must be set to "Disabled" for configuration. Only set to "Enabled" after fully configuring the SPM.

### **SPM#\_User Command**

Select "Learn" after all the parameters have been configured to begin the Learning Phase. The monitoring phase will start after the learning process is complete. Select "Quit" to stop the SPM "Detect" may be selected to return to the monitoring phase.

### **Baseline Values**

The Baseline Values are the calculated values from the process over the Learning Cycle.

#### **SPM#\_Baseline\_Mean**

SPM#\_Baseline\_Mean is the calculated average of the process variable over the Learning Cycle.

#### **SPM#\_Baseline\_Standard\_Deviation**

SPM#\_Baseline\_Standard\_Deviation is the square root of the variance of the process variable over the Learning Cycle.

### TROUBLESHOOTING GUIDES

Figure 4-2. 3144P troubleshooting flowchart

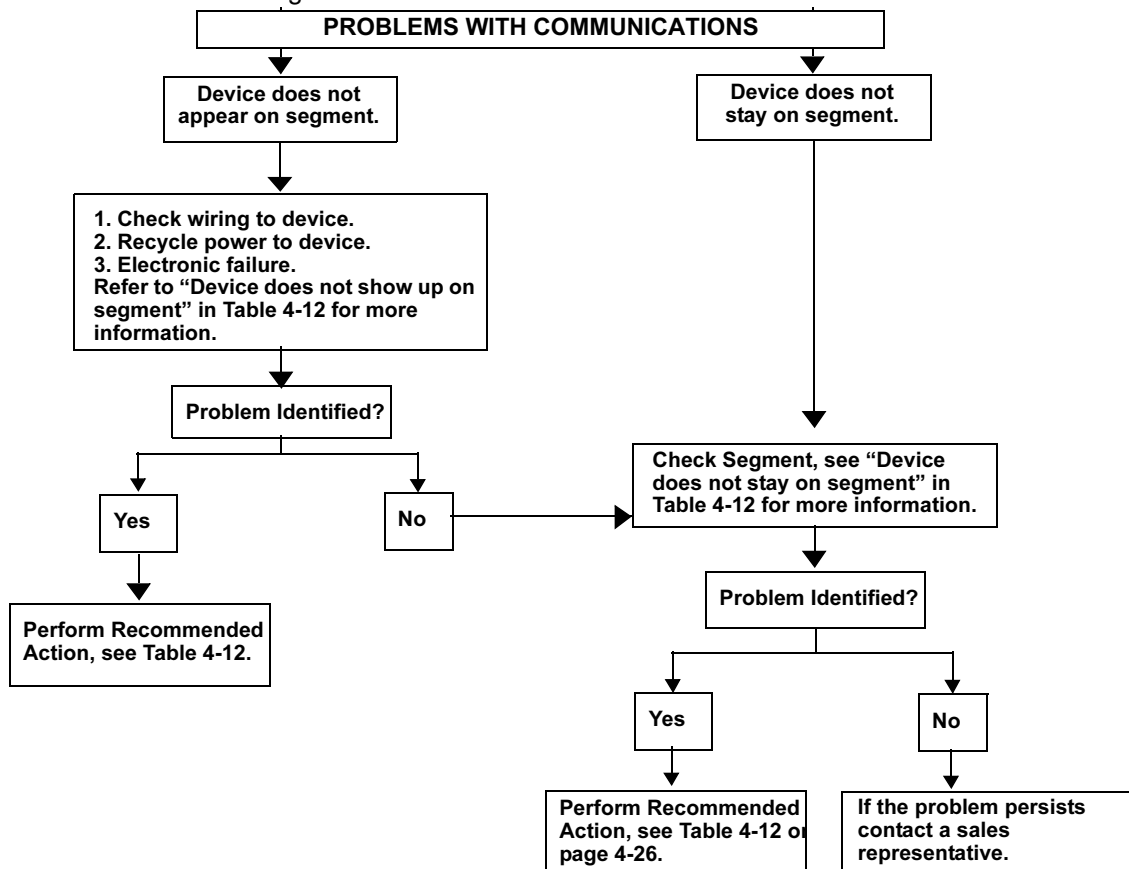

FOUNDATION Fieldbus

## Rosemount 3144P

Table 4-12. Troubleshooting guide

Symptom <sup>(1)</sup>	Cause	Recommended Actions
Device does not show up on segment	Unknown	Recycle power to device
	No power to device	1. Ensure the device is connected to the segment. 2. Check voltage at terminals. There should be 9–32Vdc. 3. Check to ensure the device is drawing current. There should be approximately 11 mA.
	Segment problems	Check wiring (see Figure 2-12 on page 2-13)
	Electronics failing	1. Replace device.
Device does not stay on segment <sup>(2)</sup>	Incompatible network settings	Change host network parameters. Refer to host documentation for procedure.
	Incorrect signal levels.	1. Check for two terminators.
	Refer to host documentation for procedure.	2. Excess cable length.
	Excess noise on segment.	3. Bad Power supply or conditioner
	Refer to host documentation for procedure.	1. Check for incorrect grounding. 2. Check for correct shielded wire. 3. Tighten wire connections. 4. Check for corrosion or moisture on terminals. 5. Check for Bad power supply.
	Electronics failing	1. Replace device.
Other	1. Check for water around the transmitter.	

(1) The corrective actions should be done with consultation of your system integrator.

(2) Wiring and installation 31.25 kbit/s, voltage mode, wire medium application guide AG-140 available from the fieldbus Foundation.

Figure 4-3. Problems with communications flowchart

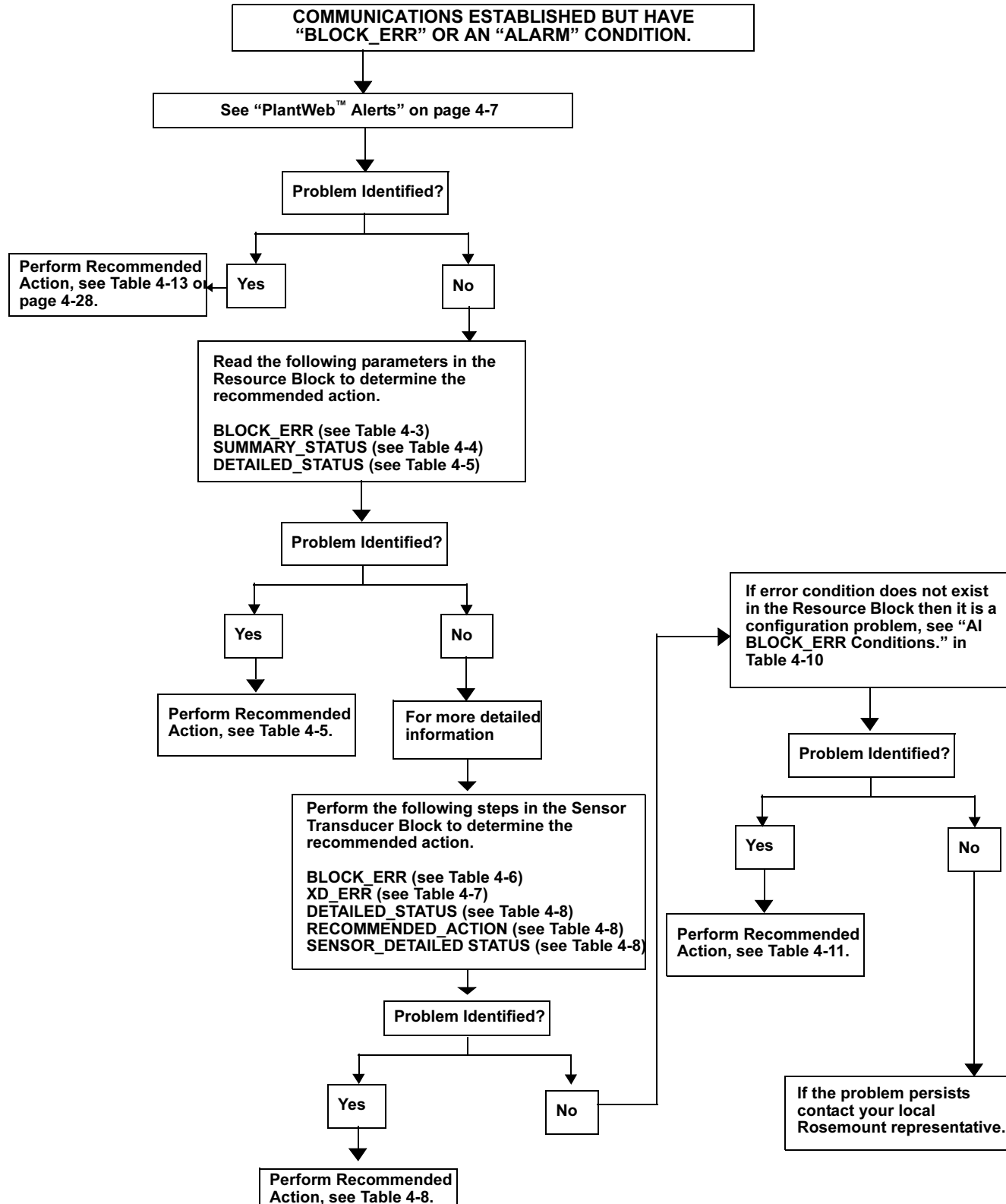

FOUNDATION Fieldbus

## Rosemount 3144P

**FOUNDATION Fieldbus**

If a malfunction is suspected despite the absence of a diagnostics message, follow the procedures described in Table 4-13 to verify that transmitter hardware and process connections are in good working order. Under each of symptoms, specific suggestions are offered for solving problems. Always deal with the most likely and easiest-to-check conditions first.

Table 4-13. FOUNDATION fieldbus Troubleshooting

Symptom	Potential Source	Corrective Action
Transmitter does not Communicate with the Configuration Interface	Loop Wiring	<ul style="list-style-type: none"> <li>Check for adequate voltage to the transmitter. The transmitter requires between 9.0 and 32.0 V at the terminals to operate and provide complete functionality</li> <li>Check for intermittent wire shorts, open circuits, and multiple grounds.</li> </ul>
	Network parameters	<ul style="list-style-type: none"> <li>See page Table 7-2 on page 7-3</li> </ul>
High Output	Sensor Input Failure or Connection	<ul style="list-style-type: none"> <li>Enter the transmitter test mode to isolate a sensor failure.</li> <li>Check for a sensor open circuit.</li> <li>Check the process variable to see if it is out of range.</li> </ul>
	Loop Wiring	<ul style="list-style-type: none"> <li>Check for dirty or defective terminals, interconnecting pins, or receptacles.</li> </ul>
	Electronics Module	<ul style="list-style-type: none"> <li>Enter the transmitter test mode to isolate a module failure.</li> <li>Check the sensor limits to ensure calibration adjustments are within the sensor range.</li> </ul>
Erratic Output	Loop Wiring	<ul style="list-style-type: none"> <li>Check for adequate voltage to the transmitter. The transmitter requires between 9.0 and 32.0 V at the terminals to operate and provide complete functionality</li> <li>Check for intermittent wire shorts, open circuits, and multiple grounds.</li> </ul>
	Electronics Module	<ul style="list-style-type: none"> <li>Enter the transmitter test mode to isolate module failure.</li> </ul>
Low Output or No Output	Sensor Element	<ul style="list-style-type: none"> <li>Enter the transmitter test mode to isolate a sensor failure.</li> <li>Check the process variable to see if it is out of range.</li> </ul>
	Loop Wiring	<ul style="list-style-type: none"> <li>Check for adequate voltage to the transmitter. The transmitter requires between 9.0 and 32.0 V at the terminals to operate and provide complete functionality</li> <li>Check for wire shorts and multiple grounds.</li> <li>Check the loop impedance.</li> <li>Check wire insulation to detect possible shorts to ground.</li> </ul>
	Electronics Module	<ul style="list-style-type: none"> <li>Check the sensor limits to ensure calibration adjustments are within the sensor range.</li> <li>Enter the transmitter test mode to isolate an electronics module failure.</li> </ul>

LCD Display

**NOTE**

The bar graph is not used for Foundation fieldbus devices, nor are the “Sensor 1, Differential, Sensor 2, Multidrop, or Bust Mode” annunciators.”

Table 4-14. LCD Display Error Warning Descriptions

Message	LCD top line	LCD bottom line
<b>RB.DETAILED_STATUS</b>		
Sensor Transducer Block Error	“Error”	“DVICE”
Manufacturing Block Integrity Error	“Error”	“DVICE”
Hardware/Software Incompatible	“Error”	“DVICE”
Non-volatile Memory Integrity Error	“Error”	“DVICE”
ROM Integrity Error	“Error”	“DVICE”
Lost Deferred NV Data	“Error”	“DVICE”
NV Writes Deferred	No Errors Displayed	
ADB Transducer Block Error	No Errors Displayed	
<b>STB.SENSР_DETAILED_STATUS</b>		
Invalid Configuration	“Error”	“SNSOR”
ASIC RCV Error	“Error”	“SNSOR”
ASIC TX Error	“Error”	“SNSOR”
ASIC Interrupt Error	“Error”	“SNSOR”
Reference Error	“Error”	“SNSOR”
ASIC Configuration Error	“Error”	“SNSOR”
Sensor 1 Open	“Error”	“SNSOR”
Sensor 1 Shorted	“Error”	“SNSOR”
Terminal Temperature Failure	“Error”	“SNSOR”
Sensor 1 Out of Operating Range	No Errors Displayed	
Sensor 1 Beyond Operating Limits	“Error”	“SNSOR”
Terminal Temperature Out of Operating Range	No Errors Displayed	
Terminal Temperature Beyond Operating Limits	“Error”	“SNSOR”
Sensor 1 Degraded	“Error”	“SNSOR”
Calibration Error	“Error”	“SNSOR”
Sensor 2 Open	“Error”	“SNSOR”
Sensor 2 Shorted	“Error”	“SNSOR”
Sensor 2 Out of Operating Range	No Errors Displayed	
Sensor 2 Beyond Operating Limits	“Error”	“SNSOR”
Sensor 2 Degraded	“Error”	“SNSOR”
Sensor Drift Alarm	“Error”	“SNSOR”
Hot Backup Active	“Error”	“SNSOR”

FOUNDATION Fieldbus

The following are the default tags for each of the possible Function blocks which display data on the LCD

Block Name	LCD bottom line
Transducer	“TRANS”
AI 1400	“AI 14”
AI 1500	“AI 15”
AI 1600	“AI 16”
PID 1700	“PID 1”
PID 1800	“PID 1”
ISEL 1900	“ISEL”
CHAR 2000	“CHAR”
ARITH 2100	“ARITH”
OSPL 2200	“OSPL”

All other custom tags that are entered must be: numbers 0 - 9, letters A - Z, and/or spaces.

The following are the standard temperature units codes displayed on the LCD:

Units	LCD bottom line
Degrees C	"DEG C"
Degrees F	"DEG F"
Degrees K	"DEG K"
Degrees R	"DEG R"
Ohms	"OHMS"
Millivolts	"MV"
Percent (%)	Uses the percent annunciator

All other custom units that are entered must be: numbers 0 - 9, letters A - Z, and/or spaces.

If the value of the process variable displayed has a bad or uncertain status the following is shown:

Status	LCD bottom line
Bad	"BAD"
Uncertain	"UNCTN"

When power is first applied, the LCD will display the following:

LCD top line	LCD bottom line
"3144"	blank

If the device goes from "Auto" mode to Out-of-Service (OOS) mode, the LCD will display the following:

LCD top line	LCD bottom line
"OOS"	blank



## Section 5 Maintenance

---

Safety Messages .....	page 5-1
Maintenance .....	page 5-2

---

### SAFETY MESSAGES

Instructions and procedures in this section may require special precautions to ensure the safety of the personnel performing the operations. Information that raises potential safety issues is indicated by a warning symbol (⚠). Please refer to the following safety messages before performing an operation preceded by this symbol.

#### WARNING

**Explosions may result in death or serious injury.**

- Do not remove the instrument cover in explosive atmospheres when the circuit is live.
- Before connecting a 375 Field Communicator in an explosive atmosphere, make sure the instruments in the loop are installed in accordance with intrinsically safe or non-incendive field wiring practices.
- Both transmitter covers must be fully engaged to meet explosion-proof requirements.

**Electrical shock could cause death or serious injury. If the sensor is installed in a high-voltage environment and a fault or installation error occurs, high voltage may be present on transmitter leads and terminals.**

- Use extreme caution when making contact with the leads and terminals.

**Failure to follow these installation guidelines could result in death or serious injury:**

- Make sure only qualified personnel perform the installation.

**Process leaks could result in death or serious injury:**

- Install and tighten thermowells or sensors before applying pressure, or process leakage may result.
- Do not remove the thermowell while in operation. Removing while in operation may cause process fluid leaks.

# Rosemount 3144P

---

## MAINTENANCE

The 3144P transmitter has no moving parts and require a minimum amount of scheduled maintenance. The transmitter features a modular design for easy maintenance. If a malfunction is suspected, check for an external cause before performing the diagnostics as discussed in this section.

### Test Terminal (HART / 4–20 mA only)

The test terminal, marked as TEST or (“T”) on the terminal block, and the negative (-) terminal accept MINIGRABBER™, or alligator clips, and facilitate in-process checks (see Figure 2-8 on page 2-11). The test and the negative terminals are connected across a diode through which the loop signal current passes. The current measuring equipment shunts the diode when connected across the test (T) and negative (-) terminals; so as long as the voltage across the terminals is kept below the diode threshold voltage, no current passes through the diode. To ensure that there is no leakage current through the diode while making a test reading, or while an indicating meter is connected, the resistance of the test connection or meter should not exceed 10 ohms. A resistance value of 30 ohms will cause an error of approximately 1.0 percent of reading.

### Sensor Checkout

 If the sensor is installed in a high-voltage environment and a fault condition or installation error occurs, the sensor leads and transmitter terminals could carry lethal voltages. Use extreme caution when making contact with the leads and terminals.

To determine whether the sensor is at fault, either replace it with another sensor or connect a test sensor locally at the transmitter to test remote sensor wiring. Transmitters with Option Code C7 (Trim to Special Sensor), are matched to a specific sensor. Select any standard, off-the-shelf sensor for use with the transmitter, or consult the factory for a replacement special sensor/transmitter combination.

### Electronics Housing

The transmitter is designed with a dual-compartment housing; one compartment contains the electronics module, and the other compartment contains all wiring terminals and the communication receptacles.

#### Removing the Electronics Module

The 3144P electronics module is located in the compartment opposite the wiring terminals.

Use the following procedure to remove the electronics module.

---

#### NOTE

The electronics are sealed in a moisture-resistant plastic enclosure referred to as the electronics module. The module is a non-repairable unit; The entire unit must be replaced if a malfunction occurs.

---

1. Disconnect the power to the transmitter.
-  2. Remove the cover from the electronics side of the transmitter housing (see “ Transmitter Exploded View” on page A-7). Do not remove the covers in explosive atmospheres when the circuit is live. Remove the LCD display, if applicable.

3. Loosen the two screws that anchor the electronics module assembly to the transmitter housing.
4. Firmly grasp the screws and assembly and pull it straight out of the housing, taking care not to damage the interconnecting pins.

---

**NOTE**

If you are replacing the electronics module with a new one, make sure the alarm switches are set in the same position.

---

**Replacing the Electronics Module**

Use the following procedure to reassemble the electronics housing for the 3144P transmitter:

1. Examine the electronics module to ensure that the failure mode and transmitter security switches are in the desired positions.
2. Carefully insert the electronics module to mate the interconnecting pins with the necessary receptacles on the electronics board.
3. Tighten the two mounting screws. Replace the LCD display, if applicable.
-  4. Replace the cover. Tighten  $\frac{1}{6}$  of a revolution after the cover begins to compress the O-ring. Both transmitter covers must be fully engaged to meet explosion proof requirements.



# Section 6 Certified Safety Instrumented System (SIS) 4–20 mA only

---

Safety Messages .....	page 6-1
Certification .....	page 6-1
3144P SIS Identification .....	page 6-1
Installation .....	page 6-2
Commissioning .....	page 6-2
Operation and Maintenance .....	page 6-6
Specifications .....	page 6-7
Spare Parts .....	page 6-7

---

## SAFETY MESSAGES

Procedures and instructions in this section may require special precautions to ensure the safety of the personnel performing the operations. Information that raises potential safety issues is indicated by a warning symbol (⚠). Refer to the following safety messages before performing an operation preceded by this symbol.

<b>⚠ WARNING</b>
Explosions can result in death or serious injury. Electrical shock can result in death or serious injury.

Certified SIS

## CERTIFICATION

The 3144P is certified by TÜVIT to IEC61508 for single transmitter use in Safety Instrumented Systems up to SIL 2 and redundant transmitter use in Safety Instrumented Systems up to SIL 3.

## 3144P SIS IDENTIFICATION

All safety certified 3144P transmitters require safety certified electronics. These electronics can be identified by the yellow plastic casing surrounding the electronics.

To identify a safety certified meter cover.

1. Verify that the electronics casing is yellow (or behind LCD).

# Rosemount 3144P

## INSTALLATION

No special installation is required in addition to the standard installation practices outlined in this document. Always ensure a proper seal by installing the electronics housing cover(s) so that metal contacts metal.

Environmental limits are available in the 3144P Product Data Sheet (document number 00813-0100-4021). This document can be found at [www.rosemount.com/safety/safetytechinfo.htm](http://www.rosemount.com/safety/safetytechinfo.htm).

The loop should be designed so the terminal voltage does not drop below 12 Vdc when the transmitter output is 24.5 mA.

## COMMISSIONING

The 3144P Safety Certified Transmitter can be commissioned by a person with average knowledge of Rosemount temperature transmitters and the configuration device being used.

To commission the 3144P Safety Certified Transmitter, use the HART “3144P SIS Menu Tree” on page 6-4 and “3144P SIS Fast Key Sequences” on page 6-5.

For more information on the 375 Field Communicator see document 00809-0100-4276. AMS help can be found in the AMS on-line guides within the AMS system.

## CONFIGURATION

All configuration methods outlined in Section 3 are the same for the safety certified 3144P temperature transmitter with any differences noted.

### Damping and Alarm Levels

User-adjustable damping will affect the transmitters ability to respond to changes in the applied process. The *damping value + response time* should not exceed the loop requirements.

### NOTES

1. Transmitter output is not safety-rated during the following: configuration changes, multidrop, and loop test. Alternative means should be used to ensure process safety during transmitter configuration and maintenance activities.
2. DCS or safety logic solver should be configured to match transmitter configuration. Figure 6-1 identifies the Rosemount standard alarm and saturation levels (Alarm and saturation values are user-configurable, see page 3-16.)

Setting the alarm values is a two step process

1. With a HART communicator, select the alarm and saturation levels using the following HART fast keys 1, 3, 4, 2.
2. Position the Alarm switch to the required HI or LO position.

Figure 6-1. Rosemount Standard Alarm Levels

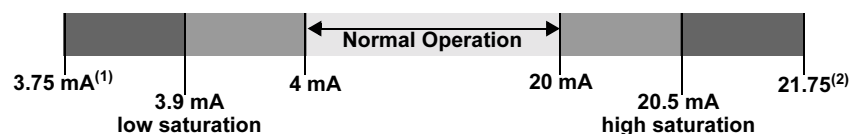

(1) Transmitter Failure, hardware alarm in LO position.

(2) Transmitter Failure, hardware alarm in HI position.

## **Security Switch**

Position the security switch to the “ON” position to prevent accidental or deliberate change of configuration data during normal operation.

## **SIS Additions**

In addition to the dual sensor configurations available in the standard 3144P, the safety certified 3144P HART transmitter supports the configuration and simultaneous use of Hot Backup and Sensor Drift Alert Alarm. If one sensor fails, the transmitter will switch its output to use the remaining good sensor. Should the difference between the two sensor readings exceed the configured threshold, the AO will go to alarm indicating the sensor drift condition. The combination of Sensor Drift Alert Alarm and Hot Backup improves sensor diagnostic coverage while maintaining a high level of availability. Refer to the 3144P SIS FMEDA report for the impact on safety.

## **TRANSMITTER DIAGNOSTICS LOGGING**

The Transmitter Diagnostics Logging feature will store advanced diagnostics information between device resets. This feature stores what caused the transmitter to go into alarm even if that event has disappeared. For example, if the transmitter detects an open sensor due to a loose terminal connection the transmitter will go into alarm. If, due to vibration, that wire begins making a good connection, the transmitter will come out of alarm. This jumping in and out of alarm is very frustrating when determining what is causing the problem. However, the Diagnostics Logging feature will keep track of what caused the transmitter to go into alarm and will save valuable debugging time. This information is available via the field communicator and AMS.

# Rosemount 3144P

## 375 FIELD COMMUNICATOR

The Menu Tree and Fast Key sequences assume that Dev v1, DD v2 (for SIS) is being used.

### 3144P SIS Menu Tree

Figure 6-2 displays a complete 3144P SIS menu tree for use with the 375 Field Communicator. Options listed in bold type indicate that a selection provides other options. For the 3144P transmitter, see "Menu Tree" on page 3-3.

Figure 6-2. 3144P SIS Safety Certified Menu Tree

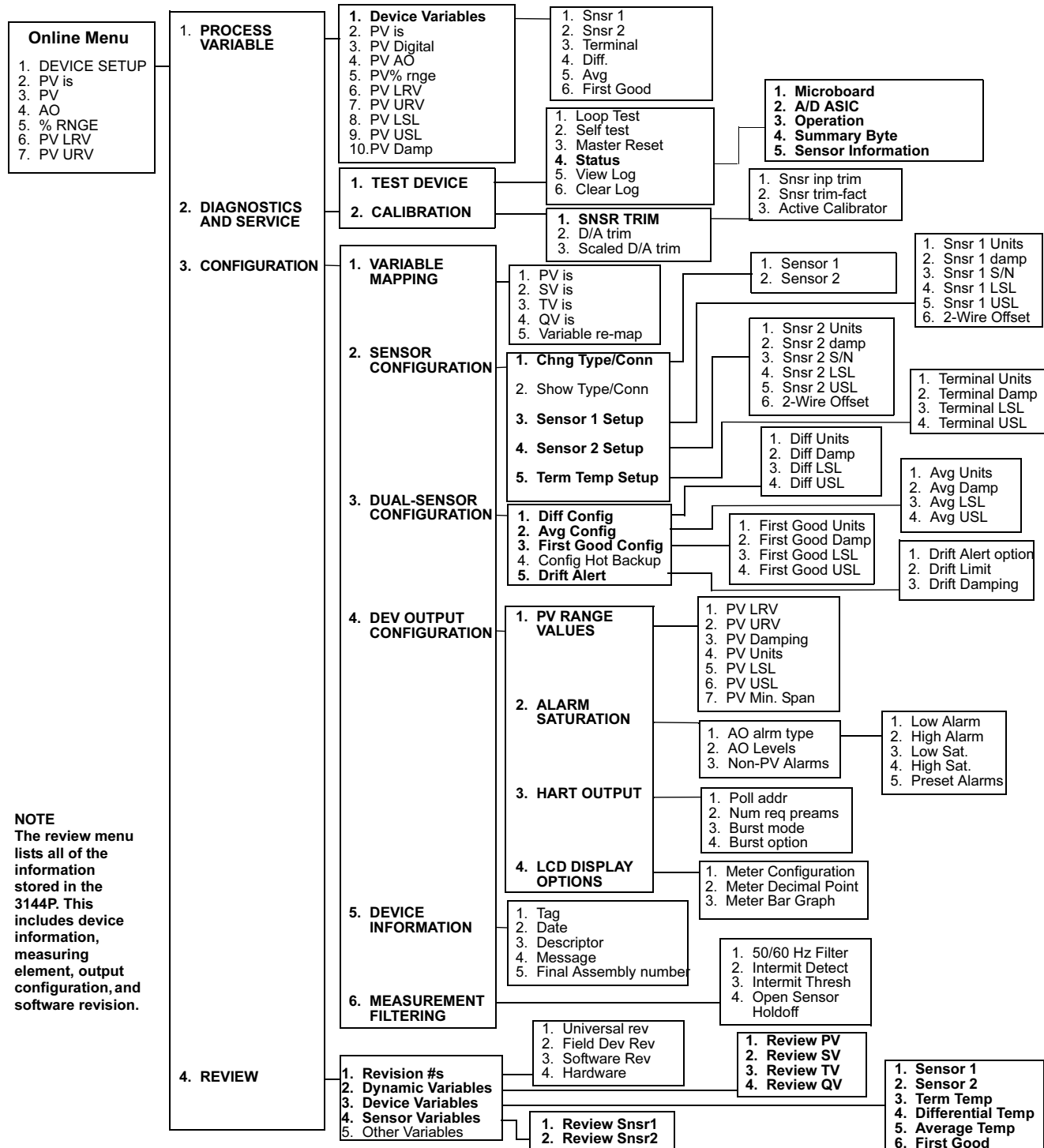



### 3144P SIS Fast Key Sequences

Fast key sequences are listed below for 3144P SIS Safety Certified transmitter functions.

**NOTE:**

Table 6-1 provides alphabetical function lists for all Field Communicator tasks as well as their corresponding fast key sequences.

For the 3144P transmitter, see “Fast Key Sequences” on page 3-4.

Table 6-1. 3144P SIS Fast Key Sequence

Function	HART Fast Keys	Function	HART Fast Keys
Active Calibrator	1, 2, 2, 1, 3	Open Sensor Holdoff	1, 3, 6, 4
Alarm Values	1, 3, 4, 2, 1	Percent Range	1, 1, 5
Analog Output	1, 1, 4	Poll Address	1, 3, 4, 3, 1
Average Temperature Setup	1, 3, 3, 2	Process Temperature	1, 1
Average Temperature Configuration	1, 3, 3, 2	Process Variables	1, 1
Burst Mode	1, 3, 4, 3, 3	Range Values	1, 3, 4, 1
Burst Option	1, 3, 4, 3, 4	Review	1, 4
Calibration	1, 2, 2	Scaled D/A Trim	1, 2, 2, 3
Clear Log	1, 2, 1, 6	Sensor 1 Configuration	1, 3, 2, 3
Configure <i>Hot Backup</i>	1, 3, 3, 4	Sensor 2 Configuration	1, 3, 2, 4
Configuration	1, 3	Sensor Limits	1, 3, 2, 2
D/A Trim	1, 2, 2, 2	Sensor 1 Serial Number	1, 3, 2, 3, 3
Damping Values	1, 3, 4, 1, 3	Sensor 2 Serial Number	1, 3, 2, 4, 3
Date	1, 3, 5, 2	Sensor 1 Setup	1, 3, 2, 3
Descriptor	1, 3, 5, 3	Sensor 2 Setup	1, 3, 2, 4
Device Information	1, 3, 5	Sensor Trim	1, 2, 2, 1, 1
Diagnostics and Service	1, 2	Sensor Type	1, 3, 2, 1
Differential Temperature Setup	1, 3, 3, 1	Sensor 1 Unit	1, 3, 2, 3, 1
Differential Temperature Configuration	1, 3, 3, 1	Sensor 2 Unit	1, 3, 2, 4, 1
Drift Alert	1, 3, 3, 5	Software Revision	1, 4, 1
Filter 50/60 Hz	1, 3, 6, 1	Status	1, 2, 1, 4
First Good Temperature Setup	1, 3, 3, 3	Tag	1, 3, 5, 1
First Good Temperature Configuration	1, 3, 3, 3	Terminal Temperature Setup	1, 3, 2, 5
Hardware Revision	1, 4, 1	Test Device	1, 2, 1
Hart Output	1, 3, 4, 3	Transmitter-Sensor Matching	1, 3, 2, 1
Intermittent Sensor Detect	1, 3, 6, 2	URV (Upper Range Value)	1, 3, 4, 1, 2
Intermittent Threshold	1, 3, 6, 3	USL (Upper Sensor Limit)	1, 3, 4, 1, 6
Loop Test	1, 2, 1, 1	Variable Mapping	1, 3, 1
LRV (Lower Range Value)	1, 3, 4, 1, 1	View Log	1, 2, 1, 5
LSL (Lower Sensor Limit)	1, 3, 4, 1, 5	Wires	1, 3, 2, 1
Master Reset	1, 2, 1, 3	2-wire Offset Sensor 1	1, 3, 2, 3, 6
Message	1, 3, 5, 4	2-wire Offset Sensor 2	1, 3, 2, 4, 6
Meter Options	1, 3, 4, 4		



## OPERATION AND MAINTENANCE

### Proof Test

The following proof tests are recommended. In the event that an error is found in the safety functionality, proof test results and corrective actions taken must be documented at [www.rosemount.com/safety](http://www.rosemount.com/safety).

Use "Table 6-1: 3144P SIS Fast Key Sequence" to perform Loop Test, Review – Device Variables, and view Status. See the 3144P Reference Manual (00809-0100-4021) for additional information.

The required proof test intervals will depend on the transmitter configuration and the temperature sensor(s) in use. Guidance is available in Table 6-2. Refer to the FMEDA report for further information.

#### Abbreviated Proof Test

Conducting the Abbreviated Proof Test will detect approximately 63% of transmitter DU failures and approximately 90% of temperature sensor(s) DU failures, not detected by the 3144P SIS automatic diagnostics.

1. Using Loop Test enter the milliampere value representing a high alarm state.
2. Check the reference meter to verify the mA output corresponds to the entered value.
3. Using Loop Test enter the milliampere value representing a low alarm state.
4. Check the reference meter to verify the mA output corresponds to the entered value.
5. Use a HART communicator to view detailed device status to ensure no alarms or warnings are present in the transmitter.
6. Check that sensor value(s) are reasonable in comparison to a basic process control system (BPCS) value.
7. Document the test results per the plant's requirements.

#### Extended Proof Test

Conducting the Extended Proof Test, which includes the Abbreviated Proof Test, will detect approximately 96% of transmitter DU failures and approximately 99% of temperature sensor(s) DU failures, not detected by the 3144P SIS automatic diagnostics.

1. Execute the Abbreviated Proof Test.
2. Perform a minimum two point sensor verification check. If two sensors are used, repeat for each sensor. If calibration is required for the installation, it may be done in conjunction with this verification.
3. Verify that the housing temperature value is reasonable.
4. Document the test results per the plant's requirements.

Table 6-2. Proof test interval guideline

Sensors	SFF	Abbreviated Proof Test	Extended Proof Test	Notes
4-wire RTD	97.7%	10 years	10 years	
T/C	94.7%	1 year 2 years	10 years 2 years	
Dual T/C	99.6%	10 years	10 years	Using U3 Drift Alert Alarm & HotBackup
Dual 3-wire RTD	98.9%	10 years	10 years	Using U3 Drift Alert Alarm & HotBackup
T/C & 3-wire RTD	99.3%	10 years	10 years	Using U3 Drift Alert Alarm & HotBackup

Proof test intervals are based on sensor failure rates from the *Safety Equipment Reliability Handbook*, exida.com, 2003. A low stress environment is assumed, with 30% of SIL 2 PFDavg limit budgeted for the transmitter and sensor element. See the FMEDA report for additional details or references.

**Inspection**

The 3144P is repairable by major component replacement.

**Visual Inspection**

Not required

**Special Tools**

Not required

**Product Repair**

All failures detected by the transmitter diagnostics or by the proof-test must be reported. Feedback can be submitted electronically at [www.rosemount.com/safety/safetytechinfo.htm](http://www.rosemount.com/safety/safetytechinfo.htm) (mail button).

**SPECIFICATIONS**

The 3144P SIS must be operated in accordance to the functional and performance specifications provided in the 3144P Product Data Sheet (document number 00813-0100-4021) or in Appendix A: Reference Data.

**Failure Rate Data**

The FMEDA report includes failure rates, common cause Beta factor estimates, and independent information on generic sensor models.

The report is available at [www.rosemount.com/safety/safetytechinfo.htm](http://www.rosemount.com/safety/safetytechinfo.htm).

**Product Life**

50 years – based on worst case component wear-out mechanisms – not based on wear-out of process sensors.

Report any safety related product information at <http://www.rosemount.com/safety/safetytechinfo.htm>.

**SPARE PARTS**

These spare parts are available for the safety certified transmitter only.

Description	Part Number
Safety Certified electronics module assembly (single sensor configuration)	03144-1601-0001
Safety Certified electronics module assembly (dual sensor configuration)	03144-1601--0002



# Rosemount 3144P

---

**Reference Manual**  
00809-0100-4021, Rev DA  
November 2004

Certified SIS

# Section 7      Prior Use (PU) Safety Instrumented System

## 4–20 mA only

---

Overview .....	page 7-1
Safe Failure Fraction .....	page 7-2
Installation .....	page 7-2

---

### OVERVIEW

This section details the requirements for using the 3144P in Prior Use (PU) Safety Instrumented Systems (SIS). Although the 3144P is certified for functional safety per IEC61508, the non-certified transmitter may also be used in Safety Applications using the PU. The complete Failure Modes, Effects, and Diagnosis Analysis (FMEDA) was completed to determine the safe failure fraction (SFF) when using this device in a SIS application.

FMEDA are the device characteristics that are taken into account when attempting to achieve functional safety certification per IEC61508 of a device. From the FMEDA, failure rates are determined for all temperature sensing device options. Furthermore, the Safe Failure Fraction is calculated for each of the four different input device configurations.

The non-certified 3144P is an isolated 2-wire 4-20 mA SMART device classified as Type B according to IEC61508. It contains self-diagnostics and is programmed to send its output to either a high or low failure state upon internal detection of a failure.

The analysis shows that the device has a safe failure fraction between 60 and 90% (assuming that the logic solver is programmed to detect over-scale and under-scale currents). The device has a safe failure fraction of over 90% when used with a temperature sensing device, such as thermocouple or RTD. The device can detect open and short circuit failures of these temperature sensing devices.

Refer to the 3144P SIS FMEDA report for failure rate data.

Prior Use SIS

# Rosemount 3144P

## SAFE FAILURE FRACTION

The Safe Failure Fraction calculation for the combination of the 3144P and the process sensor must consider the effects of the transmitter's process sensor diagnostics. The following is an example only. The 3144P FMEDA report should be consulted for actual transmitter failure rates. Sensor failure data may be found in various references, or may be based on the user's experience history. All failure rates are listed in FITs.

### Example

#### Transmitter Only:

Lambda H = 33  
 Lambda L = 334  
 Lambda DU = 74  
 Lambda Total = 459

#### Sensor Only:

Lambda Total = 200  
 %L = 99% (open circuit 70% + short circuit 29%)  
 %DU = 1% (drift 1%)  
 Lambda L = 1980 (99% of 2000)  
 Lambda DU = 20 (1% of 2000)

#### Transmitter plus Sensor:

Lambda DU = 94 (Lambda DU Transmitter + Lambda DU Sensor)  
 Lambda Total = 2459 (Lambda Transmitter + Lambda Sensor)  
 Safe Failure Fraction = 96.2% (Lambda DU / Lambda Total)

## INSTALLATION

No special installation practices are necessary with the 3144P in a PU Safety Instrumented System. However, a full review of the Failure Mode and Security switches is required. Follow the standard installation requirements (see Section 2: Installation).

### Switches

#### Failure Mode Switch

The transmitter monitors itself during normal operation using an automatic diagnostic routine. If the diagnostic routine detects a sensor failure or a failure in the transmitter electronics, the transmitter goes into high or low alarm, depending on the position of the failure mode switch.

The analog alarm and saturation values that the transmitter uses depend on whether it is configured to standard (set by the factory) or NAMUR-compliant operation. These values are also custom-configurable in both the factory and the field using the 375 Field Communicator. The limits are:

- $21.0 \leq I \leq 23$  for high alarm
- $3.5 \leq I \leq 3.75$  for low alarm

The values for standard and NAMUR operation are as follows:

Characteristics	Standard Operation	NAMUR-Compliant Operation
Fail High	$21.75 \text{ mA} \leq I \leq 23.0 \text{ mA}$	$21.0 \text{ mA} \leq I \leq 23.0 \text{ mA}$
High Saturation	$I \geq 20.5 \text{ mA}$	$I \geq 20.5 \text{ mA}$
Low Saturation	$I \leq 3.90 \text{ mA}$	$I \leq 3.8 \text{ mA}$
Fail Low	$I \leq 3.75 \text{ mA}$	$I \leq 3.6 \text{ mA}$

#### Transmitter Security Switch

The transmitter is equipped with a write-protect switch that can be positioned to prevent both accidental and deliberate change of configuration data.

### Changing Switch Position

The Failure Mode and Security switches are located on the top center of the electronics module (see Figure 7-1). The electronics module is on the electronics side of the transmitter housing. For transmitters with LCD displays, the electronics module is located behind the LCD display faceplate.

#### Without a LCD display

1. If the transmitter is installed, set the loop to manual.
- ⚠ 2. Remove the housing cover on the electronics side of the transmitter. Do not remove the transmitter cover in explosive atmospheres when the circuit is live.
3. Set the switches to the desired position (see Figure 7-1).
- ⚠ 4. Replace the transmitter cover. Both transmitter covers must be fully engaged to meet explosion-proof requirements.
5. Set the loop to automatic control.

#### With a LCD display

1. If the transmitter is installed, set the loop to manual.
- ⚠ 2. Remove the housing cover on the electronics side of the transmitter. Do not remove the transmitter cover in explosive atmospheres when the circuit is live.
3. Remove the housing cover, unscrew the LCD display screws and gently slide the meter straight off.
4. Set the switches to the desired position (see Figure 7-1).
5. Gently slide the LCD display back into place, taking extra precautions of the 10 pin connection.
6. Secure the LCD display by replacing the LCD display screws.
- ⚠ 7. Replace the transmitter cover. Both transmitter covers must be fully engaged to meet explosion-proof requirements.
8. Set the loop to automatic control.

Figure 7-1. Transmitter Jumper Locations.

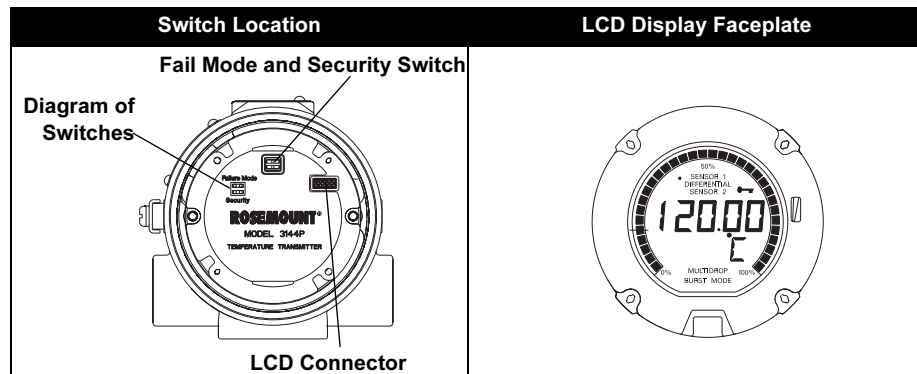

3144-0200G33A, 0001E01B

Prior Use SIS

# Rosemount 3144P

---

**Reference Manual**  
00809-0100-4021, Rev DA  
November 2004

Prior Use SIS



---

## Appendix A      Reference Data

---

---

HART and Foundation Fieldbus Specifications . . . . .	page A-1
HART / 4–20 mA Specifications . . . . .	page A-6
Foundation Fieldbus Specifications . . . . .	page A-8
Dimensional Drawings . . . . .	page A-10
Ordering Information . . . . .	page A-14

---

### HART AND FOUNDATION FIELDBUS SPECIFICATIONS

#### Functional Specifications

##### Inputs

User-selectable. See “Accuracy” on page A-4 for sensor options.

##### Output

2-wire device with either 4–20 mA/HART, linear with temperature or input. Completely digital output with FOUNDATION fieldbus communication (ITK 4.5 compliant).

##### Isolation

Input/output isolation tested up to 500 V rms (707 V dc).

##### Humidity Limits

0–100% relative humidity.

##### Update Time

Approximately 0.5 seconds for a single sensor (1 second for dual sensors).

#### Physical Specifications

##### Conduit Connections

The standard field mount housing has ½–14 NPT conduit entries. Additional conduit entry type are available, including PG13.5 (PG11), M20 X 1.5 (CM20), or JIS G ½. When any of these additional entry types are ordered, adapters are placed in the standard field housing so these alternative conduit types fit correctly. See “Dimensional Drawings” on page A-10 for dimensions.

##### Materials of Construction

Electronics Housing

- Low-copper aluminum or CF-8M (cast version of 316 Stainless Steel)

Paint

- Polyurethane

##### Cover O-rings

Buna-N

## Performance Specifications

### Mounting

Transmitters may be attached directly to the sensor. Optional mounting brackets (codes B4 and B5) permit remote mounting. See “Optional Transmitter Mounting Brackets” on page A-12.

### Weight

Aluminum <sup>(1)</sup>	Stainless Steel <sup>(1)</sup>
3.1 lb (1.4 kg)	7.8 lb (3.5 kg)
<i>(1) Add 0.5 lb (0.2 kg) for meter or 1.0 lb (0.5 kg) for bracket options.</i>	

### Enclosure Ratings

NEMA 4X, CSA Enclosure Type 4X, IP66, and IP68.

The 3144P maintains a specification conformance of at least 3  $\sigma$ .

### Stability

- $\pm 0.1\%$  of reading or 0.1 °C, whichever is greater, for 24 months for RTDs.
- $\pm 0.1\%$  of reading or 0.1 °C, whichever is greater, for 12 months for thermocouples.

### 5 Year Stability

- $\pm 0.25\%$  of reading or 0.25 °C, whichever is greater, for 5 years for RTDs.
- $\pm 0.5\%$  of reading or 0.5 °C, whichever is greater, for 5 years for thermocouples.

### Vibration Effect

Tested to the following with no effect on performance:

Frequency	Acceleration
10–60 Hz	0.21 mm peak displacement
60–2000 Hz	3 g

### Self Calibration

The analog-to-digital measurement circuitry automatically self-calibrates for each temperature update by comparing the dynamic measurement to extremely stable and accurate internal reference elements.

### RFI Effect

Worst case RFI effect is equivalent to the transmitter’s nominal accuracy specification, according to Table on page A-4, when tested in accordance with ENV 50140, 30 V/m (HART) / 10 V/m (FOUNDATION fieldbus), 80 to 1000 MHz, with unshielded cable.

### CE Electromagnetic Compatibility Compliance Testing

The 3144P meets all requirements listed under IEC 61326: Amendment 1, 1998.

**External Ground Screw Assembly**

The external ground screw assembly can be ordered by specifying code G1 when an enclosure is specified. However, some approvals include the ground screw assembly in the transmitter shipment, hence it is not necessary to order code G1. The table below identifies which approval options include the external ground screw assembly.

Approval Type	External Ground Screw Assembly Included <sup>(1)</sup>
NA, E5, K5, K6, KB	No—Order option code G1
N1, E1, I1, ND, K1, E7, N7, I7, K7, KA, I2, E4	Yes

*(1) Code G1 is also included with Integral Protector option code T1 and does not need to be ordered separately.*

**Hardware Tag**

- No charge
- 2 lines of 28 characters (56 characters total)
- Tags are stainless steel
- Permanently attached to transmitter
- Character height is 1/16-in. (1.6mm)
- A wire-on tag is available upon request. 5 lines of 12 characters (60 characters total)

**Software Tag**

- HART transmitter can store up to 8 characters. FOUNDATION fieldbus transmitters can store up to 32 characters.
- Can be ordered with different software and hardware tags.
- If no software tag characters are specified, the first 8 characters of the hardware tag are the default.

## Accuracy

Sensor Options	Sensor Reference	Input Ranges		Recommended Min. Span <sup>(1)</sup>		Digital Accuracy <sup>(2)</sup>		D/A Accuracy <sup>(3)(4)</sup>
		°C	°F	°C	°F	°C	°F	
<b>2-, 3-, 4-wire RTDs</b>								
Pt 100	IEC 751, 1995 ( $\alpha = 0.00385$ )	-200 to 850	-328 to 1562	10	18	± 0.10	± 0.18	±0.02% of span
Pt 100	JIS 1604, 1981 ( $\alpha = 0.003916$ )	-200 to 645	-328 to 1193	10	18	± 0.10	± 0.18	±0.02% of span
Pt 200	IEC 751, 1995 ( $\alpha = 0.00385$ )	-200 to 850	-328 to 1562	10	18	± 0.22	± 0.40	±0.02% of span
Pt 500	IEC 751, 1995 ( $\alpha = 0.00385$ )	-200 to 850	-328 to 1562	10	18	± 0.14	± 0.25	±0.02% of span
Pt 1000	IEC 751, 1995 ( $\alpha = 0.00385$ )	-200 to 300	-328 to 572	10	18	± 0.10	± 0.18	±0.02% of span
Ni 120	Edison Curve No. 7	-70 to 300	-94 to 572	10	18	± 0.08	± 0.14	±0.02% of span
Cu 10	Edison Copper Winding No. 15	-50 to 250	-58 to 482	10	18	±1.00	± 1.80	±0.02% of span
<b>Thermocouples<sup>(5)</sup></b>								
Type B <sup>(6)</sup>	NIST Monograph 175, IEC 584	100 to 1820	212 to 3308	25	45	± 0.75	± 1.35	±0.02% of span
Type E	NIST Monograph 175, IEC 584	-50 to 1000	-58 to 1832	25	45	± 0.20	± 0.36	±0.02% of span
Type J	NIST Monograph 175, IEC 584	-180 to 760	-292 to 1400	25	45	± 0.25	± 0.45	±0.02% of span
Type K <sup>(7)</sup>	NIST Monograph 175, IEC 584	-180 to 1372	-292 to 2502	25	45	± 0.25	± 0.45	±0.02% of span
Type N	NIST Monograph 175, IEC 584	-200 to 1300	-328 to 2372	25	45	± 0.40	± 0.72	±0.02% of span
Type R	NIST Monograph 175, IEC 584	0 to 1768	32 to 3214	25	45	± 0.60	± 1.08	±0.02% of span
Type S	NIST Monograph 175, IEC 584	0 to 1768	32 to 3214	25	45	± 0.50	± 0.90	±0.02% of span
Type T	NIST Monograph 175, IEC 584	-200 to 400	-328 to 752	25	45	± 0.25	± 0.45	±0.02% of span
DIN Type L	DIN 43710	-200 to 900	-328 to 1652	25	45	± 0.35	± 0.63	±0.02% of span
DIN Type U	DIN 43710	-200 to 600	-328 to 1112	25	45	± 0.35	± 0.63	±0.02% of span
Type W5Re/ W26Re	ASTM E 988-96	0 to 2000	32 to 3632	25	45	± 0.70	± 1.26	±0.02% of span
Millivolt Input		-10 to 100 mV		3 mV		±0.015 mV		±0.02% of span
2-, 3-, 4-wire Ohm Input		0 to 2000 ohms		20 ohm		±0.35 ohm		±0.02% of span

- (1) No minimum or maximum span restrictions within the input ranges. Recommended minimum span will hold noise within accuracy specification with damping at zero seconds.
- (2) Digital accuracy: Digital output can be accessed by the 375 Field Communicator.
- (3) Total Analog accuracy is the sum of digital and D/A accuracies.
- (4) Applies to HART / 4-20 mA devices.
- (5) Total digital accuracy for thermocouple measurement: sum of digital accuracy +0.25 °C (0.45 °F) (cold junction accuracy).
- (6) Digital accuracy for NIST Type B is ±3.0 °C (±5.4 °F) from 100 to 300 °C (212 to 572 °F).
- (7) Digital accuracy for NIST Type K is ±0.50 °C (±0.9 °F) from -180 to -90 °C (-292 to -130 °F).

### Reference Accuracy Example (HART only)

When using a Pt 100 ( $\alpha = 0.00385$ ) sensor input with a 0 to 100 °C span: Digital Accuracy would be ±0.10 °C, D/A accuracy would be ±0.02% of 100 °C or ±0.02 °C, Total = ±0.12 °C.

### Differential Capability Exists Between Any Two Sensor Types (dual-sensor option)

For all differential configurations, the input range is X to Y where:

- X = Sensor 1 minimum – Sensor 2 maximum *and*
- Y = Sensor 1 maximum – Sensor 2 minimum.

### Digital Accuracy for Differential Configurations (dual-sensor option, HART only)

- Sensor types are similar (e.g., both RTDs or both T/Cs): Digital Accuracy = 1.5 times worst case accuracy of either sensor type.
- Sensor types are dissimilar (e.g., one RTD, one T/C): Digital Accuracy = Sensor 1 Accuracy + Sensor 2 Accuracy.

**Ambient Temperature Effect**

Table A-1. Ambient Temperature Effect

Sensor Options	Digital Accuracy per 1.0 °C (1.8 °F) Change in Ambient <sup>(1)</sup>	Range	D/A Effect <sup>(2)</sup>
2-, 3-, or 4- Wire RTDs			
Pt 100 ( $\alpha = 0.00385$ )	0.0015 °C	Entire Sensor Input Range	0.001% of span
Pt 100 ( $\alpha = 0.003916$ )	0.0015 °C	Entire Sensor Input Range	0.001% of span
Pt 200	0.0023 °C	Entire Sensor Input Range	0.001% of span
Pt 500	0.0015 °C	Entire Sensor Input Range	0.001% of span
Pt 1000	0.0015 °C	Entire Sensor Input Range	0.001% of span
Ni 120	0.0010 °C	Entire Sensor Input Range	0.001% of span
Cu 10	0.015 °C	Entire Sensor Input Range	0.001% of span
Thermocouples			
Type B	0.014 °C 0.029 °C – 0.0021% of (R – 300) 0.046 °C – 0.0086% of (R – 100)	$R \geq 1000$ °C $300$ °C $\leq R < 1000$ °C $100$ °C $\leq R < 300$ °C	0.001% of span
Type E	0.004 °C + 0.00043% of R		0.001% of span
Type J	0.004 °C + 0.00029% of R 0.004 °C + 0.0020% of abs. val. R	$R \geq 0$ °C $R < 0$ °C	0.001% of span
Type K	0.005 °C + 0.00054% of R 0.005 °C + 0.0020% of abs. val. R	$R \geq 0$ °C $R < 0$ °C	0.001% of span
Type N	0.005 °C + 0.00036% of R	All	0.001% of span
Types R and S	0.015 °C 0.021 °C – 0.0032% of R	$R \geq 200$ °C $R < 200$ °C	0.001% of span
Type T	0.005 °C 0.005 °C + 0.00036% of abs. val. R	$R \geq 0$ °C $R < 0$ °C	0.001% of span
DIN Type L	0.0054 °C + 0.00029% of R 0.0054 °C + 0.0025% of abs. val. R	$R \geq 0$ °C $R < 0$ °C	0.001% of span
DIN Type U	0.0064 °C 0.0064 °C + 0.0043% of abs. val. R	$R \geq 0$ °C $R < 0$ °C	0.001% of span
Type W5Re/W26Re	0.016 °C 0.023 °C + 0.0036% of R	$R \geq 200$ °C $R < 200$ °C	0.001% of span
Millivolt Input	0.00025 mV	Entire Sensor Input Range	0.001% of span
2-, 3-, 4-wire Ohm Input	0.007 $\Omega$	Entire Sensor Input Range	0.001% of span

(1) Change in ambient is in reference to the calibration temperature of the transmitter (20° C [68° F])  
(2) Applies to HART / 4-20 mA devices.

Transmitters may be installed in locations where the ambient temperature is between –40 and 85 °C (–40 and 185 °F). To maintain excellent accuracy performance, each transmitter is individually characterized over this ambient temperature range at the factory.

**Temperature Effects Example**

When using a Pt 100 ( $\alpha = 0.00385$ ) sensor input with a 0 to 100 °C span at 30 °C ambient temperature, the following statements would be true:

**Digital Temp Effects**

- $0.0015^{\circ}\text{C} \times (30 - 20) = 0.015^{\circ}\text{C}$

**D/A Effects (HART / 4–20 mA only)**

- $[0.0\% \text{ of } 100] \times (30 - 20) = 0.01^{\circ}\text{C}$

**Worst Case Error**

- Digital + D/A + Digital Temp Effects + D/A Effects =  $0.10^{\circ}\text{C} + 0.02^{\circ}\text{C} + 0.015^{\circ}\text{C} + 0.01^{\circ}\text{C} = 0.145^{\circ}\text{C}$

**Total Probable Error**

$$\sqrt{0.10^2 + 0.02^2 + 0.015^2 + 0.01^2} = 0.10^{\circ}\text{C}$$

## HART / 4–20 MA SPECIFICATIONS

### Power Supply

External power supply required. Transmitters operate on 12.0 to 42.4 V dc transmitter terminal voltage (with 250 ohm load, 18.1 V dc power supply voltage is required). Transmitter power terminals rated to 42.4 V dc.

### Wiring Diagram

See Figure 1 on page A-13.

### Alarms

Custom factory configurations of alarm and saturation levels are available for valid values with option code C1. These values can also be configured in the field using a 375 Field Communicator.

### Transient Protection (option code T1)

The transient protector helps to prevent damage to the transmitter from transients induced on the loop wiring by lightning, welding, heavy electrical equipment, or switch gears. The transient protection electronics are contained in an add-on assembly that attaches to the standard transmitter terminal block. The external ground lug assembly (code G1) is included with the Transient Protector. The transient protector has been tested per the following standard:

- IEEE C62.41-1991 (IEEE 587)/ Location Categories B3.  
6kV/3kA peak ( $1.2 \times 50 \mu\text{S}$  Wave  $8 \times 20 \mu\text{S}$  Combination Wave)  
6kV/0.5kA peak (100 kHz Ring Wave)  
EFT, 4kVpeak, 2.5kHz,  $5 \times 50\text{nS}$
- Loop resistance added by protector: 22 ohms max.
- Nominal clamping voltages: 90 V (common mode), 77 V (normal mode)

### Local Display

Optional five-digit LCD display includes 0–100% bar graph. Digits are 0.4 inches (8 mm) high. Display options include engineering units (°F, °C, °R, K, ohms, and millivolts), percent, and milliamperes. The display can also be set to alternate between engineering units/milliamperes, Sensor 1/Sensor 2, Sensor 1/Sensor 2/Differential Temperature, and Sensor 1/Sensor 2/Average Temperature. All display options, including the decimal point, may be reconfigured in the field using a 375 Field Communicator or AMS.

### Turn-on Time

Performance within specifications is achieved less than 5 seconds (6 seconds for Safety Certified transmitter) after power is applied to the transmitter when the damping value is set to 0 seconds.

### Power Supply Effect

Less than  $\pm 0.005\%$  of span per volt.

### SIS Safety Transmitter Failure Values

TÜV IEC 61508 Safety Certified SIL 2 Claim Limit

- Safety accuracy:  $2.0\%$ <sup>(1)</sup> or  $2^\circ\text{C}$  ( $3.6^\circ\text{F}$ ), whichever is greater
- Safety response time: 5 seconds

(1) A 2% variation of the transmitter mA output is allowed before a safety trip. Trip values in the DCS or safety logic solver should be derated by 2%.

**Temperature Limits**

Description	Operating Limit	Storage Limit
Without LCD Display	-40 to 185 °F	-60 to 250 °F
	-40 to 85 °C	-50 to 120 °C
With LCD Meter	-4 to 185 °F	-50 to 185 °F
	-20 to 85 °C	-45 to 85 °C

**HART Communicator Connections**

375 Field Communicator connections are permanently fixed to power/signal block.

**Failure Mode**

The 3144P features software and hardware failure mode detection. An independent circuit is designed to provide backup alarm output if the microprocessor hardware or software fails.

The alarm level is user-selectable using the failure mode switch. If failure occurs, the position of the hardware switch determines the direction in which the output is driven (HIGH or LOW). The switch feeds into the digital-to-analog (D/A) converter, which drives the proper alarm output even if the microprocessor fails. The values at which the transmitter drives its output in failure mode depends on whether it is configured to standard, or NAMUR-compliant (NAMUR recommendation NE 21, 1999) operation. The values for standard and NAMUR-compliant operation are as follows:

Table A-2. Operation Parameters

	Standard <sup>(1)</sup>	NAMUR-Compliant <sup>(1)</sup>
Linear Output:	$3.9 \leq I \leq 20.5$	$3.8 \leq I \leq 20.5$
Fail HIGH:	$21.75 \leq I \leq 23$ (default)	$21.5 \leq I \leq 23$ (default)
Fail Low:	$I \leq 3.75$	$I \leq 3.6$

<sup>(1)</sup> Measured in milliamperes

**Load Limitations**

Maximum Load =  $40.8 \times (\text{Supply Voltage} - 12.0)$ <sup>(1)</sup>

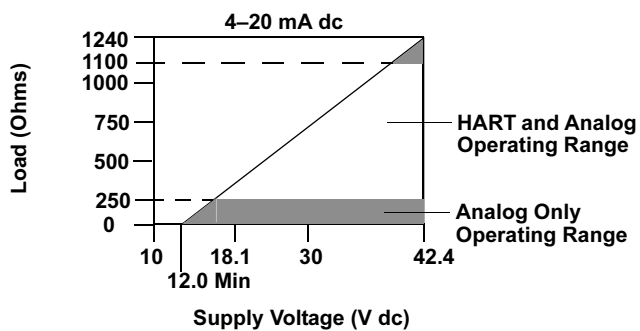

<sup>(1)</sup> Without transient protection (optional).

**NOTE**

HART Communication requires a loop resistance between 250 and 1100 ohms. Do not communicate with the transmitter when power is below 12 V dc at the transmitter terminals.

## **FOUNDATION FIELDBUS SPECIFICATIONS**

### **Power Supply**

Powered over FOUNDATION Fieldbus with standard fieldbus power supplies. Transmitters operate on 9.0 to 32.0 V dc, 11 mA maximum. Transmitter power terminals are rated to 42.4 V dc.

### **Wiring Diagram**

See Figure 2 on page A-13.

### **Alarms**

The AI function block allows the user to configure the alarms to HIGH-HIGH, HIGH, LOW, or LOW-LOW with a variety of priority levels and hysteresis settings

### **Transient Protection (option code T1)**

The transient protector helps to prevent damage to the transmitter from transients induced on the loop wiring by lightning, welding, heavy electrical equipment, or switch gears. The transient protection electronics are contained in an add-on assembly that attaches to the standard transmitter terminal block. The transient terminal block is not polarity insensitive. The transient protector has been tested to the following standard:

- IEEE C62.41-1991 (IEEE 587), Location Categories B3.
- Combinational Wave, 6kV/3kA peak, 1.2\*50uS/8\*20uS.
- Ring Wave, 100kHz, 6kV/0.5kA peak
- EFT, 4kV, 2.5kHz, 5\*50nS
- Loop resistance added by protector: 22 ohms max.
- Nominal clamping voltages:90 V (common mode),  
77 V (normal mode)

### **Local Display**

Displays all DS\_65 measurements in the Transducer and Function Blocks including Sensor 1, Sensor 2, differential and terminal temperatures. The display alternates up to four selected items. The meter can display up to five digits in engineering units (°F, °C, °R, K, Ω, and millivolts). Display settings are configured at the factory according to the transmitter configuration (standard or custom). These settings can be reconfigured in the field using a 375 Field Communicator or DeltaV. In addition, the LCD provides the ability to display DS\_65 parameters from other devices. In addition to the configuration of the meter, sensor diagnostic data is displayed. If the measurement status is Good, the measured value is shown. If the measurement status is Uncertain, the status indicating uncertain is show in addition to the measured value. If the measurement status is Bad, the reason for the bad measurement is shown.

Note: When ordering a spare electronics module assembly, the LCD transducer block will display the default parameter.

### **Turn-on Time**

Performance within specifications is achieved less than 20 seconds after power is applied to the transmitter when the damping value is set to 0 seconds.



### Status

If self-diagnostics detect a sensor burnout or a transmitter failure, the status of the measurement will be updated accordingly. The status may also send the PID output to a safe value.

### FOUNDATION Fieldbus Parameters

Schedule Entries	25 (max.)
Links	30 (max.)
Virtual Communications Relationships (VCR)	20 (max.)

### Software Upgrade in the Field

Software for the 3144P with FOUNDATION fieldbus is easy to upgrade in the field. Take advantage of software enhancements by loading new application software into the device memory.

### Backup Link Active Scheduler (LAS)

The transmitter is classified as a device link master, which means it can function as a Link Active Scheduler (LAS) if the current link master device fails or is removed from the segment. The host or other configuration tool is used to download the schedule for the application to the link master device. In the absence of a primary link master, the transmitter will claim the LAS and provide permanent control for the H1 segment.

### Function Blocks

#### Resource Block

- Contains physical transmitter information including available memory, manufacture identification, device type, software tag, and unique identification.
- PlantWeb Alerts enable the full power of the PW digital architecture by diagnosing instrumentation issues, communicating the details, and recommending a solution.

#### Transducer Block

- Contains the actual temperature measurement data, including sensor 1, sensor 2, and terminal temperature.
- Includes information about sensor type and configuration, engineering units, linearization, range, damping, and diagnostics.

#### LCD Block (when an LCD display is used)

- Configures the local display.

#### Analog Input (AI)

- Processes the measurement and makes it available on the fieldbus segment.
- Allows filtering, engineering unit, and alarm changes.

#### PID Block (provides control functionality)

- Performs single loop, cascade, or feedforward control in the field.

### Instantiable Function Blocks

- All the function blocks used by the transmitter are instantiable, meaning the total number of function blocks is only limited by the physical memory available in the transmitter. Since only the instantiated blocks can use physical memory, any combination of function blocks can be used at any given time as long as the physical memory size is not violated.

Block	Execution Time
Resource	–
Transducer	–
LCD Block	–
Advanced Diagnostics	–
Analog Input 1, 2, 3	60 milliseconds
PID 1 and 2 with Autotune	90 milliseconds
Input Selector	65 milliseconds
Signal Characterizer	45 milliseconds
Arithmetic	60 milliseconds
Output Splitter	60 milliseconds

### DIMENSIONAL DRAWINGS

Transmitter Exploded View	Switch Location
	<p>(1) Alarm and Write Protect (HART), Simulate and Write Protect (FOUNDATION Fieldbus)</p>
	<h3>LCD Display Faceplate</h3>

3144-0001B01B

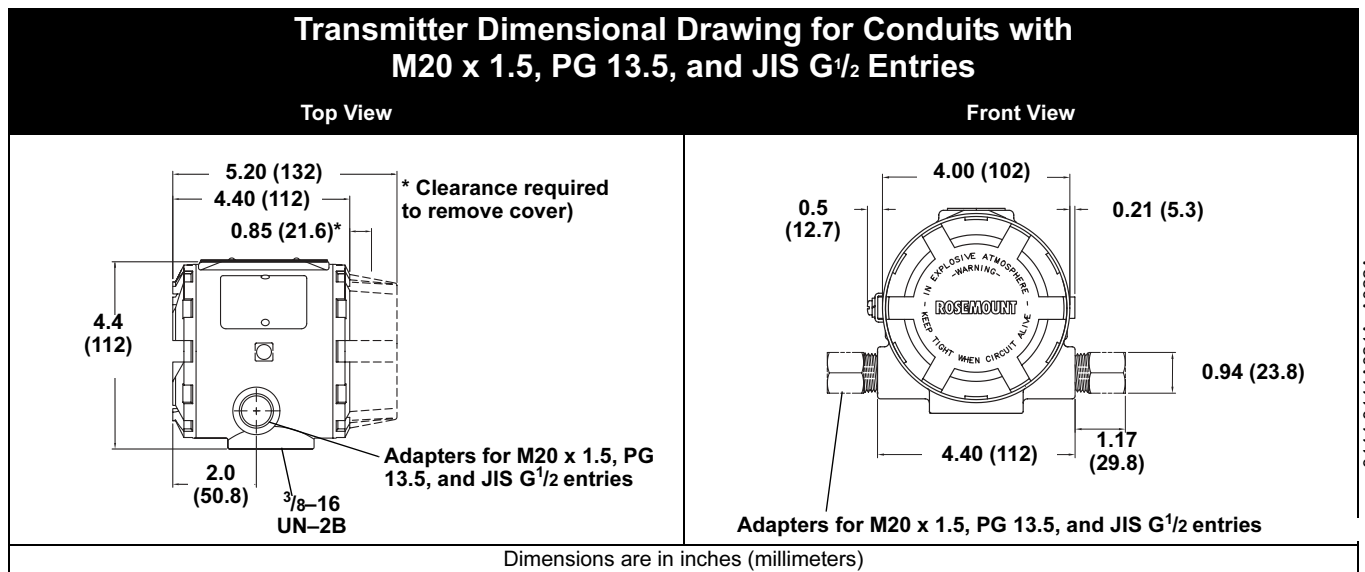
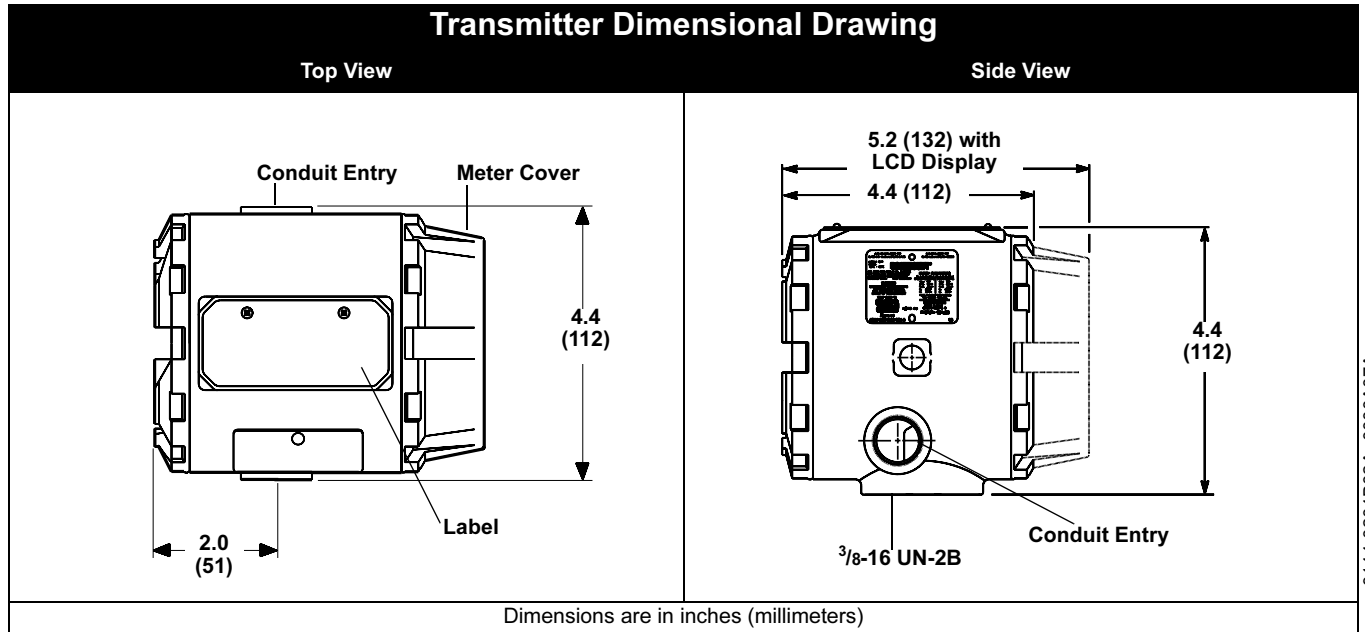

## Optional Transmitter Mounting Brackets

### Option Code B4 Bracket

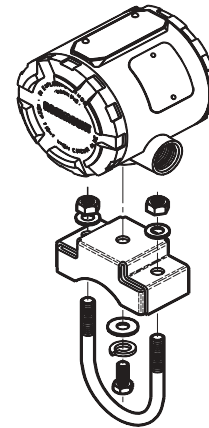
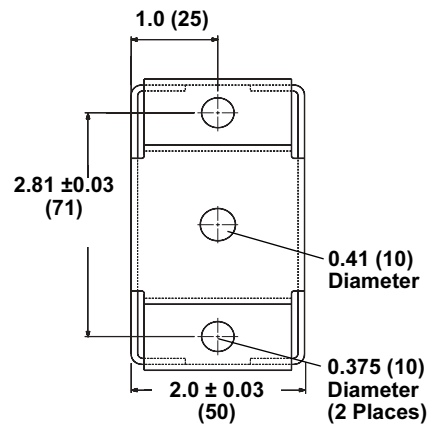
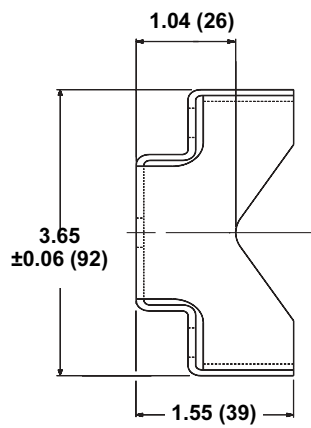

### Option Code B5 Bracket

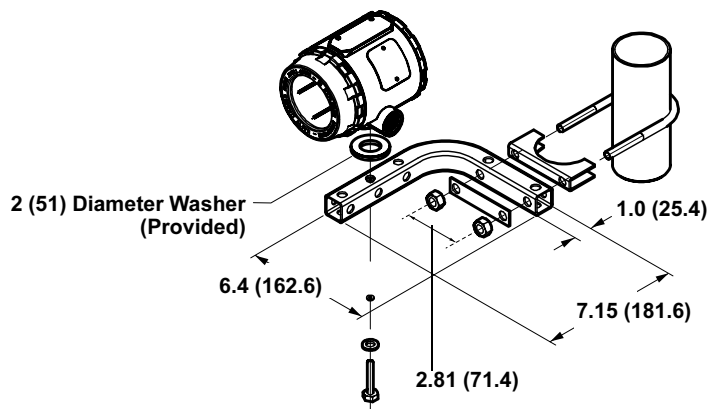

Dimensions are in inches (millimeters)

3044-2101A01A; B01B, 3144-3144A14A.

3144-1081A01A

FIGURE 1. HART / 4–20 mA Wiring Diagram

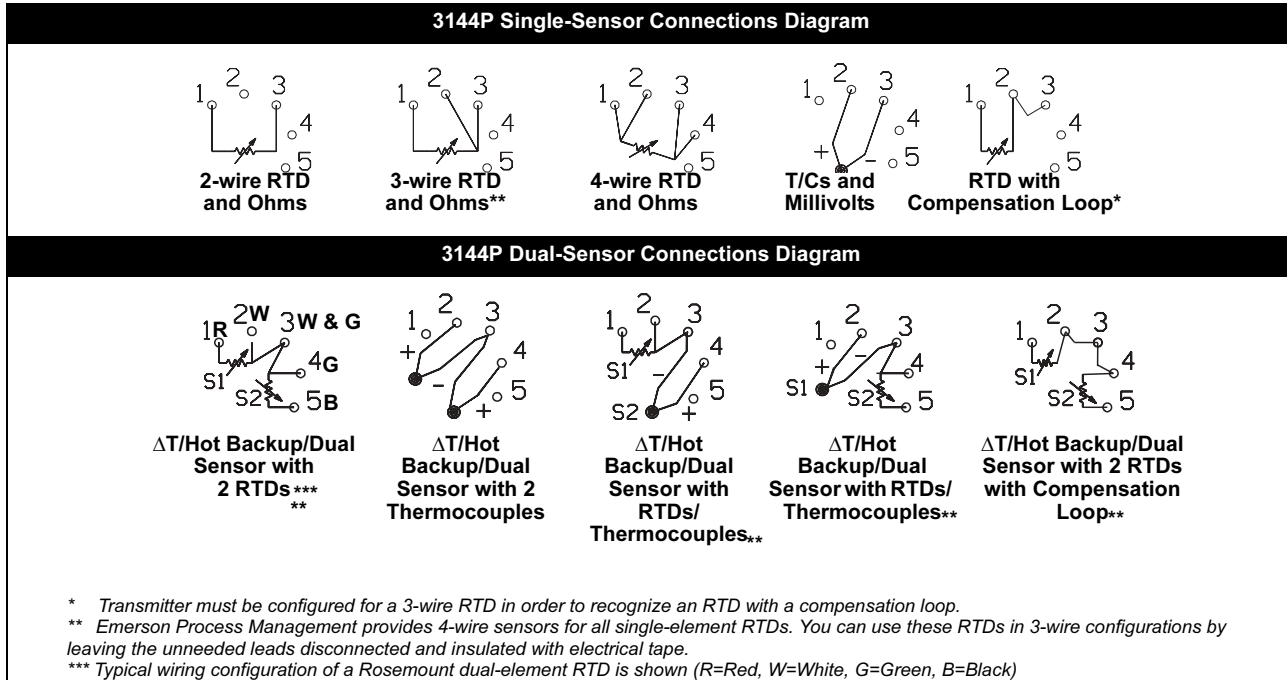
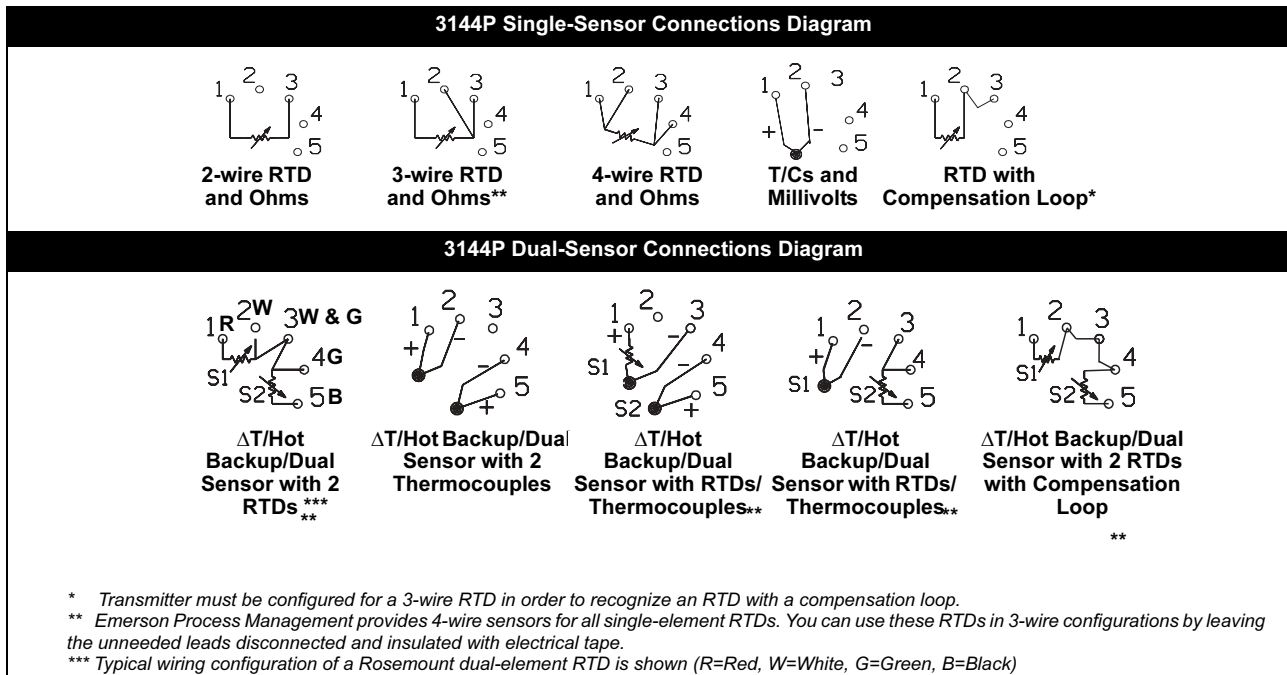

FIGURE 2. FOUNDATION Fieldbus Wiring Diagram



## Rosemount 3144P

## ORDERING INFORMATION

Model	Product Description
3144P	Temperature Transmitter
Transmitter Housing Type/Conduit Entry	
D1	Field Mount Housing (Dual-Compartment), Aluminum, 1/2–14 NPT
D2	Field Mount Housing (Dual-Compartment), Aluminum, M20 x 1.5 (CM20)
D3	Field Mount Housing (Dual-Compartment), Aluminum, PG 13.5 (PG11)
D4	Field Mount Housing (Dual-Compartment), Aluminum, JIS G 1/2
D5	Field Mount Housing (Dual-Compartment), Stainless Steel, 1/2–14 NPT
D6	Field Mount Housing (Dual-Compartment), Stainless Steel, M20 x 1.5 (CM20)
D7	Field Mount Housing (Dual-Compartment), Stainless Steel, PG 13.5 (PG11)
D8	Field Mount Housing (Dual-Compartment), Stainless Steel, JIS G 1/2
Code	Output
A	4–20 mA with Digital Signal based on <i>HART</i> protocol
B	4 – 20 mA Safety Certified with digital signal based on <i>HART</i> protocol
F	<i>FOUNDATION</i> fieldbus digital signal (includes 3 AI function blocks and Backup Link Active Scheduler)
Code	Measurement Type Configuration
1	Single-Sensor Input
2	Dual-Sensor Input
Code	Product Certifications
NA	No Approval
E5	FM explosion-proof and non incendive approval
I5 <sup>(1)</sup>	FM intrinsic safety and non-incendive (includes standard I.S. and FISCO for fieldbus units)
K5 <sup>(1)</sup>	FM intrinsic safety, non-incendive, and explosion-proof combination (includes standard I.S. and FISCO for fieldbus units)
KB <sup>(1)</sup>	FM and CSA intrinsic safety, explosion-proof & non-incendive combination (includes standard IS and FISCO for fieldbus units)
I6 <sup>(1)</sup>	CSA intrinsic safety and FISCO Division 2 (includes standard IS and FISCO for fieldbus units)
K6 <sup>(1)</sup>	CSA intrinsic safety, FISCO Division 2, and explosion-proof combination (includes standard IS and FISCO for fieldbus units)
E1	ATEX flameproof approval
N1	ATEX type n approval
I1 <sup>(1)</sup>	ATEX intrinsic safety (includes standard I.S. and FISCO for fieldbus units)
K1 <sup>(1)</sup>	ATEX intrinsic safety, flameproof, and Type n approval combination (includes standard IS and FISCO for fieldbus units)
ND	ATEX dust ignition proof approval
KA <sup>(1)</sup>	ATEX/CSA intrinsic safety and explosion-proof combination (includes standard I.S. and FISCO for fieldbus units.)
E7	SAA flameproof approval
N7	SAA type n approval
I7 <sup>(1)(3)</sup>	SAA intrinsic safety – <i>HART</i> only
K7 <sup>(1)(2)</sup>	SAA intrinsic safety, flameproof, and type n combination (includes standard IS & FISCO for FF)—consult for fieldbus availability
I2 <sup>(3)</sup>	CEPEL intrinsic safety approval
E4 <sup>(3)</sup>	JIS flameproof approval (requires either housing code D4 or D8)

## Reference Manual

00809-0100-4021, Rev DA  
November 2004

## Rosemount 3144P

Code	Options
<b>PlantWeb Functionality</b>	
A01	Regulatory control suite: PID with autotune, arithmetic, signal characterizer, input selector – <i>FOUNDATION</i> fieldbus only
D01	Diagnostics suite: SPM diagnostics, drift alert – <i>FOUNDATION</i> fieldbus only
<b>Mounting Bracket</b>	
B4	Universal mounting bracket for 2-inch pipe and panel mounting—SST bracket and bolts
B5	Universal “L” mounting bracket for 2-inch pipe mounting—SST bracket and bolts
<b>Meter</b>	
M5	LCD display
<b>External Ground Lug</b>	
G1	External ground lug assembly (See “External Ground Screw Assembly” on page A-3.)
<b>Integral Transient Protector</b>	
T1	Integral transient protector
<b>Custom Software Configuration Request</b>	
C1 <sup>(2)</sup>	Factory enters date, descriptor, and message fields (CDS required with order)
<b>50 Hz Line Voltage Filter Enabled</b>	
F5	50 Hz line voltage filter
<b>NAMUR Compliant Alarm Failure</b>	
A1	Analog output levels compliant with NAMUR recommendation NE-43, June 1996. Alarm configuration <b>high</b> – <i>HART</i> only
CN	Analog output levels compliant with NAMUR recommendation NE-43, June 1996. Alarm configuration <b>low</b> – <i>HART</i> only
<b>Low Alarm</b>	
C8	Analog output levels compliant with Rosemount standard. Alarm configuration <b>low</b> – <i>HART</i> only
<b>Transmitter-Sensor Matching</b>	
C2	Transmitter-Sensor Matching—trim to specific Rosemount RTD calibration schedule
C7	Trim to special non-standard sensor (special sensor—customer must provide sensor information)
<b>Five Point Calibration Data</b>	
C4	5-point calibration (use option code Q4 to generate a calibration certificate)
<b>Calibration Certification</b>	
Q4	Calibration certificate (3-point standard; use code C4 with Q4 option for a five point calibration certificate)
QP	Calibration certificate and tamper evident seal
<b>Dual-Input Custom Configuration (only with measurement type option code 2)</b>	
U1 <sup>(4)</sup>	<i>Hot Backup</i>
U2	Average temperature with <i>Hot Backup</i> and Sensor Drift Alert – warning mode
U3	Average temperature with <i>Hot Backup</i> and Sensor Drift Alert – alarm mode
U4	Two independent sensors
U5	Differential temperature
U6 <sup>(4)</sup>	Average temperature
U7 <sup>(4)</sup>	First good temperature
U8 <sup>(4)</sup>	Minimum temperature – <i>FOUNDATION</i> fieldbus only
U9 <sup>(4)</sup>	Maximum temperature – <i>FOUNDATION</i> fieldbus only
<b>Special Certifications</b>	
QS	Quality Documentation for Safety Instrumented Systems – <i>HART</i> only
<b>Conduit Electrical Connector</b>	
GE <sup>(5)</sup>	M12, 4-pin, Male Connector ( <i>eurofast</i> <sup>®</sup> )
GM <sup>(5)</sup>	A size Mini, 4-pin, Male Connector ( <i>minifast</i> <sup>®</sup> )
<b>Assembly</b>	
XA	Sensor specified separately and assembled to transmitter
<b>Typical Model Number: 3144P D1 A 1 E5 B4 M5</b>	

(1) When IS approval is ordered on a *FOUNDATION* fieldbus, both standard IS and FISCO IS approvals apply. The device label is marked appropriately.

(2) Consult factory for availability when ordering with *FOUNDATION* fieldbus models.

(3) Consult factory for availability when ordering with *HART* or *FOUNDATION* fieldbus models.

(4) Codes U1 and U6 for *HART* transmitters will not have drift alert enabled; option codes U1, U6, U7, U8, and U9 for *FOUNDATION* fieldbus transmitters will have drift alert enabled.

(5) Not available with certain hazardous location certifications. Contact an Emerson Process Management representative for details.

## Rosemount 3144P

**Standard Configuration**

Both standard and custom configuration settings may be changed. Unless specified, the transmitter will be shipped as follows:

Standard Configuration	
4 mA value / Lower Range (HART / 4–20 mA)	0 °C
20 mA value / Upper Range (HART / 4–20 mA)	100 °C
Damping	5 seconds
Output	Linear with temperature / FOUNDATION fieldbus
Failure Mode (HART / 4–20 mA)	High
Line Voltage Filter	60 Hz
Software Tag	See "Tagging"
Optional Integral Meter	Units and mA / Sensor 1 units
Single Sensor option	
Sensor Type	4-wire Pt 100 $\alpha = 0.00385$ RTD
Primary Variable (HART / 4–20 mA)	Sensor 1
Secondary Variable	Terminal Temperature
Tertiary Variable	Not Available
Quaternary Variable	Not Available
Dual-Sensor option	
Sensor Type	Two 3-wire Pt 100 $\alpha = 0.00385$ RTD
Primary Variable (HART / 4–20 mA)	Sensor 1
Secondary Variable	Sensor 2
Tertiary Variable	Terminal Temperature
Quaternary Variable	Not Used

**Custom Configuration**

The 3144P transmitter can be ordered with custom configuration. The table below lists the requirements necessary to specify a custom configuration.

Option Code	Requirements/Specification
C1: Factory Data <sup>(1)</sup>	Date: day/month/year Descriptor: 16 alphanumeric character Message: 32 alphanumeric character Custom Alarm Levels can be specified for configuration at the factory.
C2: Transmitter Sensor Matching	The transmitters are designed to accept Callendar-van Dusen constants from a calibrated RTD schedule and generate a custom curve to match any specific sensor curve. Specify a Series 68, 65, or 78 RTD sensor on the order with a special characterization curve (V or X8Q4 option). These constants will be programmed into the transmitter with this option.
C4: Five Point Calibration	Will include five-point calibration at 0, 25, 50, 75, and 100% analog and digital output points. Use with option code Q4 to obtain a Calibration Certificate.
C7: Special Sensor	Used for non-standard sensor, adding a special sensor or expanding input. Customer must supply the non-standard sensor information. Additional special curve will be added to sensor curve input choices.
A1: NAMUR- Compliant, high alarm	Analog output levels compliant with NAMUR. Alarm is set to fail high.
CN: NAMUR- Compliant, low alarm	Analog output levels compliant with NAMUR. Alarm is set to fail low.
C8: Low Alarm	Analog output levels compliant with Rosemount standard. Alarm is set to fail low
F5: 50 Hz Line Filter	Calibrated to 50 Hz line voltage filter.

(1) CDS required



To custom configure the 3144P with the dual-sensor option transmitter for one of the applications described below, indicate the appropriate option code in the model number. If a sensor type is not specified, the transmitter will be configured for two 3-wire Pt 100 ( $\alpha = 0.00385$ ) RTDs if any of the following option codes are selected.

**Option Code U1  
Hot Backup Configuration**

Primary Usage	Primary usage sets the transmitter to automatically use sensor 2 as the primary input if sensor 1 fails. Switching from sensor 1 to sensor 2 is accomplished without any effect on the analog signal.
Primary Variable	Sensor 1
Secondary Variable	Sensor 2
Tertiary Variable	Terminal Temperature
Quaternary Variable	Not Used

**Option Code U2 Average Temperature with Hot Backup and Sensor Drift Alarm – Warning Mode**

Primary Usage	Critical applications, such as safety interlocks and control loops. Outputs the average of two measurements and alerts if temperature difference exceeds the set maximum differential (sensor drift alarm). If a sensor fails, an alert will be sent and the primary variable will hold working sensor measurement.
Primary Variable	Sensor Average
Secondary Variable	Sensor 1
Tertiary Variable	Sensor 2
Quaternary Variable	Terminal Temperature

**Option Code U3 Average Temperature with Hot Backup and Sensor Drift Alarm – Alarm Mode**

Primary Usage	Critical applications, such as safety interlocks and control loops. Outputs the average of two measurements and alerts if temperature difference exceeds the set maximum differential (sensor drift alarm).
Primary Variable	Sensor Average
Secondary Variable	Sensor 1
Tertiary Variable	Sensor 2
Quaternary Variable	Terminal Temperature

**Option Code U4  
Two Independent Sensors**

Primary Usage	Used in non-critical applications where the digital output is used to measure two separate process temperatures.
Primary Variable	Sensor 1
Secondary Variable	Sensor 2
Tertiary Variable	Terminal Temperature
Quaternary Variable	Not Used

**Option Code U5  
Differential Temperature**

Primary Usage	The differential temperature of two process temperatures are configured as the primary variable.
Primary Variable	Differential Temperature
Secondary Variable	Sensor 1
Tertiary Variable	Sensor 2
Quaternary Variable	Terminal Temperature

**Option Code U6  
Average Temperature**

Primary Usage	When average measurement of two different process temperatures is required. If a sensor fails, an alert will be sent and the primary variable will hold the measurement of the working sensor.
Primary Variable	Sensor Average
Secondary Variable	Sensor 1
Tertiary Variable	Sensor 2
Quaternary Variable	Terminal Temperature

---

## Appendix B Product Certifications

---

Rosemount 3144P With HART / 4–20 mA .....	page B-1
Rosemount 3144P With Foundation fieldbus .....	page B-6
Installation Drawings .....	page B-9

---

### ROSEMOUNT 3144P WITH HART / 4–20 mA

#### Approved Manufacturing Locations

Rosemount Inc. – Chanhassen, Minnesota, USA  
Rosemount Temperature GmbH – Germany  
Emerson Process Management Asia Pacific – Singapore

#### European Union Directive Information

The EC declaration of conformity for all applicable European directives for this product can be found on the Rosemount website at [www.rosemount.com](http://www.rosemount.com). A hard copy may be obtained by contacting your local sales representative.

#### ATEX Directive (94/9/EC)

Rosemount Inc. complies with the ATEX Directive.

#### Electro Magnetic Compatibility (EMC) (89/336/EEC)

EN 50081-1: 1992; EN 50082-2:1995; EN 61326-1:1997 – Industrial

#### Hazardous Locations Installations

#### North American Certifications

##### Factory Mutual (FM) Approvals

- I5 FM Intrinsic Safety and Non-incendive:  
Intrinsically Safe for Class I/II/III, Division 1, Groups A, B, C, D, E, F, and G.  
Temperature codes: T4A ( $T_{amb} = -60$  to  $60$  °C)  
T5 ( $T_{amb} = -60$  to  $50$  °C)  
Zone Marking: Class I, Zone 0, AEx ia IIC  
T4 ( $T_{amb} = -50$  to  $60$  °C)  
Intrinsically Safe when installed in accordance with control drawing 03144-0321.  
Non-incendive for use in Class I, Division 2, Groups A, B, C, and D.  
Suitable for use in Class II / III, Division 2, Groups F and G.  
Non-incendive when installed in accordance with Rosemount drawings 03144-0321.

Temperature codes: T6 ( $T_{amb} = -60$  to  $60$  °C),  
T5 ( $T_{amb} = -60$  to  $85$  °C)

- E5 Explosion Proof for Class I, Division 1, Groups A, B, C, D.  
Dust Ignition-Proof for use in Class II/III, Division 1, Groups E, F, and G.  
Explosion-Proof and Dust Ignition-Proof when installed in accordance with Rosemount drawing 03144-0320. Indoor and outdoor use. NEMA Type 4X.

Temperature code: T5 ( $T_{amb} = -50$  to  $85\text{ }^{\circ}\text{C}$ )

---

**NOTE**

For Group A, seal all conduits within 18 inches of enclosure; otherwise, conduit seal not required for compliance with NEC 501-5a(1).

---

Non-incendive for use in Class I, Division 2, Groups A, B, C, and D.  
Suitable for use in Class II/III, Division 2, Groups F and G. Non-incendive when installed in accordance with Rosemount drawing 03144-0321.



Temperature codes: T5 ( $T_{amb} = -60$  to  $85\text{ }^{\circ}\text{C}$ ),

T6 ( $T_{amb} = -60$  to  $60\text{ }^{\circ}\text{C}$ )

*Canadian Standards Association (CSA) Approvals*

- I6 CSA Intrinsic Safety and Division 2  
Intrinsically Safe for Class I, Division 1, Groups A, B, C, and D; Class II, Division 1, Groups E, F, and G; Class III, Division 1; Suitable for Class I, Division 2, Groups A, B, C, and D. Intrinsically Safe and Division 2 when installed per Rosemount drawing 03144-0322.
- K6 Combination of I6 and the following:  
Explosion Proof for Class I, Division 1, Groups A, B, C, and D; Class II, Division 1, Groups E, F, and G; Class III, Division 1 hazardous locations.  
Factory sealed.

**European Certifications**

- E1 CENELEC / ATEX Flameproof Approval (Zone 1)  
Certificate Number: KEMA01ATEX2181  
ATEX Category Marking  II 2 G  
EEx d IIC T6 ( $T_{amb} = -40$  to  $70\text{ }^{\circ}\text{C}$ )  
EEx d IIC T5 ( $T_{amb} = -40$  to  $80\text{ }^{\circ}\text{C}$ )  
Max supply voltage: 55 Vdc
- ND CENELEC / ATEX Dust Ignition Proof Approval  
Certificate Number: KEMA01ATEX2205  
ATEX Category Marking  II 1 D  
T95  $^{\circ}\text{C}$  ( $T_{amb} = -40$  to  $85\text{ }^{\circ}\text{C}$ )  
Max supply voltage: 55 Vdc

- N1 CENELEC / ATEX Type n Approval (Zone 2)  
 Certificate Number: BAS01ATEX3432X  
 ATEX Category Marking Ⓜ II 3 G  
 EEx nL IIC T6 ( $T_{amb} = -40$  to  $50$  °C)  
 EEx nL IIC T5 ( $T_{amb} = -40$  to  $75$  °C)  
 $U_i = 55V$

Special Conditions for Safe Use (X):

The transmitter is not capable of withstanding the 500 v insulating test required by Clause 9.1 of EN50021:1999. This condition must be taken into account during installation.

- I1 CENELEC / ATEX Intrinsic Safety Approval (Zone 0)  
 Certificate Number: BAS01ATEX1431X  
 ATEX Category Marking Ⓜ II 1 G  
 EEx ia IIC T6 ( $T_{amb} = -60$  to  $50$  °C)  
 EEx ia IIC T5 ( $T_{amb} = -60$  to  $75$  °C)

Table B-1. Input Entity Parameters

Power/Loop		Sensor	
$U_i = 30$ V dc	$C_i = 5$ nF	$U_o = 13.6$ V	$C_i = 78$ nF
$I_i = 300$ mA	$L_i = 0$	$I_o = 56$ mA	$L_i = 0$
$P_i = 1.0$ W		$P_o = 190$ mW	

Special Conditions for Safe Use (x):

The transmitter is not capable of withstanding the 500V insulation test as defined in Clause 6.4.12 of EN50 020. This condition must be taken into account during installation.

### Australian Certifications

Standard Australia Quality Assurance Services (SAA)

- E7 Flameproof Approval  
 Certificate Number: AUS Ex 02.3813X  
 Ex d IIC T6 ( $T_{amb} = -20$  to  $60$  °C)  
 IP66

Special Conditions for Safe Use (x):

1. Apparatus must be installed in accordance to Rosemount drawing 03144-0325.

2. If the sensor is intended to be remote mounted, it should be installed in a suitable Standards Australia certified Flame-Proof enclosure and installed in accordance with Rosemount drawing 03144-0325.

3. Standards Australia certified cable glands or conduit adapters must be used when connecting to external circuits. Where only one conduit entry is used for connection to external circuits, the unused entry is to be closed by means of a blanking plug supplied by Rosemount or by a suitable Standards Australia certified blanking plug.

N7 Type N Approval  
 Certificate Number: AUS Ex 02.3794X  
 Ex n IIC T6 ( $T_{amb} = -60$  to  $50$  °C)  
 Ex n IIC T5 ( $T_{amb} = -60$  to  $75$  °C)  
 IP66  
 $U_n = 55$  V  
 $P_n = 1.3$  W

I7 Intrinsic Safety Approval  
 Certificate Number: AUS Ex 02.3794X  
 Ex ia IIC T6 ( $T_{amb} = -60$  to  $50$  °C)  
 Ex ia IIC T5 ( $T_{amb} = -60$  to  $75$  °C)

Table B-2. Input Entity Parameters

Power/Loop		Sensor	
$U_i = 30$ V dc	$C_i = 0.005$ $\mu$ F	$U_o = 13.6$ V	$C_o = 0.66$ $\mu$ F
$I_i = 300$ mA	$L_i = 20$ $\mu$ H	$I_o = 100$ mA	$L_o = 1.9$ mH
$P_i = 1.0$ W		$P_o = 80$ mW	

**Special Conditions for Safe Use (x):**

1. For options using the transient protection board, the apparatus should be connected to earth with a copper conductor of  $4$  mm<sup>2</sup> or greater.
2. For the label with more than one type of marking on it, upon completion of commissioning the apparatus the irrelevant marking code(s) shall be permanently scribed off.

**Brazilian Certifications**

*Centro de Pesquisas de Energia Eletrica (CEPEL) Approval*

I2 CEPEL Intrinsic Safety – Consult factory for availability.

**Japanese Certifications**

*Japanese Industrial Standard (JIS) Flameproof Certification*

E4 Without sensor: Ex d IIB T6 ( $T_{amb} = -20$  to  $55$  °C)  
 With sensor: Ex d IIB T4 ( $T_{amb} = -20$  to  $55$  °C)

**Combination Certifications**

Stainless steel certification tag is provided when optional approval is specified. Once a device labeled with multiple approval types is installed, it should not be reinstalled using any other approval types. Permanently mark the approval label to distinguish it from unused approval types.

- KA Combination of K1 and K6
- KB Combination of K5 and K6
- K1 Combination of E1, N1, and I1
- K7 Combination of E7, N7, and I7
- K5 Combination of I5 and E5

**Additional Certifications**

*American Bureau of Shipping (ABS) Type Approval*

ABS Type Approval for temperature measurements in hazardous locations on ABS Classed Vessels, Marine and Offshore Installations. Type Approval is based on Factory Mutual (FM) Approvals; therefore, specify order code K5. Please contact your Emerson Process Management representative if a copy of the certification is required.

*Det Norske Veritas (DNV) Type Approval for Shipboard and Offshore Installations*

DNV rules for classifications of ships and mobile offshore units for temperature measurements in the following locations:

Table B-3. Applications / Limitations

Location	Class
Temperature	D
Humidity	B
Vibration	B/C
Enclosure	D

**NOTE**

The transient protector (option code T1) is required when requesting DNV Type Approval. Additionally, hazardous locations approvals may be required (based on shipboard location) and will need to be specified by the Hazardous Locations option code.

Please contact your Emerson Process Management representative if a copy of the certification is required.

**GOSTANDART**

Tested and approved by Russian Metrological Institute.

# Rosemount 3144P

---

## ROSEMOUNT 3144P WITH FOUNDATION FIELDBUS

### Approved Manufacturing Locations

Rosemount Inc. – Chanhassen, Minnesota, USA  
 Rosemount Temperature GmbH – Germany  
 Emerson Process Management Asia Pacific – Singapore

### European Union Directive Information

The EC declaration of conformity for all applicable European at [www.rosemount.com](http://www.rosemount.com). A hard copy may be obtained by contacting your local sales representative. Directives for this product can be found on the Rosemount website

#### ATEX Directive (94/9/EC)

Rosemount Inc. complies with the ATEX Directive.

#### Electro Magnetic Compatibility (EMC) (89/336/EEC)

EN 50081-1: 1992; EN 50082-2:1995; EN 61326-1:1997 – Industrial

### Hazardous Locations Installations

#### North American Certifications

##### Factory Mutual (FM) Approvals

- I5 FM Intrinsic Safety / FISCO and Non-incendive Intrinsically Safe / FISCO for use in Class I, II, III, Division 1, Groups A, B, C, D, E, F, and G;  
 Temperature code: T4 ( $T_{amb} = -60\text{ °C to }60\text{ °C}$ )  
 Zone marking: Class I, Zone 0, AEx ia IIC T4 ( $T_{amb} = -50\text{ °C to }60\text{ °C}$ )  
 Intrinsically safe when installed in accordance with control drawing 003144-5075.

Non-incendive for use in Class, Division 2, Groups A,B,C and D; Suitable for use in Class II/III, Division 2, Groups F and G Non-incendive when installed in accordance with Rosemount drawing 03144-5075.

Temperature Class: T6 ( $T_{amb} = -60\text{ °C to }50\text{ °C}$ );  
 T5 ( $T_{amb} = -60\text{ °C to }75\text{ °C}$ )

- E5 Explosion Proof for Class I, Division 1, Groups A, B, C, and D.  
 Dust Ignition-Proof for use in Class II/III, Division 1, Groups E, F, and G.  
 Explosion-Proof and Dust Ignition-Proof when installed in accordance with Rosemount drawing 03144-0320. Indoor and outdoor use. NEMA Type 4X.

Temperature code: T5 ( $T_{amb} = -50\text{ to }85\text{ °C}$ )

---

#### NOTE

For Group A, seal all conduits within 18 inches of enclosure; otherwise, conduit seal not required for compliance with NEC 501-5a(1).

---

Non-incendive for use in Class I, Division 2, Groups A, B, C, and D.  
 Suitable for use in Class II/III, Division 2, Groups F and G. Non-incendive when installed in accordance with Rosemount drawing 03144-5075.



Temperature codes: T5 ( $T_{amb} = -60$  to  $75$  °C),  
T6 ( $T_{amb} = -60$  to  $50$  °C)

*Canadian Standards Association (CSA) Approvals*

I6 CSA Intrinsic Safety / FISCO and Division 2  
Intrinsically Safe / FISCO for use in Class I, Division 1, Groups A, B, C, and D; Class II, Division 1, Groups E, F, and G; Class III, Division 1.

Temperature Class: T4 ( $T_{amb} = -50$  °C to  $60$  °C)  
Suitable for Class I, Division 2, Groups A, B, C, and D.

Temperature Class: T5 ( $T_{amb} = -60$  °C to  $85$  °C);  
T6 ( $T_{amb} = -60$  °C to  $60$  °C)

Intrinsic Safety / FISCO and Division 2 when installed per Rosemount drawing 03144-5076.

K6 Combination of I6 and the following:  
Explosion Proof for Class I, Division 1, Groups A, B, C, and D; Class II, Division 1, Groups E, F, and G; Class III, Division 1 hazardous locations.  
Factory sealed.

**European Certifications**

E1 CENELEC / ATEX Flameproof Approval (Zone 1)  
Certificate Number: KEMA01ATEX2181  
ATEX Category Marking Ⓜ II 2 G  
EEx d IIC T6 ( $T_{amb} = -40$  to  $70$  °C)  
EEx d IIC T5 ( $T_{amb} = -40$  to  $80$  °C)  
Max supply voltage: 55 Vdc

ND CENELEC / ATEX Dust Ignition Proof Approval  
Certificate Number: KEMA01ATEX2205  
ATEX Category Marking Ⓜ II 1 D  
T95 °C ( $T_{amb} = -40$  to  $85$  °C)  
Max supply voltage: 55 Vdc

N1 CENELEC / ATEX Type n Approval (Zone 2)  
Certificate Number: Baseefa03ATEX0709  
ATEX Category Marking Ⓜ II 3 G  
EEx nA nL IIC T5 ( $T_{amb} = -40$  to  $75$  °C)  
 $U_i = 42.4$  V maximum

I1 CENELEC / ATEX Intrinsic Safety / FISCO  
Approval (Zone 0)  
Certificate Number: Baseefa03ATEX0708X  
ATEX Category Marking Ⓜ II 1 G  
EEx ia IIC T4 ( $T_{amb} = -60$  to  $60$  °C)

Table B-4. Input Entity Parameters

Power/Loop	FISCO Power/Loop	Sensor
$U_i = 30 \text{ V dc}$	$U_i = 17.5 \text{ V dc}$	$U_o = 13.9 \text{ V}$
$I_i = 300 \text{ mA}$	$I_i = 380 \text{ mA}$	$I_o = 23 \text{ mA}$
$P_i = 1.3 \text{ W}$	$P_i = 5.32 \text{ W}$	$P_o = 79 \text{ mW}$
$C_i = 2.1 \text{ nF}$	$C_i = 2.1 \text{ nF}$	$C_i = 7.7 \text{ nF}$
$L_i = 0$	$L_i = 0$	$L_i = 0$

**Special Conditions for Safe Use (x):**

1. The apparatus enclosure may contain light metals. The apparatus must be installed in such a manner as to minimize the risk of impact or friction with other metal surfaces.
2. A Transient protection device can be fitted as an option, in which the equipment will not pass the 500V test.

**Australian Certifications**

Standard Australia Quality Assurance Services (SAA)

**E7 Flameproof Approval**

Certificate Number: AUS Ex 02.3813X  
Ex d IIC T6 ( $T_{amb} = -20 \text{ to } 60 \text{ }^\circ\text{C}$ )  
IP66

**Special Conditions for Safe Use (x):**

1. Apparatus must be installed in accordance to Rosemount drawing 03144-0325.
2. If the sensor is intended to be remote mounted, it should be installed in a suitable Standards Australia certified Flame-Proof enclosure and installed in accordance with Rosemount drawing 03144-0325.
3. Standards Australia certified cable glands or conduit adapters must be used when connecting to external circuits. Where only one conduit entry is used for connection to external circuits, the unused entry is to be closed by means of a blanking plug supplied by Rosemount or by a suitable Standards Australia certified blanking plug.

**N7 Type n Approval (Zone 2)**

Certificate Number: AUS Ex 02.3794X  
Ex n IIC T5 ( $T_{amb} = -60^\circ\text{C to } 75^\circ\text{C}$ )  
Ex n IIC T6 ( $T_{amb} = -60^\circ\text{C to } 50^\circ\text{C}$ )  
IP66

**Special Conditions for Safe Use:**

1. For the lightning protection board, the apparatus should be bonded to earth with a copper conductor of  $4\text{mm}^2$  or greater.
2. Input/Output parameters for non-sparking protection model Ex n:  
Maximum input voltage  $U_n = 55\text{V}$ .  
Maximum input power  $P_n = 1.3\text{W}$ .

**Brazilian Certifications**

*Centro de Pesquisas de Energia Eletrica (CEPEL) Approval*

I2 CEPEL Intrinsic Safety – Consult factory for availability.

**Japanese Certifications**

*Japanese Industrial Standard (JIS) Flameproof Certification*

E4 Consult factory for availability.

**Combination Certifications**

Stainless steel certification tag is provided when optional approval is specified. Once a device labeled with multiple approval types is installed, it should not be reinstalled using any other approval types. Permanently mark the approval label to distinguish it from unused approval types.

KA Combination of K1 and K6

KB Combination of K5 and K6

K1 Combination of E1, N1, and I1

K7 Combination of E7, N7, and I7

K5 Combination of I5 and E5.

**INSTALLATION  
DRAWINGS**

Rosemount Drawing 03144-0320, 1 Sheet:  
Factory Mutual Explosion-proof Installation Drawing.

Rosemount Drawing 03144-0321, 3 Sheets:  
Factory Mutual Intrinsic Safety and Nonincendive Field Circuit Configuration  
Installation Drawing.

Rosemount Drawing 03144-5075, 4 Sheets:  
Factory Mutual 3144 Fieldbus Intrinsic Safety / FISCO Installation Drawing.

Rosemount Drawing 03144-0322, 1 Sheet:  
CSA Intrinsic Safety Approval Configuration Installation Drawing.

Rosemount Drawing 03144-5076, 4 Sheets:  
CSA 3144 Fieldbus Intrinsic Safety / FISCO Installation Drawing.

Rosemount Drawing 03144-0324, 1 Sheet:  
KEMA/CENELEC Flame-proof Temperature Measurement Assembly  
Installation Drawing.

Rosemount Drawing 03144-0325, 1 Sheet:  
SAA Flameproof Temperature Measurement Assembly Installation Drawing.

---

**IMPORTANT**

Once a device labeled with multiple approval types is installed, it should not be reinstalled using any of the other labeled approval types. To ensure this, the approval label should be permanently marked to distinguish the used from the unused approval type(s).

---

# Rosemount 3144P

**Reference Manual**  
00809-0100-4021, Rev DA  
November 2004

Figure B-1. Factory Mutual Explosion-Proof Installation Drawing 03144-0320, Rev. AB

CONFIDENTIAL AND PROPRIETARY INFORMATION IS CONTAINED HEREIN AND MUST BE HANDLED ACCORDINGLY	REVISIONS				
	REV	DESCRIPTION	CHG. NO.	APP'D	DATE
	AB	ADD T5 TO NOTE 5	RTC1012632	D.B.	2/21/02

**HAZARDOUS (CLASSIFIED) LOCATION**

REMOTE MOUNT SENSOR CONFIGURATION

DIRECT MOUNT SENSOR CONFIGURATION

5. MODEL 3144P FM APPROVAL CLASSIFICATION:  
EXPLOSION PROOF FOR CLASS I, DIVISION 1, GROUPS A, B, C, & D (T5)  
DUST-IGNITION PROOF FOR CLASS II/III, DIVISION 1, GROUPS E, F, & G;  
NONINCENDIVE FOR CLASS I, DIVISION 2, GROUPS A, B, C, & D (T4A).  
NEMA ENCLOSURE TYPE 4X  
AMBIENT TEMP. LIMITS: -50°C TO +85°C.
4. FOR FIELD WIRING CONNECTIONS IN AMBIENT TEMPERATURES ABOVE 60°, USE WIRING RATED FOR AT LEAST 90°C.
3. TEMPERATURE SENSOR ASSEMBLY MUST BE FM APPROVED FOR APPROPRIATE AREA CLASSIFICATION.
2. ALL CONDUIT THREADS MUST BE ASSEMBLED WITH A MINIMUM OF FIVE FULL THREADS ENGAGEMENT.

1. INSTALL PER NATIONAL ELECTRICAL CODE (NEC). FOR GROUP A, SEAL ALL CONDUITS WITHIN 18 INCHES OF ENCLOSURE; OTHERWISE, CONDUIT SEAL NOT REQUIRED FOR COMPLIANCE WITH NEC 501-5a(1).

CAD MAINTAINED (MicroStation)

UNLESS OTHERWISE SPECIFIED DIMENSIONS IN INCHES [mm]. REMOVE ALL BURRS AND SHARP EDGES. MACHINE SURFACE FINISH I25  -TOLERANCE- .X ± .1 [2,5] .XX ± .02 [0,5] .XXX ± .010 [0,25]  FRACTIONS    ANGLES ± 1/32        ± 2°  DO NOT SCALE PRINT	CONTRACT NO.		<b>ROSEMOUNT®</b> 8200 Market Boulevard • Chanhassen, MN 55317 USA	
	DR. <b>NGA DOAN</b>	6/29/01	TITLE    INSTALLATION DRAWING:	
	CHK'D		MODEL 3144P	
	APP'D. <b>D. BAUSCHKE</b>	7/17/01	FACTORY MUTUAL (FM) EXPLOSIONPROOF	
	APP'D. GOVT.		SIZE    FSCM NO	DWG NO.    03144-0320
		SCALE    N/A	WT.    _____	SHEET 1 OF 1

3144\_3144-0320A01A

Figure B-2. FM Intrinsic Safety and Nonincendive Field Circuit Configuration Installation Drawing 03144-0321, Rev AB. Sheet 1 of 3.

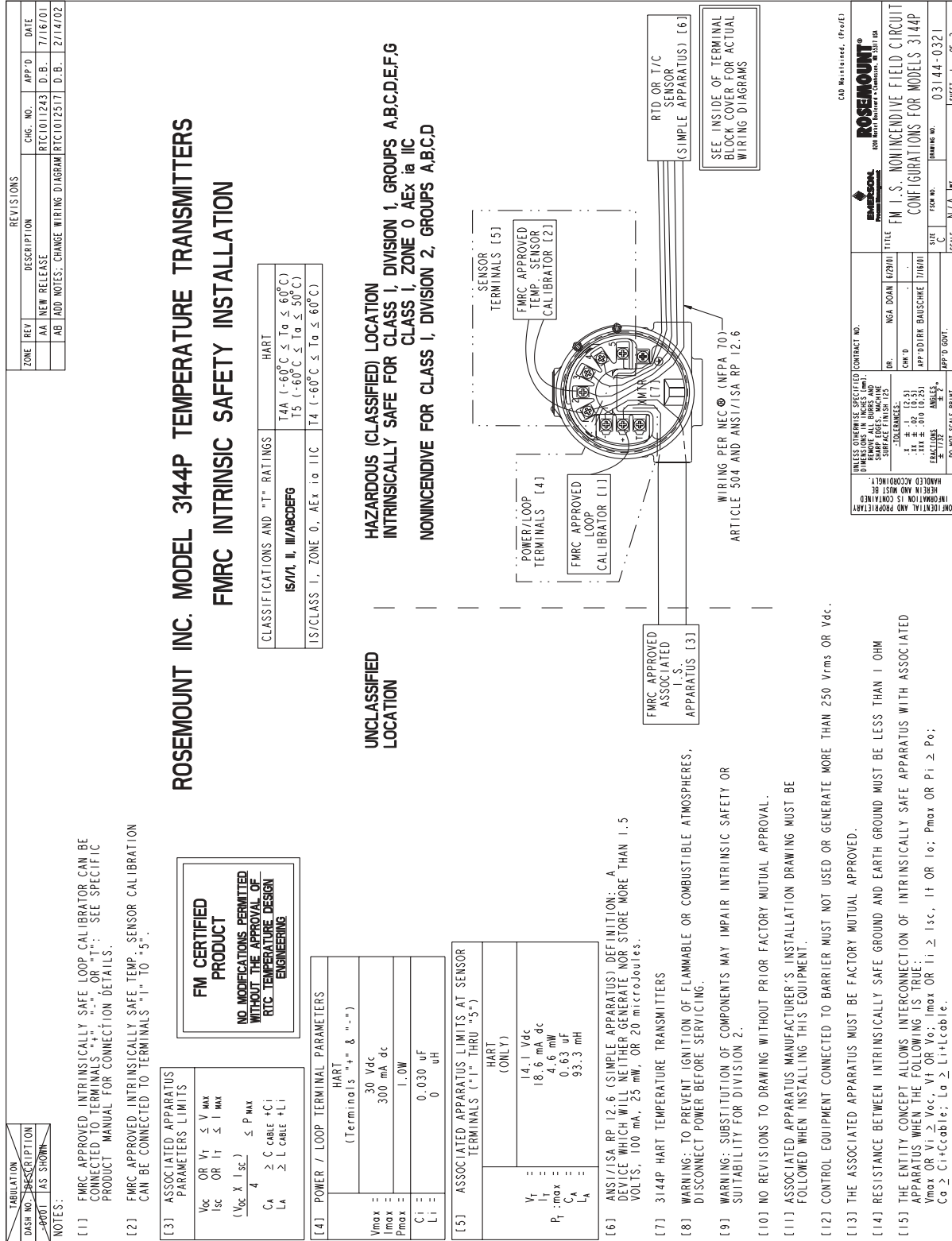

Sheet 2 of 3.

ZONE REV	DESCRIPTION	CHG. NO.	APP'D	DATE
AB	RTIC1012517			

**ROSEMOUNT INC. MODEL 3144P TEMPERATURE TRANSMITTER**  
**FMRC DIV. 2 INSTALLATION OPTIONS**

CLASSIFICATIONS AND "T" RATINGS	HART
N1/11/2/ ABCD	T6 (-60°C ≤ T <sub>o</sub> ≤ 60°C) T4A (-60°C ≤ T <sub>o</sub> ≤ 85°C)

**DIV. 2 HAZARDOUS (CLASSIFIED) LOCATION**  
**SUITABLE FOR CLASS II, III, DIVISION 2, GROUPS F & G**

**UNCLASSIFIED LOCATION**

**OPTION 1**

UNSPECIFIED EQUIPMENT

SEE INSIDE OF TERMINAL BLOCK COVER FOR ACTUAL SENSOR WIRING DIAGRAMS

FMRC DIV. 2 APPROVED RTD OR T/C SENSOR

**OPTION 2**

UNSPECIFIED EQUIPMENT

SEE INSIDE OF TERMINAL BLOCK COVER FOR ACTUAL SENSOR WIRING DIAGRAMS

RTD OR T/C SENSOR (SIMPLE APPARATUS) [6]

**OPTION 3**

FMRC APPROVED ASSOCIATED NONINCENDIVE APPARATUS [3]

SEE INSIDE OF TERMINAL BLOCK COVER FOR ACTUAL SENSOR WIRING DIAGRAMS

RTD OR T/C SENSOR (SIMPLE APPARATUS) [6]

**NOTES:**

[1] FMRC INTRINSICALLY SAFE OR NONINCENDIVE FIELD CIRCUIT APPROVED LOOP CALIBRATOR CAN BE CONNECTED TO TERMINALS "+", "-", "0", OR "T". SEE SPECIFIC PRODUCT MANUAL FOR CONNECTION DETAILS.

[2] FMRC INTRINSICALLY SAFE OR NONINCENDIVE FIELD CIRCUIT APPROVED TEMP. SENSOR CALIBRATION CAN BE CONNECTED TO TERMINALS "1" TO "5".

[3] ASSOCIATED NONINCENDIVE APPARATUS PARAMETERS LIMITS

V <sub>oc</sub> OR V <sub>r</sub> ≤ V <sub>max</sub>
C <sub>A</sub> ≥ C <sub>CABLE</sub> + C <sub>i</sub>
L <sub>A</sub> ≥ L <sub>CABLE</sub> + L <sub>i</sub>

[4] TRANSMITTER POWER/LOOP TERMINAL PARAMETER LIMITS

HART ("+" TO "-")	V <sub>max</sub>
55 Vdc	
C <sub>i</sub> = 0.030 uF	
L <sub>i</sub> = 20 uH	

[5] ASSOCIATED NONINCENDIVE (ANI) FIELD CIRCUIT PARAMETER LIMITS AT SENSOR TERMINALS ("1" THRU "5")

HART (ONLY)	V <sub>r</sub> = 14.1 Vdc
	I <sub>r</sub> = 18.6 mA dc
	P <sub>r-max</sub> = 4.6 mW
	C <sub>A</sub> = 0.63 uF
	L <sub>A</sub> = 93.3 mH

[6] ANSI/ISA RP 12.6 (SIMPLE APPARATUS) DEFINITION: A DEVICE WHICH WILL NEITHER GENERATE NOR STORE MORE THAN 1.5 VOLTS, 100 mA, 25 mW.

[7] 3144P HART TEMPERATURE TRANSMITTERS.

[8] NFPA 70 National Electrical Code® ARTICLE 501-4(b) EXCEPTION: "WIRING IN NONINCENDIVE CIRCUITS SHALL BE PERMITTED USING ANY OF THE METHODS SUITABLE FOR WIRING IN ORDINARY LOCATIONS."

[9] DUST-TIGHT CONDUIT SEAL MUST BE USED WHEN INSTALLED IN CLASS II AND CLASS III ENVIRONMENTS.

Rosemount Inc. 8200 Market Boulevard Chanhassen, MN 55317 USA	SIZE C	FPM NO. N/A	DRAWING NO. 03144-0321	SCALE N/A	SHEET 2 OF 3
---	-----------	----------------	---------------------------	--------------	-----------------

3144\_3144-0321A02A

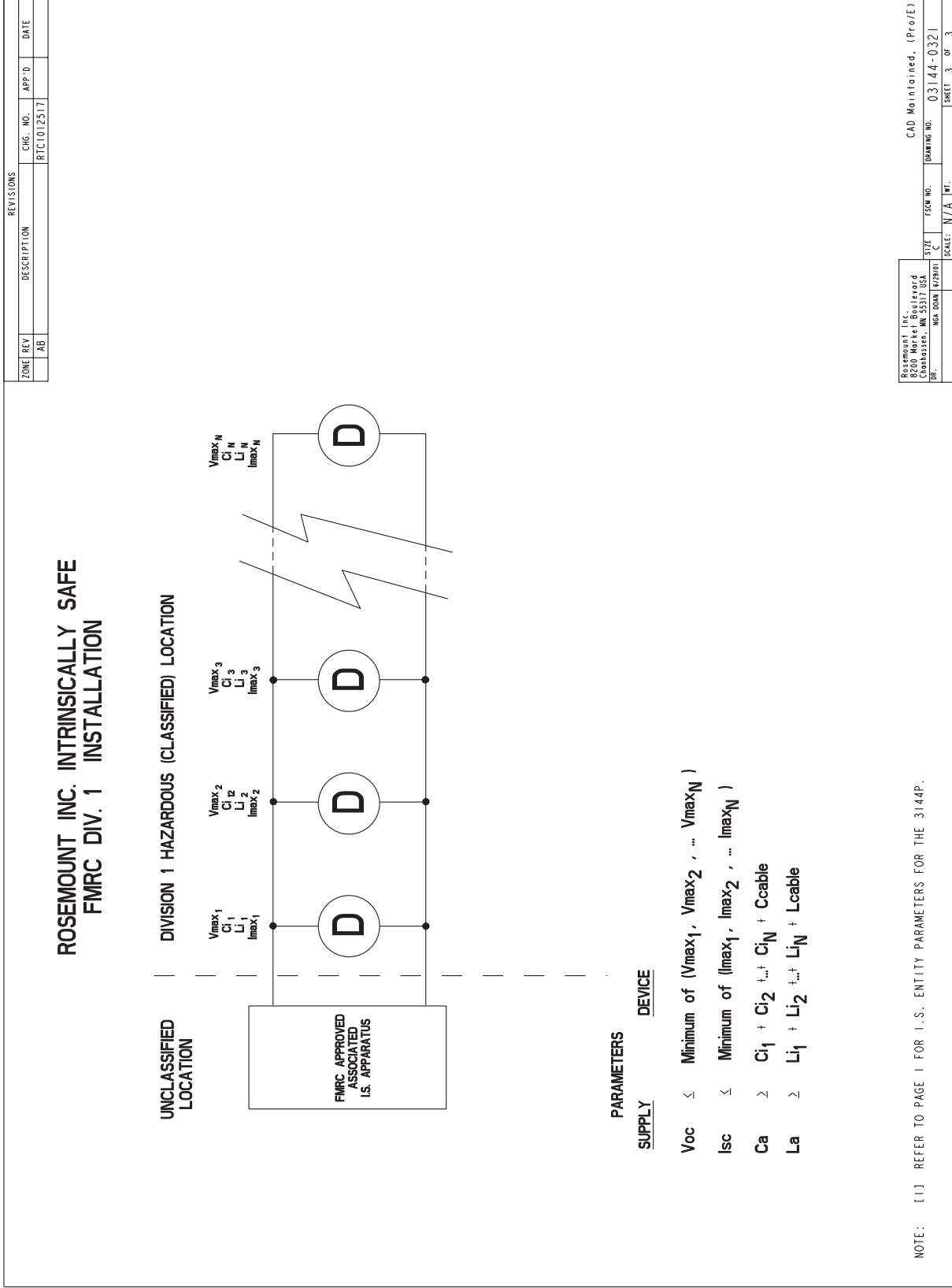

REVISIONS			
ZONE	REV	DESCRIPTION	DATE
	AB		

CHG. NO.	APP'D
RTCI012517	

Rosemount Inc. 8200 Market Boulevard Chanhassen, MN 55317 USA		CAD Maintained, (Pro/E)	
DR: NGA DOAN 6/27/04	SIZE: C	DRAWING NO: 03144-0321	SHEET 3 OF 3
SCALE: N/A		WT:	

3144\_3144-0321A04A

Figure B-3. FM 3144 Fieldbus Intrinsic Safety / FISCO Installation Drawing 03144-5075, Rev AB. Sheet 1 of 4.

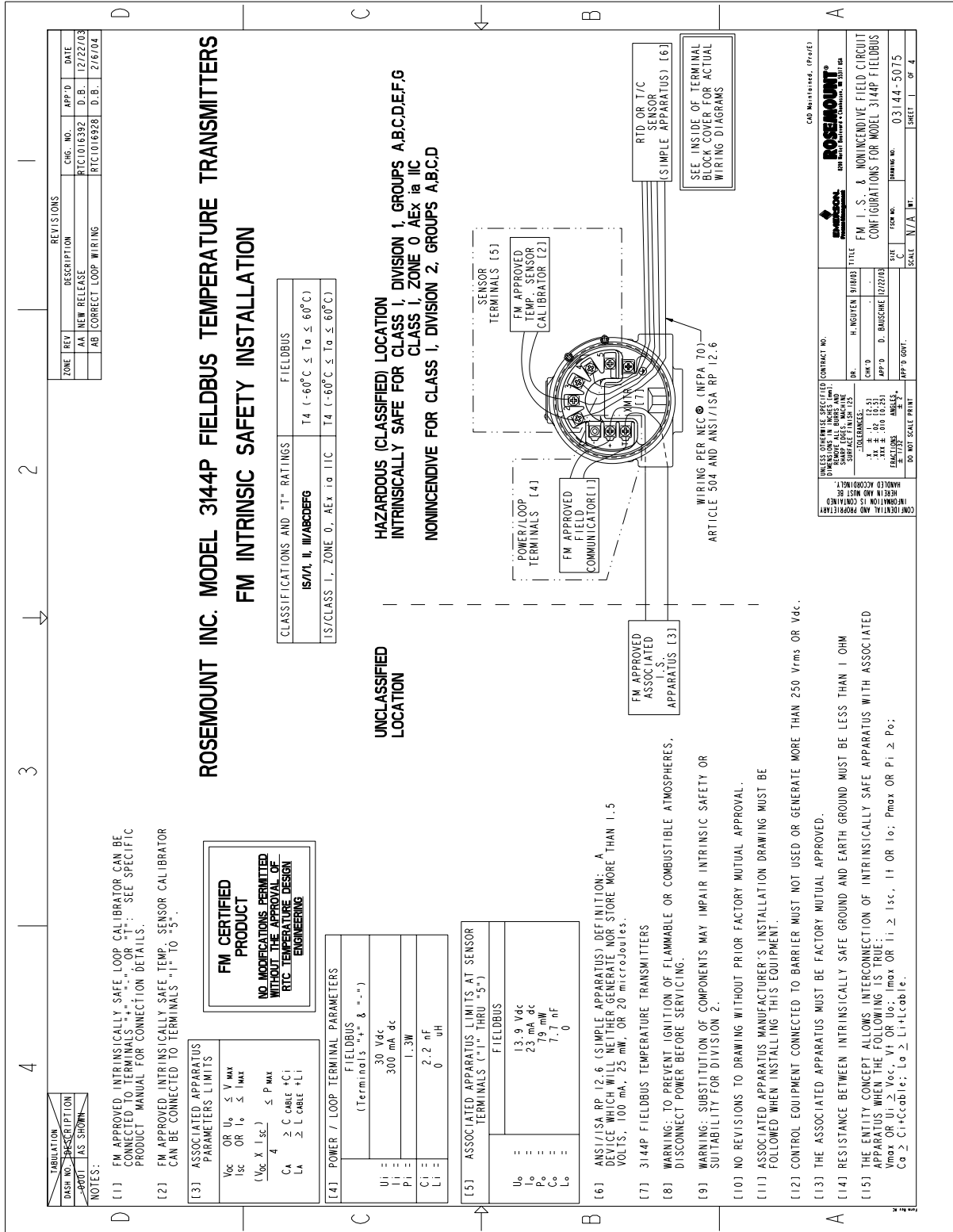





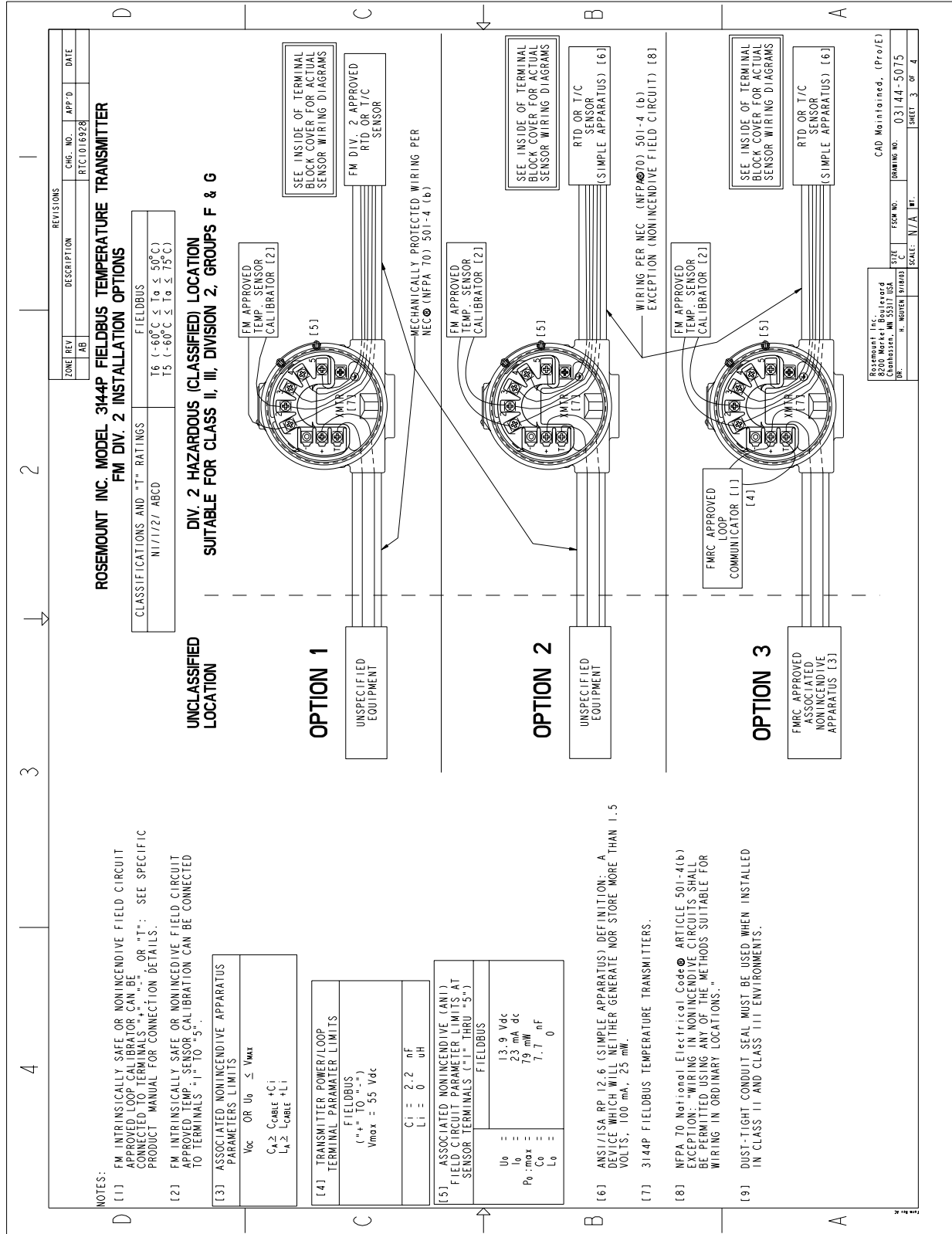

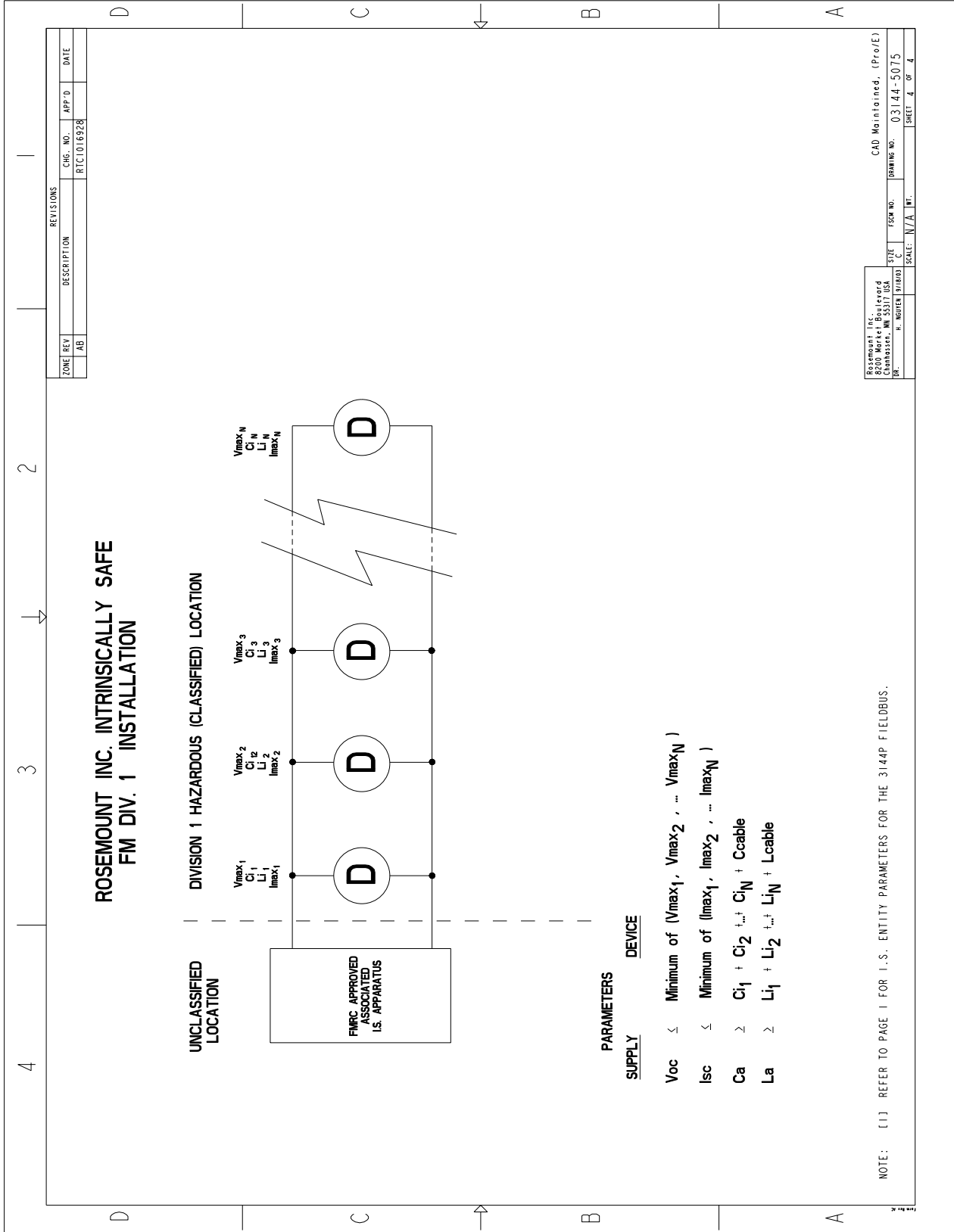

REVISIONS		CHG. NO.	APP'D	DATE
ZONE	REV	DESCRIPTION		
AB		RTCI 016928		

ROSEMOUNT INC. 8200 Market Boulevard Chanhassen, MN 55317 USA DPL	SIZE C	FSW NO. N/A	DRAWING NO. 03144-5075	CAD Maintained. (Prof/E)
H. NORTON 9/18/03	SCALE N/A		SHEET 4 OF 4	

Figure B-4. CSA Intrinsic Safety Approval Configuration Installation Drawing 03144-0322, Rev. AA

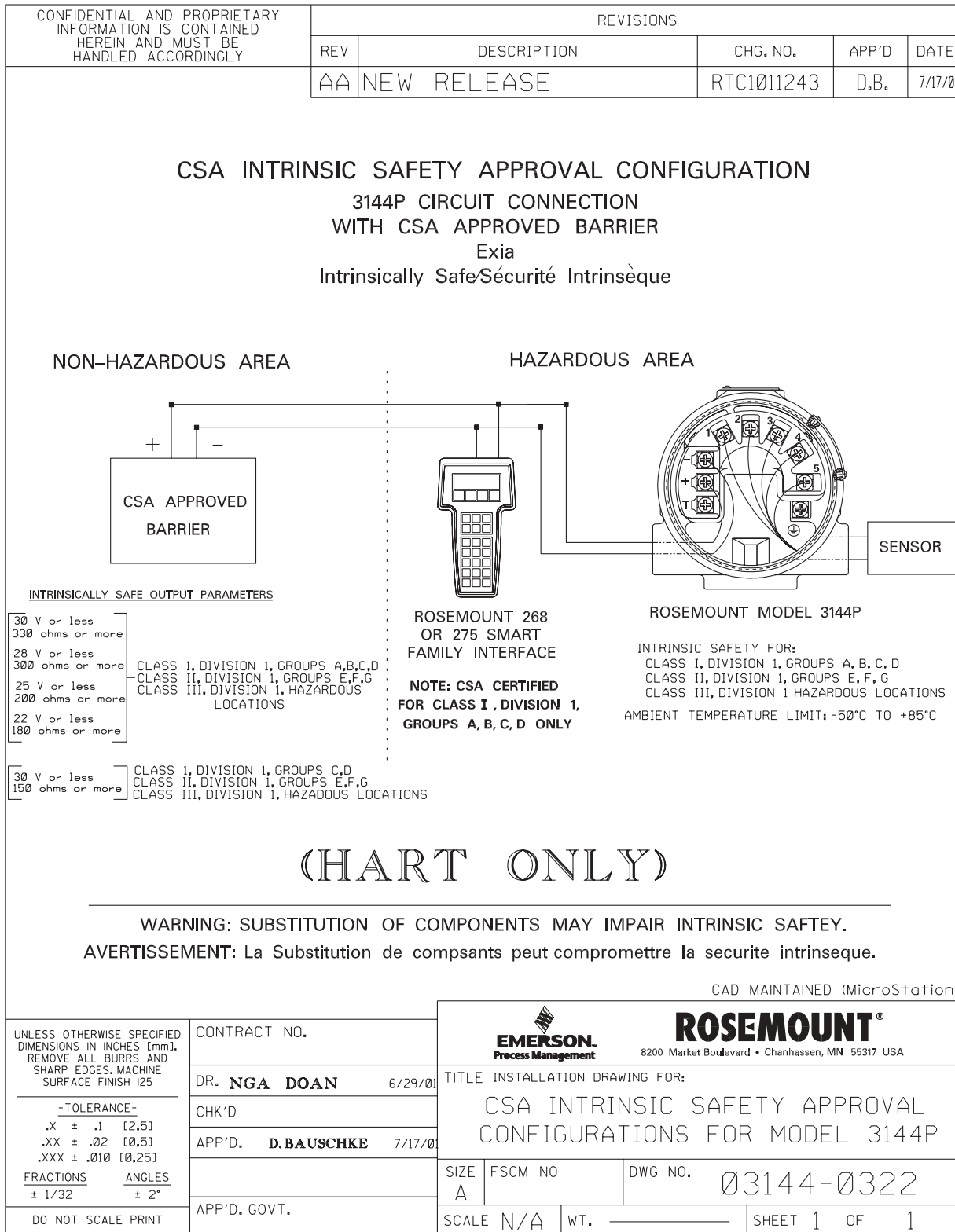

3144\_3144-0322A01A

Figure B-5. CSA 3144 Fieldbus Intrinsic Safety / FISCO Installation Drawing 03144-5076, Rev AA. Sheet 1 of 3.

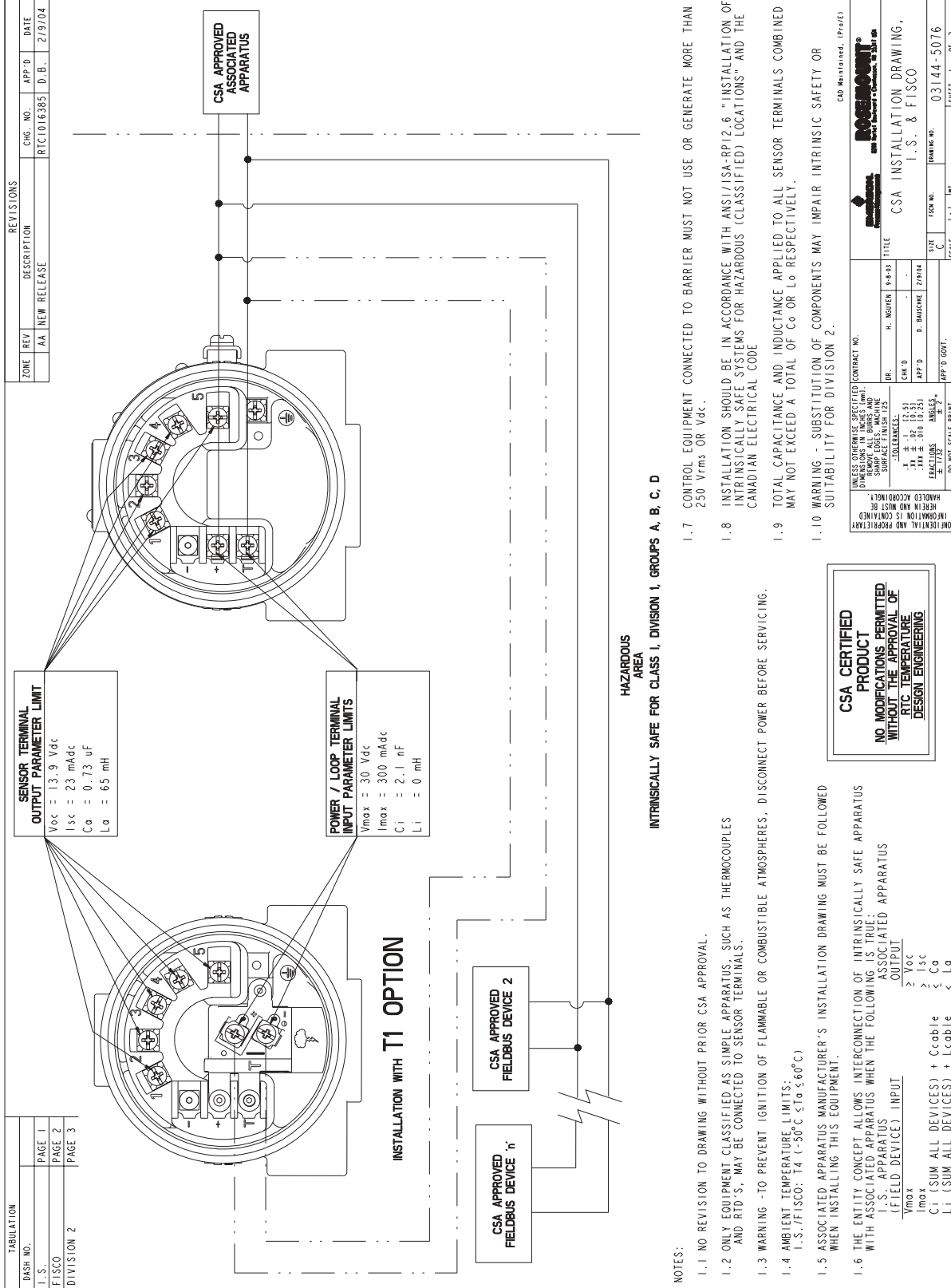

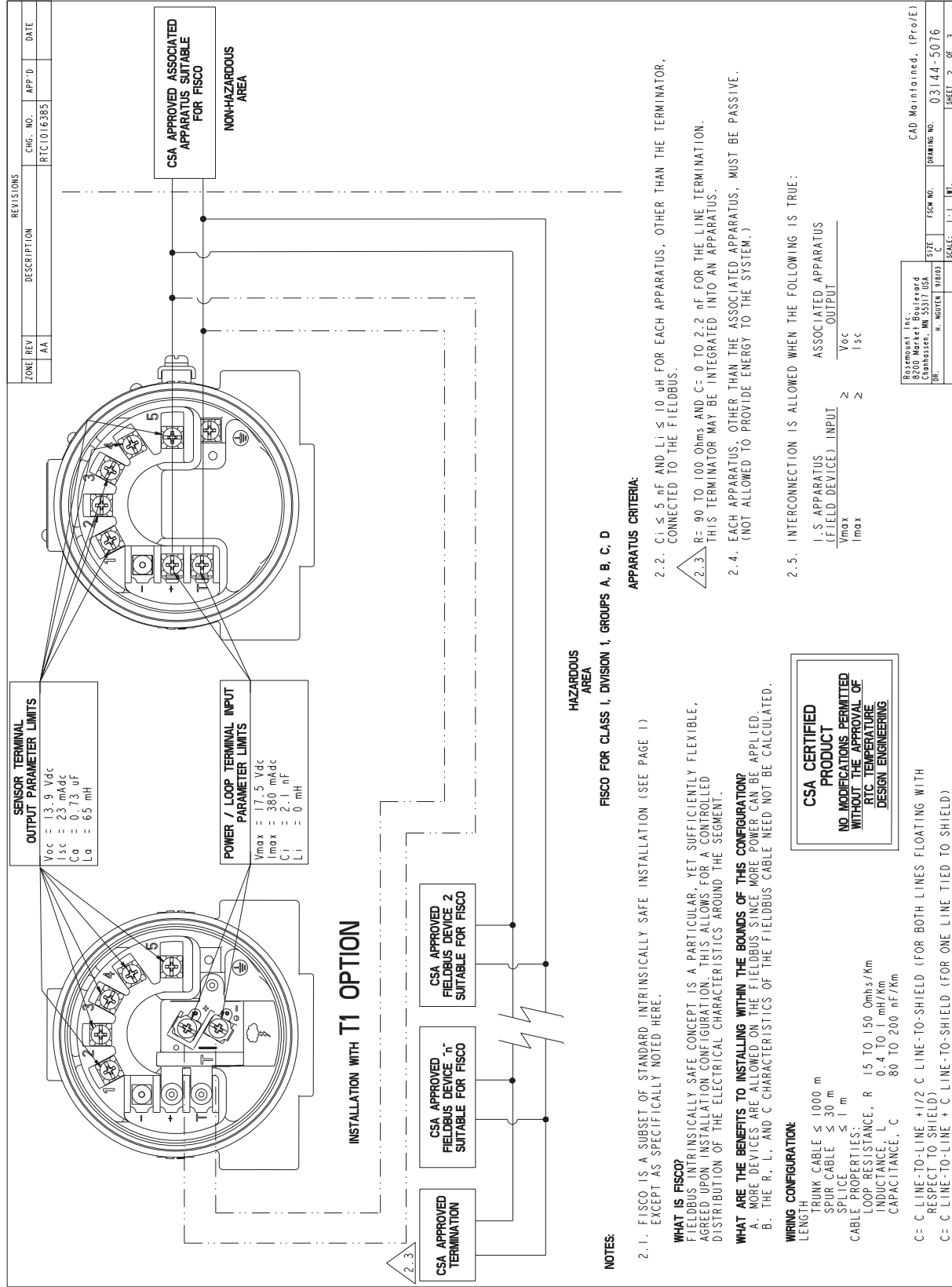

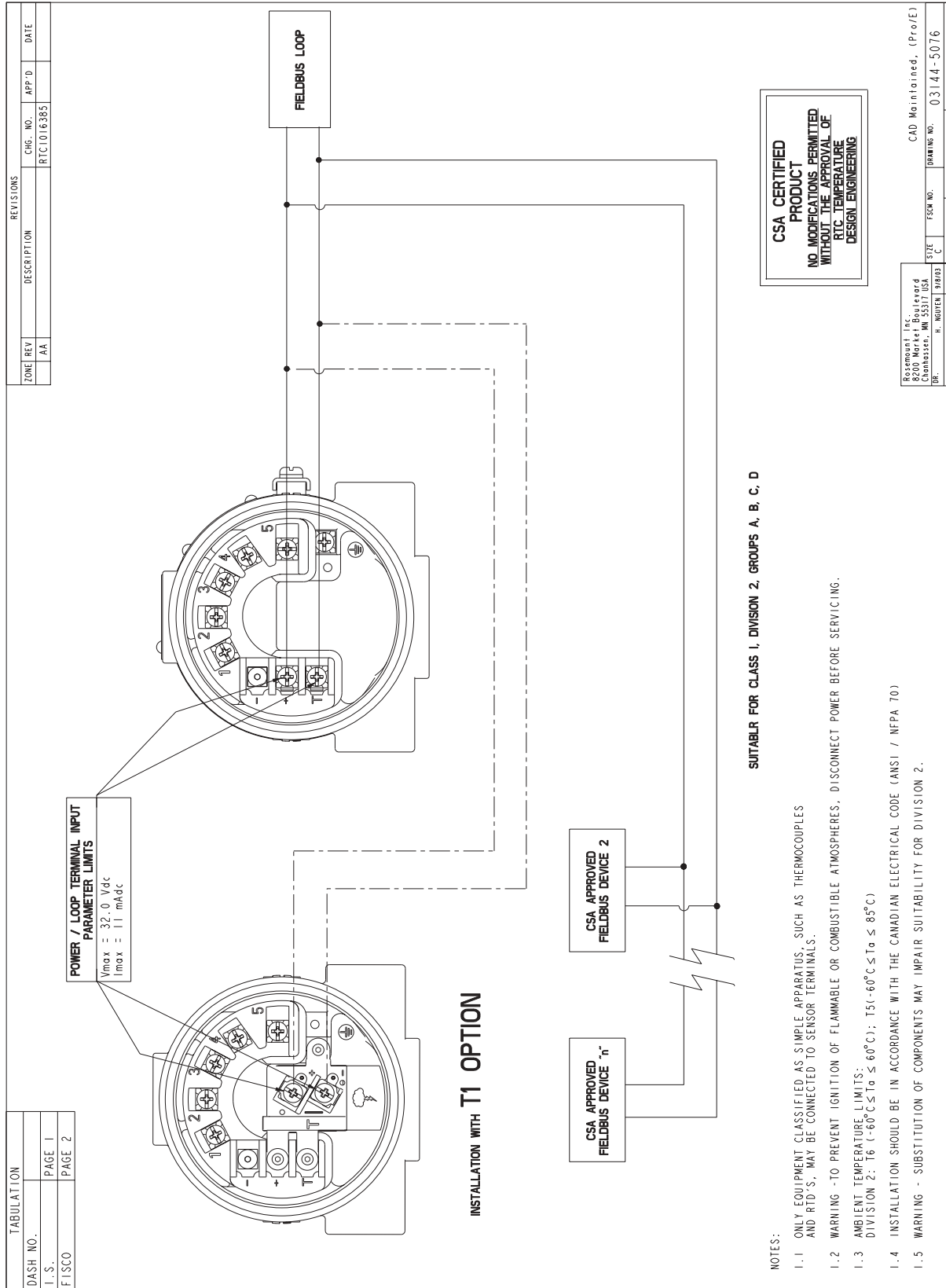
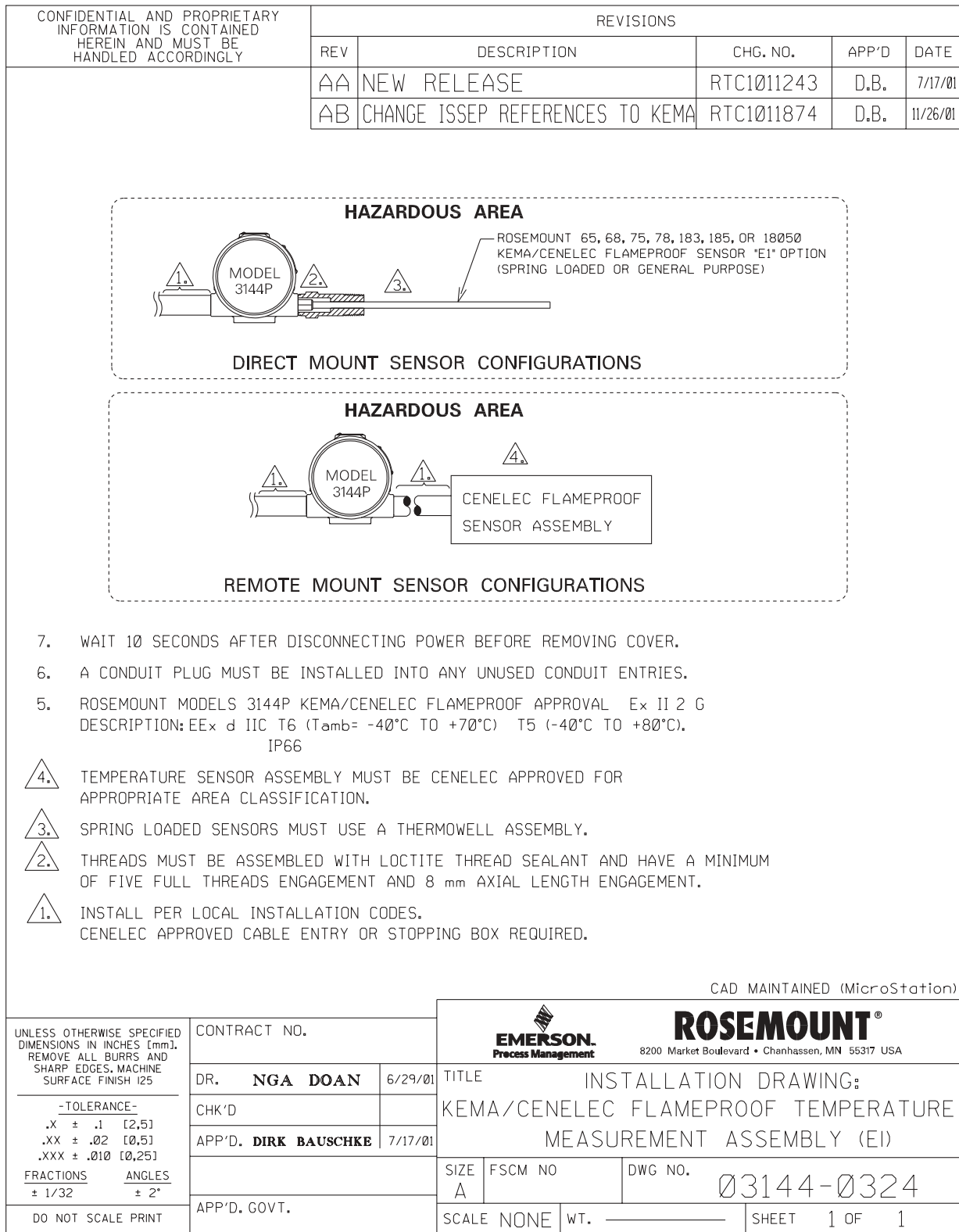

Figure B-6. ISSEP\CENELEC Flame-Proof Temperature Measurement Assembly Installation Drawing 03144-0324, Rev. AA



3144\_3144-0324A02A



Figure B-7. Standard Australia Quality Assurance Services Flameproof Temperature Measurement Assembly Installation Drawing 03144-0325, Rev. AA

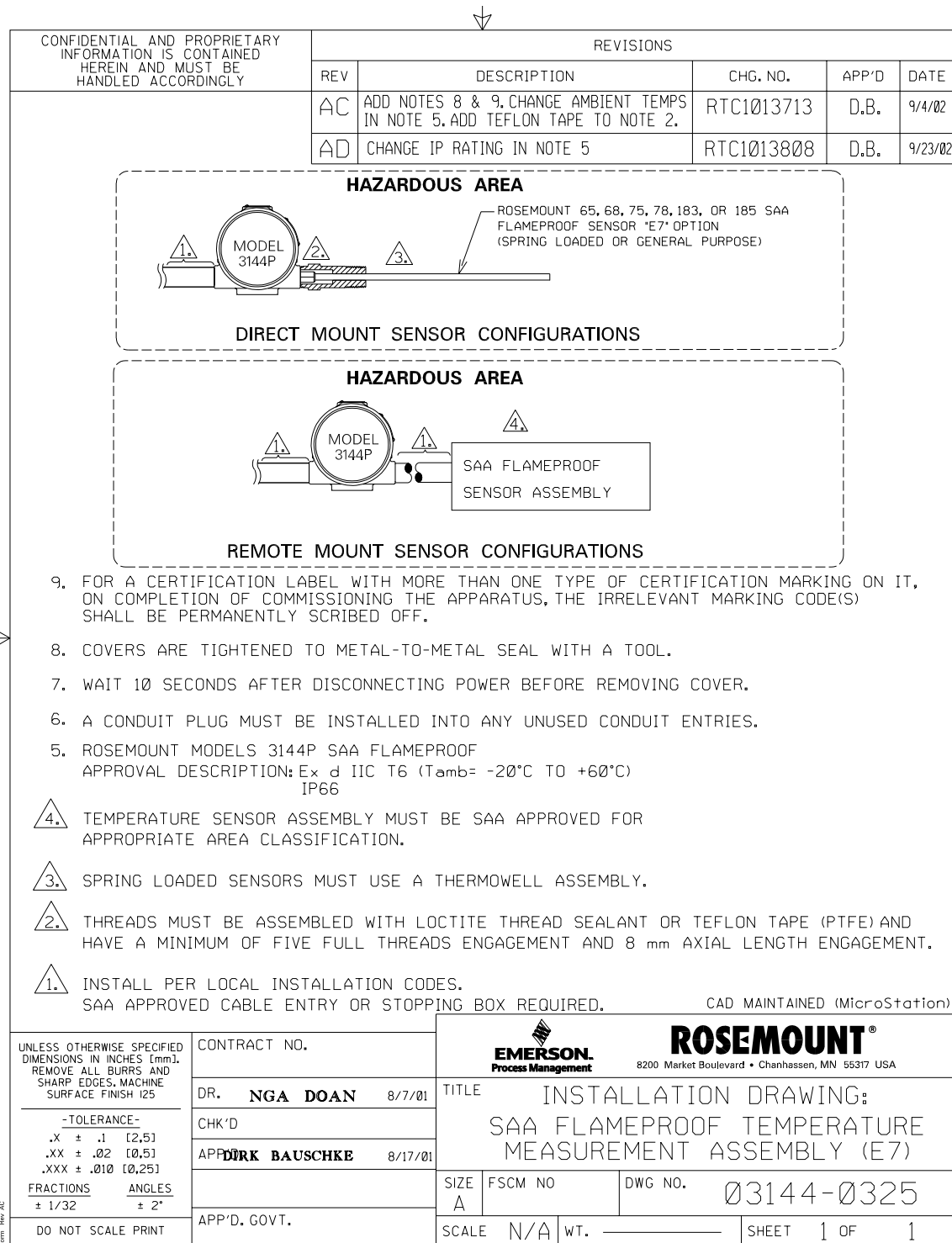

Form: Rev: AC

3144\_3144-0325A01A

# Rosemount 3144P

---

**Reference Manual**  
00809-0100-4021, Rev DA  
November 2004



*Rosemount, the Rosemount logotype, and Hot Backup are registered trademarks of Rosemount Inc.  
HART is a registered trademark of the HART Communication Foundation.  
Teflon is a registered trademark of E.I. du Pont de Nemours & Co.  
All other marks are the property of their respective owners.*

**Emerson Process Management**

**Rosemount Inc.**

8200 Market Boulevard  
Chanhassen, MN 55317 USA  
T (U.S.) 1-800-999-9307  
T (International) (952) 906-8888  
F (952) 949-7001

[www.rosemount.com](http://www.rosemount.com)



**Rosemount Temperature GmbH**

Frankenstrasse 21  
63791 Karlstein  
Germany  
T 49 (6188) 992 0  
F 49 (6188) 992 112

**Emerson Process Management Asia**

**Pacific Private Limited**  
1 Pandan Crescent  
Singapore 128461  
T (665) 777 8211  
F (665) 777 0947  
[AP.RMT-Specialist@emersonprocess.com](mailto:AP.RMT-Specialist@emersonprocess.com)