

Instruction manual

O₂ Transmitter 4100 e/2(X)H

METTLER TOLEDO



69951

Warranty

Defects occurring within 1 year from delivery date shall be remedied free of charge at our plant (carriage and insurance paid by sender).

Subject to change without notice.

Return of products under warranty

Please contact METTLER TOLEDO's Customer Service Dept. before returning a defective device. Ship the cleaned device to the address you have been given. If the device has been in contact with process fluids, it must be decontaminated/disinfected before shipment. In that case, please attach a corresponding certificate, for the health and safety of our service personnel.



Disposal (Directive 2002/96/EC of January 27, 2003)

Please observe the applicable local or national regulations concerning the disposal of "waste electrical and electronic equipment".



Mettler-Toledo GmbH, Process Analytics, Industrie Nord,
CH-8902 Urdorf, Tel. +41 (01) 736 22 11 Fax +41 (01) 736 26 36
Subject to technical changes. Mettler-Toledo GmbH, 04/04.
Printed in Germany.

Safety information	5
Intended use	7
Trademarks	7
Certificates	8
EC Declaration of Conformity	8
Support of FDA 21 CFR Part 11	9
EC-Type-Examination Certificate	10
Overview of O₂ Transmitter 4100 e/2(X)H	13
Assembly	14
Package contents	14
Mounting plan	15
Pipe mounting, panel mounting	16
Installation and connection	18
Information on installation	18, 20
Division 2 wiring	18
Terminal assignment	19
Wiring examples	22
User interface, display	26
Operation: Keypad	28
Safety functions	29
Sensocheck, Sensoface sensor monitoring	29
GainCheck device self test	29
Automatic device self-test	29
Hold mode	30
Outputs	31
(Current output / loop current, HART communication, Alarm)	31
Passcodes (factory setting)	33
Configuration	34
Menu structure of configuration	35
Overview of configuration steps	36
Individual settings (for copy)	37

Contents

Current output	38
Temperature compensation	50
Correction	52
Calibration mode	54
Alarm settings	56
Passcodes according to FDA 21 CFR Part 11	58
Calibration	60
Calibration to percent saturation (SAT)	62
Calibration to concentration (Conc)	64
Calibration to volume concentration	66
Product calibration	68
Zero calibration	70
Temp probe adjustment	72
Measurement	72
Diagnostics functions	73
Display of output currents	73
Display of calibration data (Cal Info)	73
Sensor monitor	73
Display of last error message	73
Specify output current	74
Cleaning	74
Operating states	75
Error messages (error codes)	76
Calibration error messages	77
Sensoface	80
Sensochek	80
Appendix	83
Product line and accessories	83
Specifications	84
FM Control Drawing	90
Explosion protection	92
CSA Control Drawing	94
Index	97

Safety information

Be sure to read and observe the following instructions!

The device has been designed using state of the art technology and it complies with the applicable safety regulations.

When operating the device, certain conditions may nevertheless lead to danger for the operator or damage to the device.

Caution!

Commissioning may only be carried out by trained experts. Whenever it is likely that protection has been impaired, the device shall be made inoperative and secured against unintended operation.

The protection is likely to be impaired if, for example:

- the device shows visible damage
- the device fails to perform the intended measurements
- after prolonged storage at temperatures above 70 °C
- after severe transport stresses

Before recommissioning the device, a professional routine test in accordance with EN 61010-1 must be performed. This test should be carried out by the manufacturer.

Caution!

Before commissioning it must be proved that the device may be connected with other equipment.

Safety precautions for installation

- The stipulations of EN 60079-10 / EN 60079-14 must be observed during commissioning.
- The **O₂ Transmitter 4100 e/2H** is approved for measurements in FM Class I Div 2.
- The **O₂ Transmitter 4100 e/2XH** is approved for operation in the following locations: ATEX, FM Zone 1 with measurement in Zone 0, and FM Class I Div 1.

Connection to supply units

- **O₂ Transmitter 4100 e/2H**: Before connecting this device to a supply unit, make sure that its output voltage cannot exceed 30 V DC.
Do not use alternating current or mains power supply!
- **O₂ Transmitter 4100 e/2XH**: This device may only be connected to an explosion-proof power supply unit (for input ratings refer to annex of EC-Type-Examination Certificate).
Before commissioning it must be made sure that the connections to other equipment such as power supply unit and cables are intrinsically safe.

Terminals:

suitable for single wires / flexible leads up to 2.5 mm² (AWG 14)

Note for cleaning in a hazardous location

In hazardous locations the Transmitter may only be cleaned with a damp cloth to prevent electrostatic discharge.

Intended use

The O₂ Transmitter 4100 e/2(X)H is used for measuring dissolved or gaseous oxygen and temperature in biotechnology, chemical and pharmaceutical industry, as well as in the field of industry, environment, food processing, and sewage treatment.

The rugged molded enclosure can be wall or pipe mounted or fixed into a control panel.

The protective hood provides additional protection against direct weather exposure and mechanical damage.

The Transmitter has been designed for application with amperometric METTLER TOLEDO sensors of the **InPro 6800** and InPro 6900 series.

- The **O₂ Transmitter 4100 e/2H** is approved for measurements in FM Class I Div 2.
- The **O₂ Transmitter 4100 e/2XH** is approved for operation in the following locations: ATEX, FM Zone 1 with measurement in Zone 0, and FM Class I Div 1.

Trademarks

The following names are registered trademarks. For practical reasons they are shown without trademark symbol in this manual.

Calimatic

GainCheck

Sensocheck

Sensoface

InPro® is a registered trademark of Mettler-Toledo.

HART® is a registered trademark of the HART Communications Foundation (HCF).

EC Declaration of Conformity

Mettler-Toledo GmbH

Process Analytics

Adresse Im Hackacker 15 (Industrie Nord), CH-8902 Urdorf, Schweiz
Briefadresse Postfach, CH-8902 Urdorf
Telefon 01-735 22 11
Telefax 01-735 26 36
Internet www.mt.com
Bank Credit Suisse First Boston, Zürich (Acc. 0835-370601-21-90)

Declaration of conformity Konformitätserklärung Déclaration de conformité



We/Wir/Nous

Mettler-Toledo GmbH, Process Analytics

Im Hackacker 15
8902 Urdorf
Switzerland

declare under our sole responsibility that the product,
erklären in alleiniger Verantwortung, dass dieses Produkt,
déclarons sous notre seule responsabilité que le produit,

Description

Beschreibung/Description

0₁-4100/2(X)H

to which this declaration relates is in conformity with the following standard(s) or
other normative document(s).

auf welches sich diese Erklärung bezieht, mit der/den folgenden Norm(en) oder
Richtlinie(n) übereinstimmt.

auquel se réfère cette déclaration est conforme à la (aux) norme(s) ou au(x)
document(s) normatif(s).

Explosionsschutzrichtlinie

Explosion Protection / Pro- tection contre les explosions

94/9/EG

EMC Directive/EMV-Richtlinie

Directive concernant la CEM

89/336/EGW

SR 734.5, VEMV

Low-voltage directive/Nieder- spannungs-Richtlinie/

Directive basse tension

73/23/EGW

SR 734.26, NEV

Norm/Standard/Standard

EN 50 014:

1997

EN 50 020:

1994

EN 61326

/ VDE 0843 Teil 20:

2002-03

EN 61010 Teil

/ VDE 0411 Teil 1:

2002-08

Place and Date of issue

Ausstellungsort / - Datum

Lieu et date d'émission

Urdorf, March 15, 2004

Mettler-Toledo GmbH, Process Analytics

Waldemar Rauch
General Manager PO Urdorf

Artikel Nr.: 52960316 KE

Christian Zwicky
Head of Marketing

Dateiname: 52960316KE-4100e-2(X)H-inte

METTLER TOLEDO

Sitz der Gesellschaft Mettler-Toledo GmbH, Im Langacher, CH-8606 Greifensee

Support of FDA 21 CFR Part 11

In their directive “Title 21 Code of Federal Regulations, 21 CFR Part 11, Electronic Records; Electronic Signatures” the US American health agency FDA (Food and Drug Administration) regulates the production and processing of electronic documents for pharmaceutical development and production. This results in requirements for measuring devices used for corresponding applications. The following features ensure that the measuring devices of the O₂ Transmitter 4100 e Series meet the demands of FDA 21 CFR Part 11:

Electronic Signature

Access to the device functions is regulated and limited by individually adjustable codes – “Passcodes” (for Passcode Editor see Page 58, overview of factory settings on back of manual). This prevents unauthorized modification of device settings or manipulation of the measurement results. Appropriate use of these passcodes makes them suitable as electronic signature.

Audit Trail

Every (manual) change of device settings can be automatically documented. For that purpose, each change is marked by a “Configuration Change Flag”, which can be interrogated and documented via HART communication. Then the changed device settings/parameters can also be retrieved and documented via HART communication.

EC-Type-Examination Certificate



Translation

EC-TYPE EXAMINATION CERTIFICATE

- (1) Equipment and protective systems intended for use in potentially explosive atmospheres - **Directive 94/9/EC**
- (3) EC-Type Examination Certificate Number



TÜV 04 ATEX 2431

- (4) Equipment: Transducer type O₂ 4100/2XH
- (5) Manufacturer: Mettler Toledo GmbH
Process Analytics
- (6) Address: CH-8902 Urdorf, Im Hackacker 15
- (7) This equipment or protective system and any acceptable variation thereto are specified in the schedule to this certificate and the documents therein referred to.
- (8) The TÜV NORD CERT GmbH & Co. KG, TÜV CERT-Certification Body, notified body number N° 0032 in accordance with Article 9 of the Council Directive of the EC of March 23, 1994 (94/9/EC), certifies that this equipment or protective system has been found to comply with the Essential Health and Safety Requirements relating to the design and construction of equipment and protective systems intended for use in potentially explosive atmospheres given in Annex II to the Directive.

The examination and test results are recorded in the confidential report N° 04 YEX 551230.

- (9) Compliance with the Essential Health and Safety Requirements has been assured by compliance with:
EN 50014:1997 EN 50020:2002 EN 50284:1999
- (10) If the sign "X" is placed after the certificate number, it indicates that the equipment or protective system is subject to special conditions for safe use specified in the schedule to this certificate.
- (11) This EC-type examination certificate relates only to the design, examination and tests of the specified equipment in accordance to the Directive 94/9/EC. Further requirements of the Directive apply to the manufacturing process and supply of this equipment. These are not covered by this certificate.
- (12) The marking of the equipment or protective system must include the following:



II 2 (1) G EEx ib [ia] IIC T6

TÜV NORD CERT GmbH & Co. KG
TÜV CERT-Certification Body
Am TÜV 1
D-30519 Hannover
Tel.: 0511 986-1470
Fax: 0511 986-2555

Head of the
Certification Body



Hanover, 2004-02-09



(13)

SCHEDULE(14) **EC-TYPE EXAMINATION CERTIFICATE N° TÜV 04 ATEX 2431**

(15) Description of equipment

The transducer type O₂ 4100/2XH is preferable intended for the detection and processing of electrochemical parameters of fluids. For this purpose the transducer is equipped with one input for the oxygen measurement and one for temperature measurement.

The maximum permissible ambient temperature is 55°C.

Electrical data

Loop measuring circuit
(KL 10, 11)

in type of protection Intrinsic Safety EEx ib IIC
only for the connection of certified intrinsically safe circuit with
the following maximum values:

$$U_i = 30 \text{ V}$$

$$I_i = 100 \text{ mA}$$

$$P_i = 0,8 \text{ W}$$

$$\text{effective internal capacitance } C_i = 20 \text{ nF}$$

$$\text{effective internal inductance } L_i = 0,2 \text{ mH}$$

Oxygen measuring circuit
(KL 1, 2, 4, 5, 6)

in type of protection Intrinsic Safety EEx ia IIC
Maximum values:

$$U_o = 10 \text{ V}$$

$$I_o = 10 \text{ mA}$$

$$P_o = 13 \text{ mW}$$

Characteristic line: linear

$$\text{effective internal capacitance } C_i = 15 \text{ nF}$$

The internal inductance is negligibly small.

$$\text{max. permissible outer capacitance } C_o = 1,5 \text{ } \mu\text{F}$$

$$\text{max. permissible outer inductance } L_o = 1,0 \text{ mH}$$

Temperature measuring circuit
(KL 7, 8)

in type of protection Intrinsic Safety EEx ia IIC
Maximum values:

$$U_o = 5 \text{ V}$$

$$I_o = 1 \text{ mA}$$

$$P_o = 2 \text{ mW}$$

Characteristic line: linear

$$\text{effective internal capacitance } C_i = 120 \text{ nF}$$

The internal inductance is negligibly small.

$$\text{max. permissible outer capacitance } C_o = 1,38 \text{ } \mu\text{F}$$

$$\text{max. permissible outer inductance } L_o = 1,0 \text{ mH}$$

Oxygene/temperature measuring circuit
(Circuits interconnected)
(KL 1, 2, 4, 5, 6, 7, 8)

in type of protection Intrinsic Safety EEx ia IIC
Maximum values:

$$U_o = 10 \text{ V}$$

$$I_o = 11 \text{ mA}$$

$$P_o = 14 \text{ mW}$$



characteristic line: linear
effective internal capacitance $C_i = 135 \text{ nF}$
The internal inductance is negligibly small.
max. permissible outer capacitance $C_o = 1,38 \text{ }\mu\text{F}$
max. permissible outer inductance $L_o = 1,0 \text{ mH}$

or

for the connection of the oxygen sensors type InPro
6XXX/**/**/** according to SNCH 01 ATEX 3277 X

PA
(KL 9)

for the connection to the equipotential bonding system

The loop measuring circuit is safely galvanically separated from all other measuring circuits up to a voltage of 60 V. The oxygen measuring circuit and the temperature measuring circuit are galvanically connected.

(16) Test documents are listed in the test report No.: 04 YEX 551230.

(17) Special conditions for safe use

none

(18) Essential Health and Safety Requirements

no additional ones

Overview of the O₂ Transmitter 4100 e/2(X)H

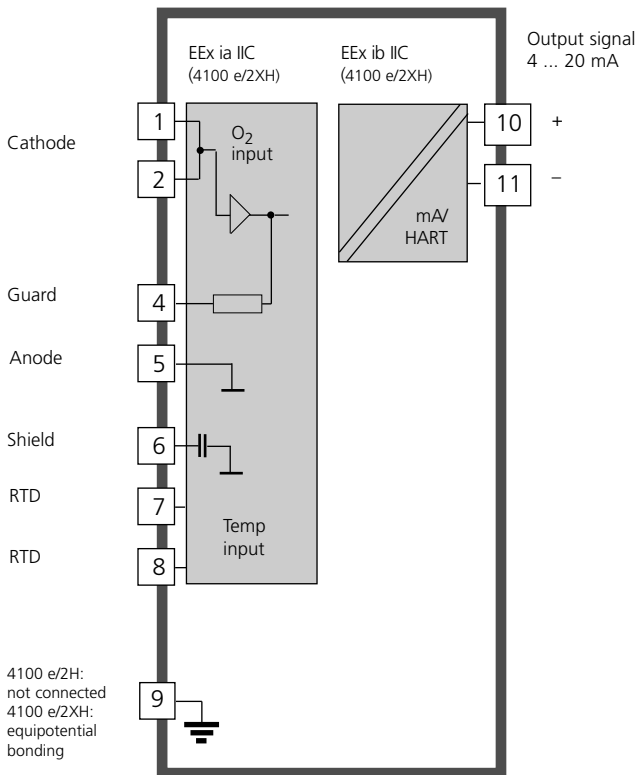

Assembly

Package contents

Check the shipment for transport damage and completeness.
The package should contain:

- Front unit
- Lower case
- Bag containing small parts
- Instruction manual
- Specific test report

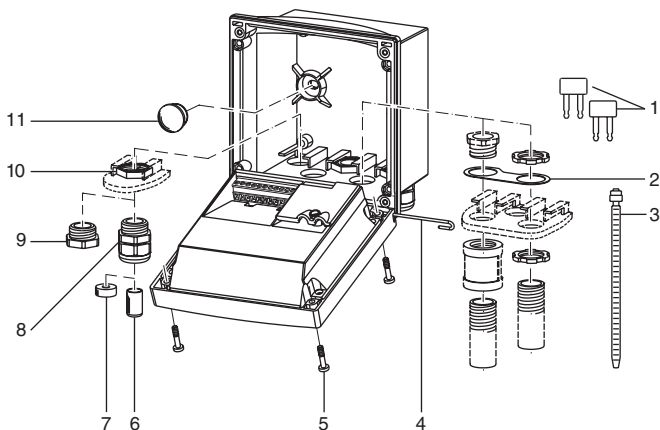

- | | |
|--|--|
| 1 Jumper (2 piece) | 6 Sealing inserts (1 piece) |
| 2 Washer (1 piece), for conduit mounting: place washer between enclosure and nut | 7 Rubber reducer (1 piece) |
| 3 Cable ties (3 pieces) | 8 Cable glands (3 pieces) |
| 4 Hinge pin (1 piece), insertable from either side | 9 Filler plugs (3 pieces) |
| 5 Enclosure screws (4 pieces) | 10 Hexagon nuts (5 pieces) |
| | 11 Sealing plugs (2 pieces):
for sealing in case of wall mounting |

Fig.: Assembling the enclosure

Mounting plan

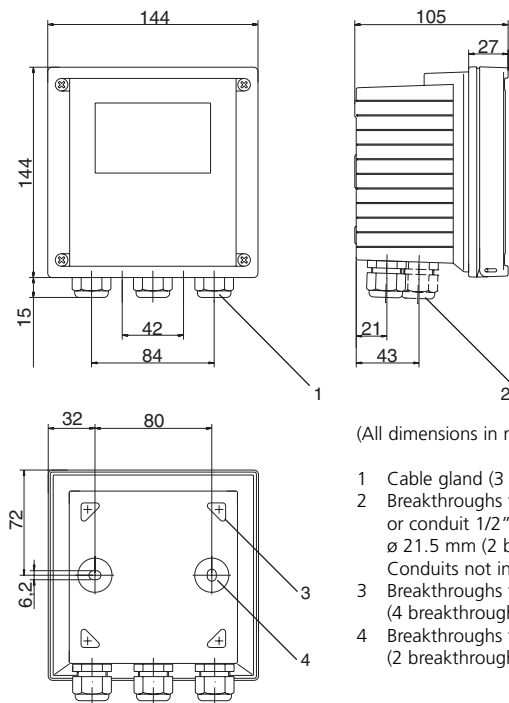
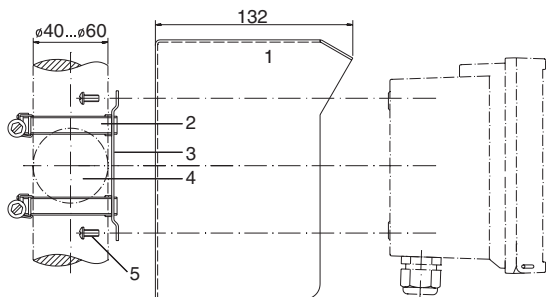

Fig.: Mounting plan

Pipe mounting, panel mounting



- 1 Protective hood (if required)
- 2 Hose clamps with worm gear drive to DIN 3017 (2 pieces)
- 3 Pipe-mount plate (1 piece)
- 4 For vertical or horizontal posts or pipes
- 5 Self-tapping screws (4 pieces)

(All dimensions in mm.)

Fig.: Pipe-mount kit

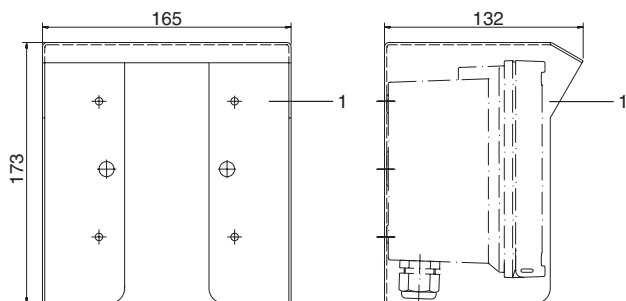
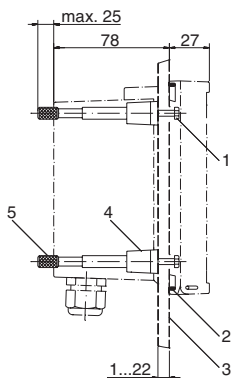

Fig.: Protective hood for wall and pipe mounting



(All dimensions in mm.)

- 1 Screws (4 pieces)
- 2 Gasket (1 piece)
- 3 Panel
- 4 Span pieces (4 pieces)
- 5 Threaded sleeves (4 pieces)

Panel cutout 138 x 138 mm
(DIN 43700)

Fig.: Panel-mount kit

Installation and connection

Information on installation

- Installation may only be carried out by trained experts in accordance with this instruction manual and as per applicable local and national codes.
- Be sure to observe the technical specifications and input ratings.
- Be sure not to notch the conductor when stripping the insulation.
- When commissioning, a complete configuration must be carried out by the system administrator.

Connection to supply units

- **O₂ Transmitter 4100 e/2H:** Before connecting this device to a supply unit, make sure that its output voltage cannot exceed 30 V DC. Do not use alternating current or mains power supply!
- **O₂ Transmitter 4100 e/2XH:** This device may only be connected to an explosion-proof power supply unit (for input ratings refer to annex of EC-Type-Examination Certificate).

Terminals:

suitable for single wires / flexible leads up to 2.5 mm² (AWG 14)

Warning!

Additional safety precautions have to be taken for applications in hazardous locations to CSA!

(See Pg 93 et seq.)

Division 2 wiring



The connections to the Transmitter must be installed in accordance with the National Electric Code (ANSI-NFPA 70) Division 2 hazardous (classified) location non-incendive wiring techniques.

FM Control Drawing: Refer to page 90.

Terminal assignments





 NI, CLI, DIV2, GRP A, B, C, D, T4, Type 2 HAZARDOUS LOCATION per Control Drawing 194.401-120	 <p>Terminal assignments: 11 (+), 10 (-), 9 (do not connect), 8 (RTD), 7 (RTD), 6 (shield), 5 (anode), 4 (guard), 2 (cathode), 1 (cathode). Input: 8, 7, 6, 5, 4 Output: 11, 10 Current: 4 to 20 mA</p>	 shield observe grounding conditions 	 CE 0499 000000/00000000 000000

Fig.: Terminal assignments O₂ Transmitter 4100 e/2H



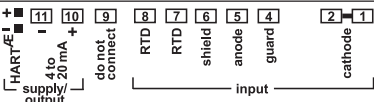



 TÜV 04 ATEX 2431 II2 (1) G EEx ib [ia] IIC T6 Electrical data see EC-Type Examination Certificate CH-8902 Urdorf Switzerland	 IS, CLI, DIV1, GRP A, B, C, D T4 Ex ib [ia] IIC T4 CLI, DIV2, GRP A, B, C, D T4 Ex nAL [L] IIC CSA 2005.1662790	 <p>Terminal assignments: 11 (+), 10 (-), 9 (do not connect), 8 (RTD), 7 (RTD), 6 (shield), 5 (anode), 4 (guard), 2 (cathode), 1 (cathode). Input: 8, 7, 6, 5, 4 Output: 11, 10 Current: 4 to 20 mA</p>	 shield observe grounding conditions 	 CE 0499 000000/00000000 000000

Fig.: Terminal assignments O₂ Transmitter 4100 e/2XH

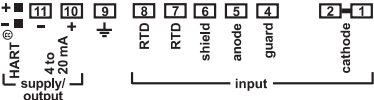

1 Recommended stripping lengths for multi-core cables

2 Pulling out the terminals using a screwdriver (also see **6**)

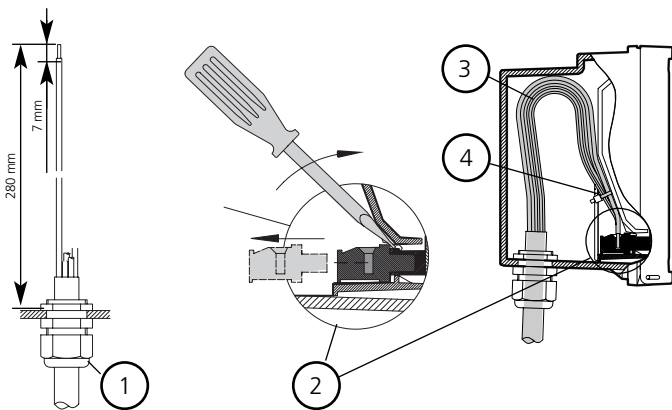
3 Cable laying in the device

4 Connecting lines for current supply

5 Cover for sensor and temperature probe terminals

6 Area for placing the screwdriver to pull out the terminals

7 Connection of current supply and HART handheld terminal

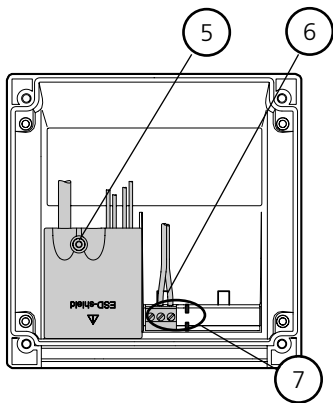
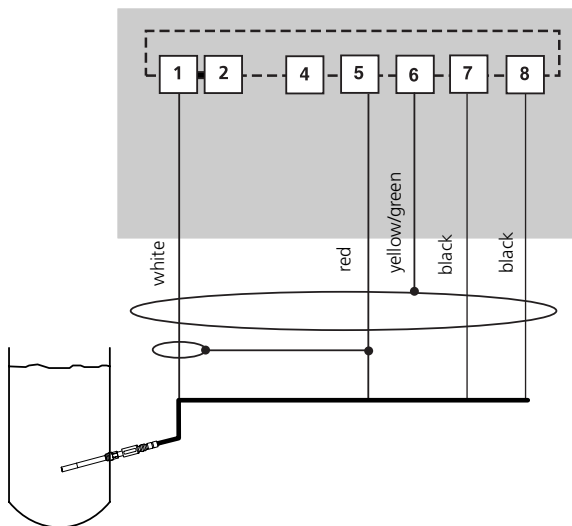

Fig.: Information on installation, rear side of device

Wiring example 1

Sensors with connection via T82



Connection	Terminal	InPro6800 sensor
cathode	1	white (coax core)
	2	not connected
guard	4	not connected
	5	red (coax shield)
anode	6	yellow/green (external shield)
shield	7	black
RTD	8	black
RTD		

Wiring example 2

METTLER TOLEDO

Sensors with connection via VP cable

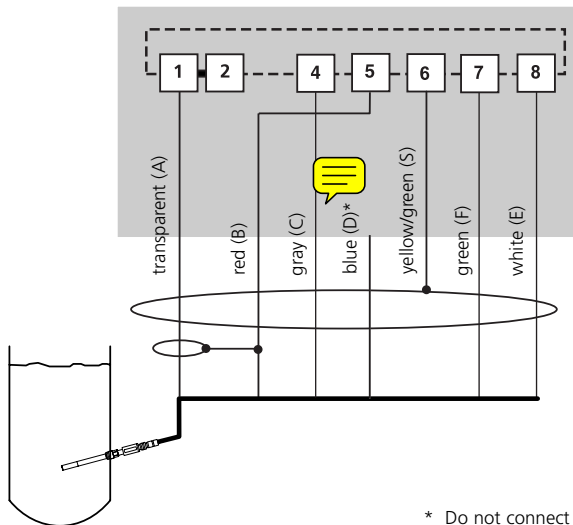

Connection	Terminal	InPro6800/6900 sensor VP cable
cathode	1	transparent (coax core)
	2	not connected
guard	4	gray (InPro6900)
anode	5	red (coax shield)
shield	6	yellow/green (external shield)
RTD	7	green
RTD	8	white

Wiring example 2

Connecting sensor and VP cable

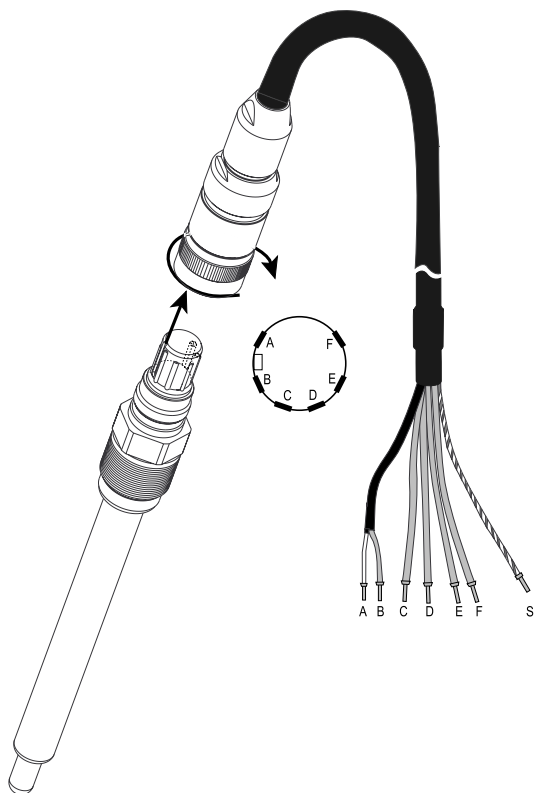

VP cable connector assignment

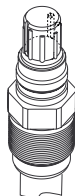

A transparent

Cathode

B red

Anode

C gray

Guard

D blue

Not connected

E white

RTD

F green

RTD

S green/yellow

Outer shield

$C = 220 \text{ nF}$

RTD = temperature probe

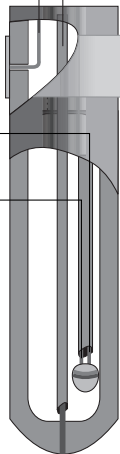

User interface and display

User interface

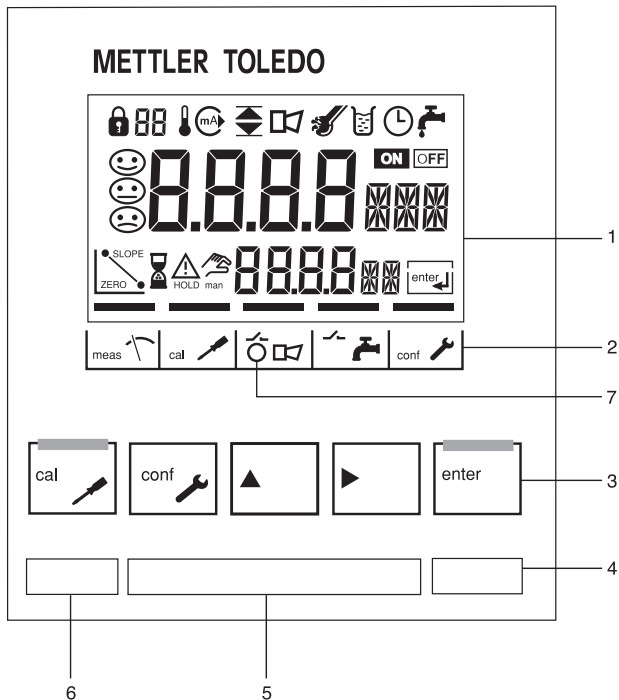

- 1 Display
- 2 Mode indicators (no keys), from left to right:
 - Measuring mode
 - Calibration mode
 - Alarm
 - Wash contact (Model O₂ 4100 e only)
 - Configuration mode
- 3 Keypad
- 4 Coding
- 5 Rating plate
- 6 Model designation
- 7 Alarm LED



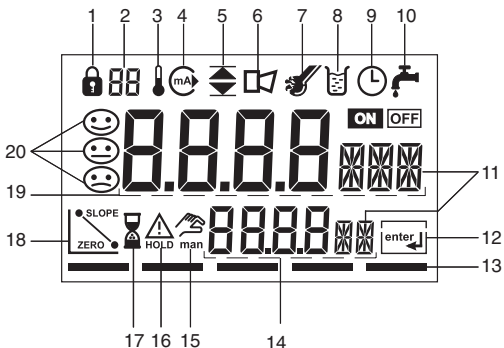







Display



- | | |
|---|--------------------------|
| 1 Passcode entry | 14 Lower display |
| 2 Display of measured variable* | 15 Manual temp indicator |
| 3 Temperature | 16 Hold mode active |
| 4 Current output | 17 Waiting time running |
| 5 Limit values | 18 Sensor data |
| 6 Alarm | 19 Main display |
| 7 Sensocheck | 20 Sensoface |
| 8 Calibration | |
| 9 Interval/response time | |
| 10 Wash contact | |
| 11 Measurement symbols | |
| 12 Proceed with enter | |
| 13 Bar for identifying the device status, above mode indicators from left to right: | |
| - Measuring mode | |
| - Calibration mode | |
| - Alarm | |
| - Wash contact* | |
| - Configuration mode | |

* Not in use

Operation: Keypad

	Start, end calibration
	Start, end configuration
	Select digit position (selected position flashes)
	Edit digit
	<ul style="list-style-type: none">• Calibration: Continue in program sequence• Configuration: Confirm entries, next configuration step• Measuring mode: Display output current
 ➔ 	Cal Info, display of zero current and slope
 ➔ 	Error Info: Display of last error message
 + 	Start GainCheck device self-test

Safety functions

Sensocheck, Sensoface sensor monitoring

Sensocheck continuously monitors the sensor and lines. Sensocheck can be switched off (Configuration, Pg 57). With sensor type B Sensocheck must be switched off



Sensoface provides information on the sensor condition.





The slope, response time and Sensocheck during calibration are evaluated. The three Sensoface indicators provide the user with information about wear and required maintenance of the sensor.



GainCheck device self-test

A display test is carried out, the software version is displayed and the memory and measured value transfer are checked.

Start GainCheck device self-test:  + 

Automatic device self-test

The automatic device self-test checks the memory and measured-value transfer. It runs automatically in the background at fixed intervals.

Safety functions

Hold mode

Display: 

The Hold mode is a safety state during configuration and calibration. Output current is frozen (LAST) or set to a fixed value (FIX).

If the calibration or configuration mode is exited, the Transmitter remains in the Hold mode for safety reasons. This prevents undesirable reactions of the connected peripherals due to incorrect configuration or calibration. The measured value and "HOLD" are displayed alternately. The Transmitter only returns to measuring mode after **enter** is pressed and a waiting time of 20 s has passed.

Configuration mode is also exited automatically 20 minutes after the last keystroke (timeout). The Transmitter returns to measuring mode.

Timeout is not active during calibration.

Behavior of output signal:

LAST: The loop current is frozen at its last value.

The process should not change decisively during configuration/calibration. Changes are not noticed with this setting!

FIX: The loop current is set to a value that is noticeably different from the process value in order to signal the control system that the Transmitter is being worked at.

Configuration: Pg 49.

Current outputs

Loop current

The loop current is controlled by the process variable selected in the configuration.

The current start and end can be set to represent any desired value.

To check connected peripherals (e.g. limit switches, controllers), the loop current can be manually specified (see Pg. 74).

HART communication

The O₂ Transmitter 4100 e/2(X)H can be remote-controlled via HART communication. It can be configured using a handheld terminal or from the control room. Measured values, messages and device identification can be downloaded at any time. This allows easy integration also in fully automatic process cycles.

A list of the HART commands can be found in the "O₂ Transmitter 4100 e/2(X)H Transmitter-Specific Command Specification": www.mtpro.com/transmitters.

Alarm

The alarm delay is configurable.

Error messages can also be signaled by a 22 mA loop current (see Configuration, Pg 49).





The alarm LED on the front panel can be configured as follows:

HOLD off:	Alarm: LED flashing
HOLD on:	Alarm: LED on. HOLD: LED flashing.





Passcodes (factory setting)

The passcodes allow fast access to the functions

Calibration

Key+passcode	Description	Page
 0000	Cal Info	73
 1001	Zero calibration	70
 1100	Slope calibration: for saturation	62
	for concentration	64
	Volume concentration (gas)	66
 1105	Product calibration Adjusting the zero / slope (product)	68
 1015	Temp probe adjustment	72

Configuration

Key+passcode	Description	Page
 0000	Error Info Display last error and erase	73
 1200	Configuration	34
 2222	Sensor monitor Display sensor current / temperature	73
 5555	Current source Specify output current	74

Passcode editor

Key+passcode	Description	Page
 1989	Administrator passcode Changing the passcodes	58

Configuration

In the Configuration mode you set the device parameters.

Activate



Activate with **conf**



Enter passcode "1200"* .
Edit parameter with \blacktriangleright and \blacktriangle ,
confirm/continue with **enter**.
(End with **conf** and then **enter**.)

Hold



HOLD icon

During configuration the Transmitter remains in the Hold mode for reasons of safety. The loop current is frozen (at its last value or at a preset fixed value, depending on the configuration), Sensoface is off, mode indicator "Configuration" is on. Red LED flashes when "HOLD ON" has been set.

Input errors



The configuration parameters are checked during the input. In the case of an incorrect input "Err" is displayed for approx. 3 sec. The incorrect parameters cannot be stored. Input must be repeated.

End



End with **conf**. The measured value and Hold are displayed alternately, "enter" flashes. End Hold mode with **enter**. The display shows the measured value. The output current remains frozen for another 20 s (HOLD icon on, "hourglass" flashes).

* Factory setting, for passcode editing, see Pg 58

Menu structure of configuration

The configuration steps are assigned to different menu groups:

- Current output (code: o1.)
- Temperature compensation (code: tc.)
- Correction (code: Co.)
- Calibration mode (code: CA.)
- Alarm settings (code: AL.)

With the arrow keys you can jump between the individual menu groups. Each menu group contains menu items for setting the parameters.



Example:

“o1.” is displayed with all menu items of the “Current output” menu group.

Pressing **enter** opens a menu item. The values are edited using the arrow keys. Pressing **enter** confirms/stores the settings.

Return to measurement: Press **conf**. Press **enter** to confirm safety prompt. After 20 sec the Transmitter will be in measuring mode again.

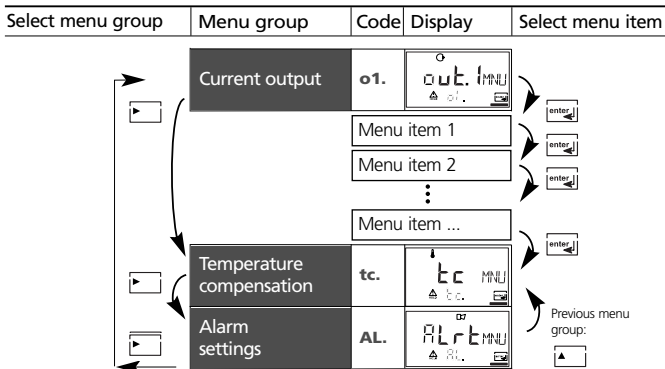

Overview of configuration steps

Code	Menu	Selection / Default
out1	Current output	(Factory setting bold print)
o1.FCT	Select process medium: dissolved oxygen (DO) / gas	DO / GAS
o1.SnSR	Select sensor type	Standard (Type A) / Traces (Type B)
o1.UnIT	Select: Saturation (SAt) / Concentration (Conc) Only with GAS selected: Volume concentration	% / µg/l, mg/l, ppb, ppm % / ppm
o1.4mA	Enter current start	xxxx (0000 %)
o1.20mA	Enter current end	xxxx (0500 %)
o1.FtME	Time constant of output filter	0000 ... 0120 SEC (0000 SEC)
o1.FAIL	22 mA signal for error messages	ON / OFF
o1.HoLD	Signal behavior during HOLD	LAST / FIX
o1.FIX	FIX: Enter FIX value	003.8 ... 022.0 mA (021.0 mA)
tc	Temperature compensation	
tc.UnIT	Select temperature unit	°C / °F
tc.rTD	Select temperature probe	22 NTC / 30 NTC
Corr	Correction	
Co.UPoL	Enter polarization voltage	0400 ... 1000 mV (0675 mV)
Co.UnIT	Select pressure unit	BAR / KPA / PSI
Co.PrES	Enter process pressure correction	xxxx (1.013 BAR)
Co.SAL	Enter salinity correction	00,00 ... 45.00 g/kg (00.00 ppt)
CAL	Calibration mode	
CA.MoD	Select calibration mode	SAt / Conc
CA.tiME	Selection of cal timer interval	0000 ... 9999 h / (0000 h)
ALrt	Alarm settings	
AL.SnSO	Select Sensocheck	ON / OFF
AL.dLY	Enter alarm delay	0000 ... 0600 SEC (0010 SEC)
AL.LED	LED in HOLD mode	ON / OFF



Individual settings

METTLER TOLEDO

(Original for copy)

Code	Parameter	Default settings	Individual settings
o1.FCT	Process medium	<u>DO</u>	<u> </u>
o1.SnSR	Sensor type	<u>Type A</u>	<u> </u>
o1.UnIT	Variable/Unit	<u>%</u>	<u> </u>
o1.4mA	Current start	<u>0000 %</u>	<u> </u>
o1.20mA	Current end	<u>0500 %</u>	<u> </u>
o1.FtME	Filter time	<u>0000 SEC</u>	<u> </u>
o1.FAIL	22mA signal	<u>OFF</u>	<u> </u>
o1.HoLD	Hold behavior	<u>LAST</u>	<u> </u>
o1.FIX	FIX current	<u>021.0 mA</u>	<u> </u>
tc.UnIT	Unit °C / °F	<u>°C</u>	<u> </u>
tc.rTD	Temp probe	<u>22 NTC</u>	<u> </u>
Co.UPoL	Polarization voltage	<u>675 mV</u>	<u> </u>
Co.UnIT	Pressure unit	<u>BAR</u>	<u> </u>
Co.PrES	Process pressure corr.	<u>1.013 BAR</u>	<u> </u>
Co.SAL	Salinity correction	<u>00.00 ppt</u>	<u> </u>
CA.MoD	Calibration mode	<u>SAt</u>	<u> </u>
CA.tIME	Cal timer interval	<u>0000 h</u>	<u> </u>
AL.SnSO	Sensocheck	<u>OFF</u>	<u> </u>
AL.dLY	Alarm delay	<u>0010 SEC</u>	<u> </u>
AL.LED	LED in Hold mode	<u>OFF</u>	<u> </u>

Configuration

Current output

Select process medium

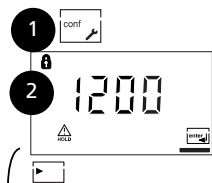

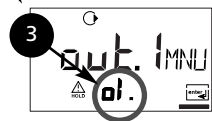

Current output:

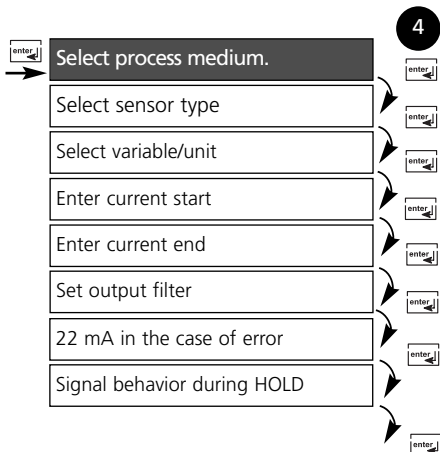

- 1: Press **conf** key.
- 2: Enter passcode 1200*.
- 3: Select **Current output** menu group using arrow keys. All items of this menu group are indicated by the code "01."
- 4: Press **enter** to select menu, edit with arrow keys (see Pg 39). Confirm (and proceed) with **enter**.
- 5: To end, press **conf**, then **enter**



Code	Display	Action	Choices
o1.		Select configuration (Press conf key).	
	 <p>After correct input a welcome text (CONF) is displayed for approx. 3 sec</p>	Enter passcode "1200"*. (Select position using arrow key ► and edit number using ▲. When the display reads "1200", press enter to confirm.)	
		The Transmitter is in HOLD mode (HOLD icon is on, red LED flashes when "HOLD ON" has been set.).	
	Select process medium: <ul style="list-style-type: none"> • Dissolved oxygen (DO) • Gas (GAS) Select with arrow key ► Proceed with: enter	DO (GAS)	

Note: Characters represented in gray are flashing and can be edited.

* Factory setting

Configuration

Current output

Select sensor type

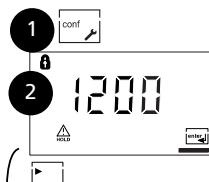

Current output:

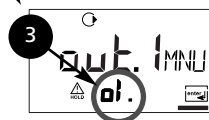

- 1: Press **conf** key.
- 2: Enter passcode **1200***.
- 3: Select **Current output** menu group using arrow keys. All items of this menu group are indicated by the code "o1."
- 4: Press **enter** to select menu, edit with arrow keys (see Pg 41). Confirm (and proceed) with **enter**.
- 5: To end, press **conf**, then **enter**

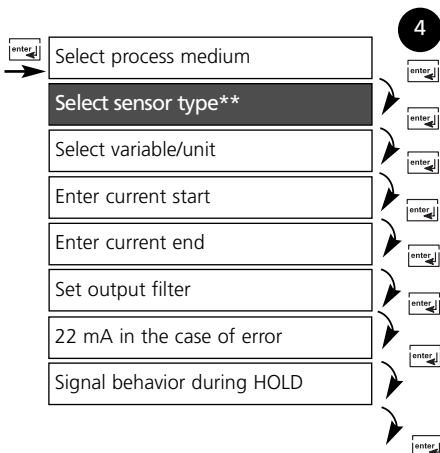

* Factory setting

Code	Display	Action	Choices
01.		Select sensor type A / B (see table on left-hand side) Select with arrow key ► Proceed with: enter	Type A (InPro6800) Type B (InPro6900)

** Type A sensors (standard applications)

Sensor type	Screw cap	Sensor current in air (25 °C)	Detection limit
InPro6800	4-pole (T82) VP	50 ... 110 nA typ. 60 nA	0.01 ppm 0.006 ppm

** Type B sensor (traces)

Sensor type	Screw cap	Sensor current in air (25 °C)	Detection limit
InPro6900	VP	typ. 350 nA	0.001 ppm

Note: Characters represented in gray are flashing and can be edited.

Configuration

Current output

Select process variable / unit

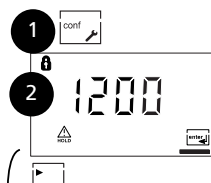



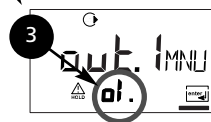

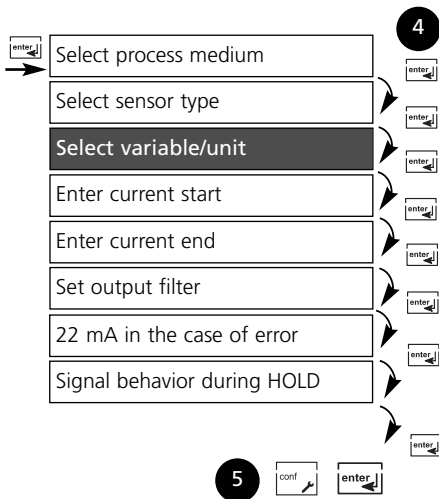

Current output:



- 1: Press **conf** key.
- 2: Enter passcode **1200***.
- 3: Select **Current output** menu group using arrow keys. All items of this menu group are indicated by the code "o1."
- 4: Press **enter** to select menu, edit with arrow keys (see Pg 43). Confirm (and proceed) with **enter**.
- 5: To end, press **conf**, then **enter**



* Factory setting

Code	Display	Action	Choices		
o1.		Select process variable / unit (valid for all following settings): Select with arrow key ►. Proceed with enter <ul style="list-style-type: none"> • SAt: Percent saturation: 0.0 ... 199,9 % 200 ... 500 % • Conc: Concentration (µg/l, mg/l, ppb or ppm) 0.00 ... 50.00 mg/l 0.00 ... 50.00 ppm 0000 ... 9999 µg/l 0000 ... 9999 ppb 	% (µg/l mg/l ppb ppm)		
					
					
					
					
				Only with measurement in gas (GAS) selected: Select process variable (valid for all following settings): Select with arrow key ► Proceed with: enter	% (ppm)
					

Note: Characters represented in gray are flashing and can be edited.

Configuration

Current output

Current start / end

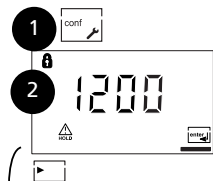

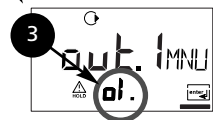

Current output:

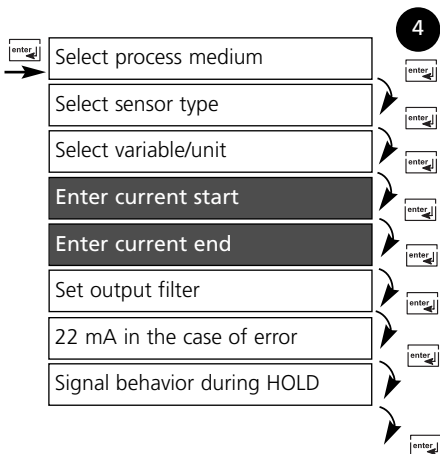

- 1: Press **conf** key.
2. Enter passcode **1200**.*
3. Select **Current output** menu group using arrow keys.
All items of this menu group are indicated by the code "o1."
4. Press **enter** to select menu, edit with arrow keys (see Pg 45).
Confirm (and proceed) with **enter**.
5. To end, press **conf**, then **enter**



* Factory setting

Code	Display	Action	Choices
o1.		Current start Enter lower end of scale, depending on the measurement procedure selected (Saturation or Concentration) Select with ► key, edit number with ▲ key, proceed with enter	0000 % (corresponding to selected range: µg/l mg/l ppb ppm)
		Current end Enter upper end of scale, depending on the measurement procedure selected (Saturation or Concentration) Select with ► key, edit number with ▲ key, proceed with enter	0500 % (corresponding to selected range: µg/l mg/l ppb ppm)

Assignment of measured values: Current start and current end

Example 1: Range 0 to 100 %

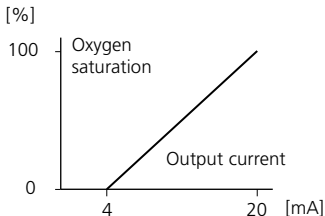

Example 2: Range 50 to 70%.

Advantage: Higher resolution in
range of interest

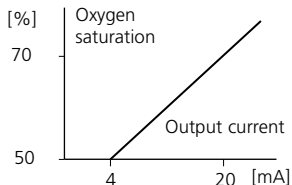

Configuration

Current output

Output filter: Time constant

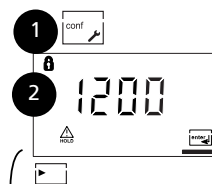

Current output:

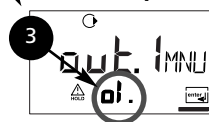

- 1: Press **conf** key.
- 2: Enter passcode **1200***.
- 3: Select **Current output** menu group using arrow keys.
All items of this menu group are indicated by the code "o1."
- 4: Press **enter** to select menu, edit with arrow keys (see Pg 47).
Confirm (and proceed) with **enter**.
- 5: To end, press **conf**, then **enter**

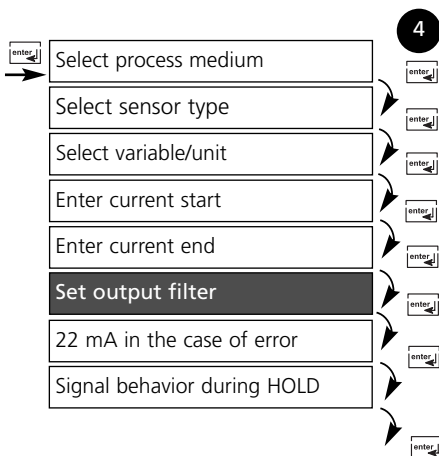

* Factory setting

Code	Display	Action	Choices
o1.		Time constant of output filter Default setting: 0 s (inactive). To specify a time constant: Select with ► key, edit number with ▲ key, proceed with enter	0000 SEC (0000 - 0120 SEC)

Time constant of output filter (attenuation)

To smoothen the current output, a low-pass filter with adjustable filter time constant can be switched on. When there is a jump at the input (100 %), the output level is at 63 % after the time constant has been reached. The time constant can be set from 0 to 120 sec. If the time constant is set to 0 s, the current output follows the input.

Note:

The filter only acts on the current output, not on the display!

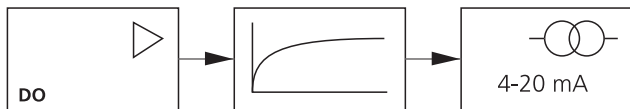

Time constant 0 to 120 sec

Configuration

Current output

Output current during Error and HOLD

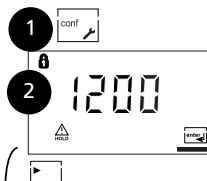

Current output:

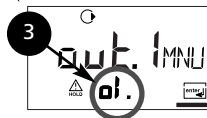

- 1: Press **conf** key.
- 2: Enter passcode **1200***.
- 3: Select **Current output** menu group using arrow keys. All items of this menu group are indicated by the code "o1."
- 4: Press **enter** to select menu, edit with arrow keys (see Pg 49). Confirm (and proceed) with **enter**.
- 5: To end, press **conf**, then **enter**

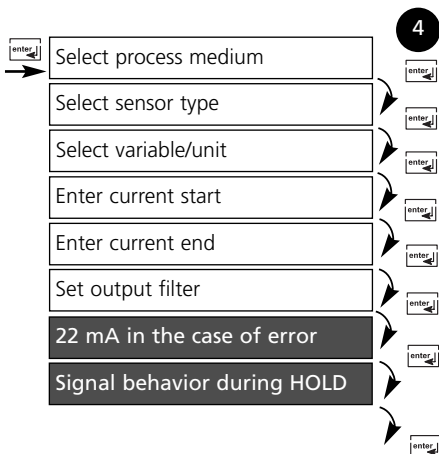

* Factory setting

Code	Display	Action	Choices
01.		22 mA signal for error message Select with arrow key ► Proceed with: enter	OFF (ON)
		Output signal during HOLD LAST: During HOLD the last measured value is maintained at the output FIX: During HOLD a value (to be entered) is maintained at the output Select with arrow key ► Proceed with: enter	LAST (FIX)
	 	Only with FIX selected: Enter current which is to flow at the output during HOLD Select position with arrow key ► and edit number with ▲ key Proceed with: enter	021.0 mA (003.8 ... 022.0 mA)

Output signal for HOLD:

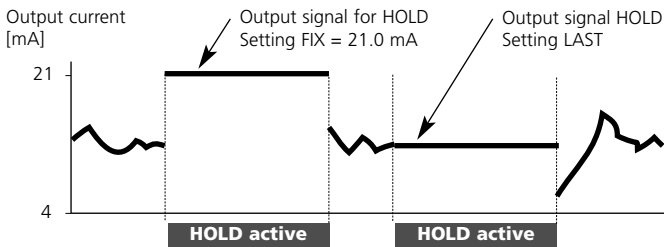



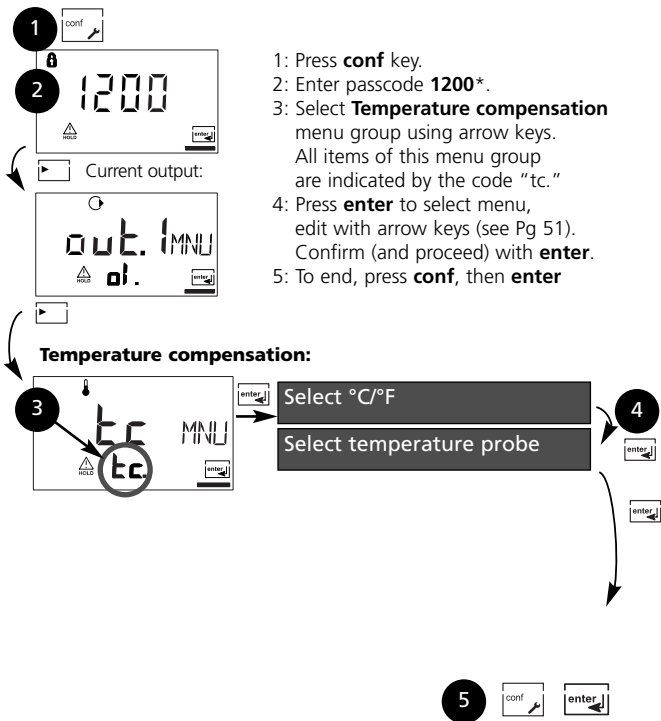

Configuration

Temperature compensation

Temperature unit, temperature probe



Code	Display	Action	Choices
tc.		Specify temperature unit	°C (°F)
		Select with arrow key ► Proceed with: enter	
		Select temperature probe	22NTC (30NTC)
		Select with arrow key ► Proceed with: enter	

Configuration



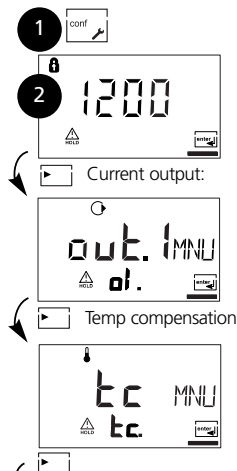

Correction: Polarization voltage, process pressure, salinity correction

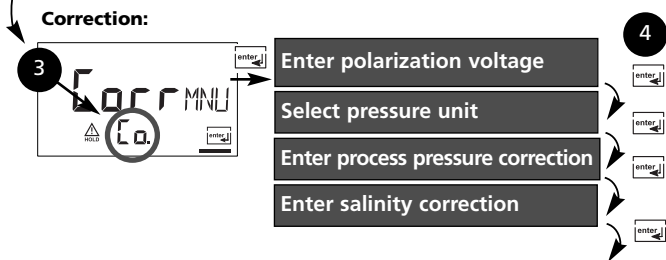

- 1: Press **conf** key.
- 2: Enter passcode **1200**.
- 3: Select **Correction** menu group using arrow keys.
All items of this menu group are indicated by the code "Co."
- 4: Press **enter** to select menu, edit with arrow keys (see Pg 53). Confirm (and proceed) with **enter**.
- 5: To end, press **conf**, then **enter**



* Factory setting



Code	Display	Action	Choices
Co.		Enter polarization voltage Select with ► key, edit number with ▲ key, proceed with enter	0675 mV (0400 ... 1000 mV)
		Select pressure unit Select with arrow key ► Proceed with: enter	bar (kPa, PSI)
		Process pressure correction Enter process pressure. This value is used to correct oxygen saturation. It has no influence on concentration measurement (Conc). Select position with arrow key ► and edit number with ▲ key. Proceed with: enter	1.013 bar (0.000 ... 9.999 bar 0.000 ... 999.0 kPa, 0.000 ... 145.0 PSI)
		Enter salinity correction Select position with arrow key ► and edit number with ▲ key. Proceed with: enter	00.00 ppt* (00.00 ... 45.00 ppt)

* ppt (parts per thousand) - corresponds to g/kg

Configuration

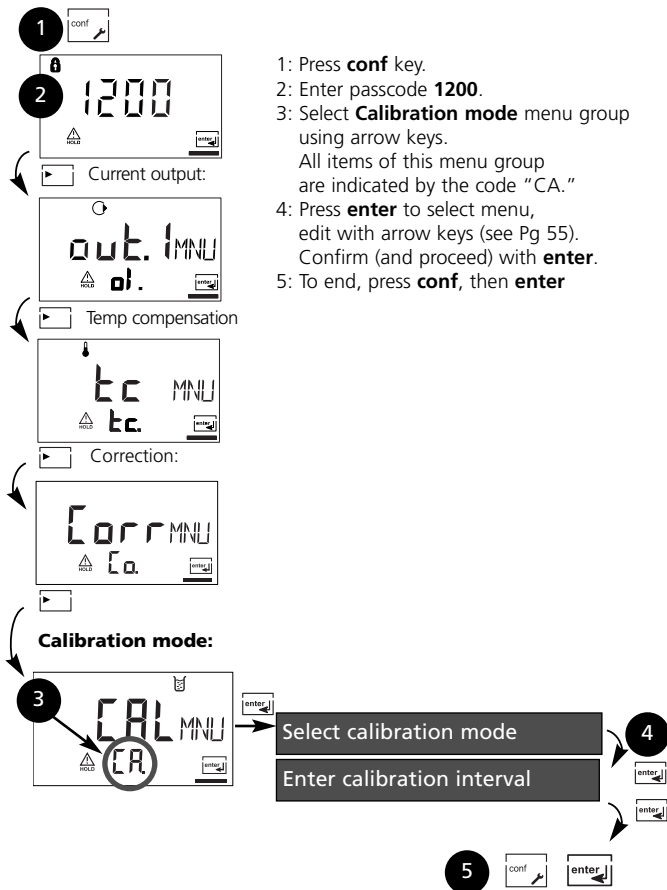
Calibration mode



Code	Display	Action	Choices
CA.		Specify calibration mode (Calibration to saturation or concentration) Select with ► key, proceed with enter	SAt (Conc)
		Cal timer interval The cal timer reminds you to cali- brate in time. Select with ► key, edit number with ▲ key, proceed with enter	0000 h (0000 ... 9999 h)

Configuration

Alarm settings

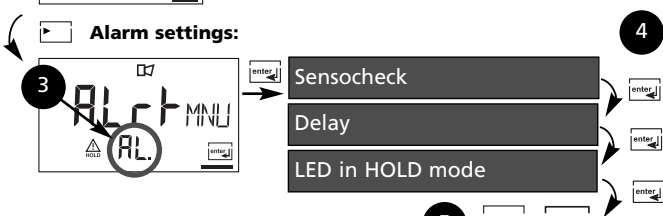
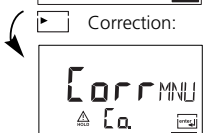
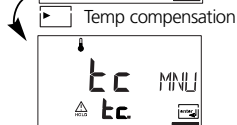
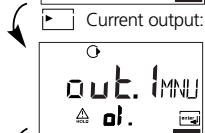
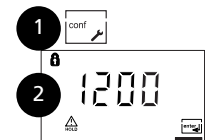

* Factory setting

- 1: Press **conf** key.
- 2: Enter passcode **1200**.
- 3: Select **Alarm settings** menu group using arrow keys.
All items of this menu group are indicated by the code "AL."
- 4: Press **enter** to select menu, edit with arrow keys (see Pg 57).
Confirm (and proceed) with **enter**.
- 5: To end, press **conf**, then **enter**







Code	Display	Action	Choices								
AL.		Select Sensocheck (continuous monitoring of sensor) Select with ► key, proceed with enter With sensor type B Sensocheck must be switched off	ON / OFF								
		Alarm delay Select with ► key, edit number with ▲ key, proceed with enter	0010 SEC (0000 ... 0600 SEC)								
		LED in HOLD mode Select with ► key, edit number with ▲ key, proceed with enter LED state: <table border="1" data-bbox="393 828 808 956"> <thead> <tr> <th>Setting</th> <th>Alarm</th> <th>HOLD</th> </tr> </thead> <tbody> <tr> <td>ON</td> <td>on</td> <td>flashes</td> </tr> <tr> <td>OFF</td> <td>flashes</td> <td>off</td> </tr> </tbody> </table>	Setting	Alarm	HOLD	ON	on	flashes	OFF	flashes	off
Setting	Alarm	HOLD									
ON	on	flashes									
OFF	flashes	off									







Passcodes according to FDA 21 CFR Part 11

Access to the device functions can be protected with adjustable passcodes if required.

If such a protection is not required, you should use the preset passcodes.

To call up passcode editor: Press **conf** key and enter Administrator passcode (Factory setting: **1989**).

Display	Action	Remark
	1: Press conf key. 2: Enter Administrator passcode (1989): Welcome text is displayed	This text is displayed for approx. 3 sec
	"Cal Info" Edit: Arrow keys Proceed with: enter Cancel: conf	Default setting: 0000
	"Cal zero" Edit: Arrow keys Proceed with: enter Cancel: conf	Default setting: 1001
	"Calibration Sat/Conc" Edit: Arrow keys Proceed with: enter Cancel: conf	Default setting: 1100
	"Product calibration" Edit: Arrow keys Proceed with: enter Cancel: conf	Default setting: 1105
	"Temp probe adjustment" Edit: Arrow keys Proceed with: enter Cancel: conf	Default setting: 1015

Display	Action	Remark
	<p>"Error Info" Edit: Arrow keys Proceed with: enter Cancel: conf</p>	Default setting: 0000
	<p>"Configuration" Edit: Arrow keys Proceed with: enter Cancel: conf</p>	Default setting: 1200
	<p>"Sensor monitor" Edit: Arrow keys Proceed with: enter Cancel: conf</p>	Default setting: 2222
	<p>"Current source" Edit: Arrow keys Proceed with: enter Cancel: conf</p>	Default setting: 5555
	<p>"Administrator passcode" Edit: Arrow keys Proceed with: enter. Cancel: conf</p>	Default setting: 1989
	<p>New "Administrator passcode" Select "NO" / "YES" with arrow keys</p>	<p>Caution! If you have lost the Administrator passcode, the Passcode Editor cannot be called up! Please consult our technical support!</p>
	<p>"NO" enter = old passcode Cancel: conf = old passcode</p>	
	<p>"YES" enter = take over new passcode Cancel: conf = old passcode</p>	

Calibration

Calibration adjusts the device to the sensor.

Activate



Activate with **cal**



Enter passcode

- 1001: Zero calibration
- 1100: Saturation/Concentration
Volume concentration (GAS)
- 1105: Product calibration

Edit parameter with **▶** and **▲**,
confirm / continue with **enter**.
(End with **cal** and **enter**.)

Hold



During calibration
the Transmitter
remains in the
Hold mode.



HOLD icon

The loop current is frozen (at its last
value or at a preset fixed value,
depending on the configuration),
Sensoface is off, mode indicator
"Calibration" is on.
Red LED flashes when "HOLD ON"
has been set.

Input errors

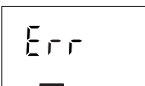

The calibration parameters are
checked during the input.
In the case of an incorrect input "Err"
is displayed for approx. 3 sec.
The incorrect parameters cannot be
stored. Input must be repeated.

End



End with **cal**.

Safety prompt:

The measured value and Hold are
displayed alternately, "enter" flashes.
Press **enter** to end the Hold mode.
The measured value is displayed.
The output current remains frozen for
another 20 sec (HOLD icon on,
"hourglass" flashes).

Calibration

It is always recommended to calibrate in air.

Compared to water, air is a calibration medium which is easy to handle, stable, and thus safe. In the most cases, however, the sensor must be dismounted for a calibration in air.

When dealing with biotechnological processes which require sterile conditions, the sensor cannot be removed for calibration. Here, calibration must be performed with aeration directly in the process medium (e.g. after sterilization).

In the field of biotechnology, for example, often saturation is measured and calibration is performed in the medium for reasons of sterility.

For other applications where concentration is measured (water control etc.), calibration in air has proved to be useful.

Common combination: process variable / calibration mode

Measurement	Calibration
Saturation	Water
Concentration	Air (synthetic air)
Volume concentration	Air





The calibration procedures for these two common applications are described on the following pages. Of course, other combinations of process variable and calibration mode are possible.



Note:

When a 2-point calibration is required, the zero calibration should be performed prior to saturation or concentration calibration, resp. (see Pg 70).

All calibration procedures must be performed by trained personnel.

Calibration to saturation (SAT)





Display	Action	Remark
	Activate calibration (Press cal.) Enter passcode 1100. Select with ► key, edit number with ▲ key, proceed with enter	SAT or Conc calibration is selected during configuration. If an invalid passcode is entered, the Transmitter returns to measuring mode.
	Place sensor in calibration medium Start with enter	Welcome (3 sec) The Transmitter is in the Hold mode.
	Enter relative humidity Select with ► key, edit number with ▲ key, proceed with enter	Default for relative humidity in aqueous media: rH = 100 % (in air approx. 50 %)
	Enter calibration pressure Select with ► key, edit number with ▲ key, proceed with enter	Default for calibra- tion pressure is the process pressure configured
	Automatic drift check Display of sensor current (related to 25 °C and 1013 mbars normal pressure) and measuring temperature. The drift check might take some time.	Drift check can be stopped after > 10 sec by pressing cal (accuracy reduced).



Display	Action	Remark
	<p>Enter desired value for saturation Select with ► key, edit number with ▲ key, proceed with enter</p>	<p>Default: last value entered</p>
	<p>Display new slope and zero (related to 25°C and 1013 mbars). End calibration with enter.</p>	
	<p>Place sensor in process. The percent saturation is shown in the main display alternately with "Hold"; "enter" flashes. Stop Hold with enter.</p>	<p>After end of calibration, the outputs remain in Hold mode for approx. 20 sec.</p>

Information on saturation calibration (SAT)

- The calibration medium must be in equilibrium with air (percent saturation for water is 100 %). Oxygen exchange between water and air is very slow. To speed up the adjustment processes, make sure that there is a steady medium flow during calibration.
- If the percent saturation is known from a simultaneous measurement, it can be entered manually.
- For 2-point calibration, perform zero point calibration first, see Pg. 70

Calibration to concentration (Conc)

Display	Action	Remark
	Activate calibration (Press cal.) Enter passcode 1100. (Press ► key to select position, enter number using ▲ key, confirm with enter)	SAT or Conc calibration is selected during configuration. If an invalid passcode is entered, the Transmitter returns to measuring mode.
	Place sensor in air Start with enter	The Transmitter is in the Hold mode
	Enter relative humidity (Press ► key to select position, enter number using ▲ key, confirm with enter)	Default for relative humidity in air: rH = 50 %
	Enter calibration pressure (Press ► key to select position, enter number using ▲ key, confirm with enter)	Default for calibration pressure is normal pressure 1.013 bars.
	Automatic drift check Display of input current (related to 25 °C and 1013 mbars) and measuring temperature. The drift check might take some time.	Drift check can be stopped after > 10 sec by pressing cal (accuracy reduced).

Display	Action	Remark
	<p>Enter default for concentration (Press ► key to select position, enter number using ▲ key, confirm with enter)</p>	<p>Default value is calculated from rel. humidity, cal pressure and cal temperature.</p> <p>(The unit of measurement, ppm or mg/l, ... is preset during configuration.)</p>
	<p>Display of new slope and zero (related to 25 °C and 1013 mbars)</p> <p>Press enter to end concentration calibration.</p>	
	<p>Place sensor in process</p> <p>The new value is shown in the main display alternately with "Hold"; "enter" flashes.</p> <p>End with enter.</p>	<p>After end of calibration, the outputs remain in Hold mode for approx. 20 sec.</p>





Information on concentration calibration (Conc)



Calibration in air. This calibration method is recommended when the sensor can be removed for calibration. Air has a stable oxygen content. Therefore the adjustment processes during calibration run more quickly.

- For 2-point calibration, perform zero point calibration first, see Pg. 70

Calibration to volume concentration

(GAS) Calibration medium: air

Display	Action	Remark
	Activate calibration (Press cal.) Enter passcode 1100. (Press ► key to select position, enter number using ▲ key, confirm with enter)	GAS must have been selected during configura- tion. If an invalid passcode is entered, the Transmitter returns to measuring mode.
	Place sensor in air	Welcome (3 sec) the Transmitter is in the Hold mode.
	Enter relative humidity (Press ► key to select position, enter number using ▲ key, confirm with enter)	Default for relative humidity in air: rH = 50 %
	Enter calibration pressure (Press ► key to select position, enter number using ▲ key, confirm with enter)	Default for calibra- tion pressure is normal pressure 1.013 bars.
	Automatic drift check Display of input current (related to 25 °C and 1013 mbars) and measuring temperature. The drift check might take some time.	Drift check can be stopped after > 10 sec by pressing cal (accuracy reduced).

Display	Action	Remark
	<p>Display of new slope and zero (related to 25 °C and 1013 mbars)</p> <p>Press enter to end concentration calibration.</p>	
	<p>Place sensor in process</p> <p>The new value is shown in the main display alternately with "Hold"; "enter" flashes. Stop Hold with enter.</p>	<p>After end of calibration, the outputs remain in Hold mode for approx. 20 sec.</p>

Please note:

- For 2-point calibration, perform zero point calibration first, see Pg. 70

Product calibration

Calibration with sampling

Can be performed for all process variables: saturation, concentration, volume concentration.

During product calibration the sensor remains in the process.



The measurement process is only interrupted briefly.







Procedure: During sampling the currently measured value is stored in the Transmitter. The Transmitter immediately returns to measuring mode.

The calibration mode indicator flashes and reminds you that calibration has not been terminated. The comparison value is measured on the site, e.g. using a portable DO meter in a bypass. This value is then entered in the Transmitter. The new value for slope or zero is calculated from the stored value and the comparison value. From the measured value, the Transmitter automatically recognizes whether a new slope or zero must be calculated (above approx. 5 % saturation: slope, below: zero).

If the sample is invalid, you can take over the measured value stored during sampling instead of the comparison value. In that case the old calibration values remain stored. Afterwards, you can start a new product calibration.

The following describes a product calibration with slope correction – a product calibration with zero correction is performed correspondingly.

Display	Action	Remark
	<p><u>Product calibration step 1:</u> Activate calibration (Press cal key). Enter passcode 1105. (Select with ▶ key, edit number with ▲ key, proceed with enter)</p>	<p>The type of product calibration (SAT or Conc) is selected during configuration (Process variable). If an invalid passcode is entered, the Transmitter returns to measuring mode.</p>
		<p>Display for approx. 3 sec</p>

Display	Action	Remark
	<p>Take sample and store the currently measured value. Proceed with enter</p>	<p>Now the comparison value must be determined. The Transmitter goes to measuring mode.</p>
	<p>Measuring mode</p>	<p>From the flashing CAL mode indicator you see that product calibration has not been terminated.</p>
	<p>Product calibration 2nd step: When a comparison value has been determined, call up the product calibration once more (cal key, passcode 1105).</p>	<p>Display (approx. 3 sec)</p>
	<p>Enter the comparison value. Confirm with enter.</p>	<p>Calculation of new slope.</p>
	<p>Display of new slope and zero point (related to 25 °C at 1013 mbars) End calibration with enter</p>	<p>New calibration: Press cal key.</p>
	<p>The measured value is shown in the main display alternately with "Hold"; "enter" flashes. Stop Hold with enter.</p>	<p>After end of calibration, the outputs remain in Hold mode for approx. 20 sec.</p>





Zero calibration

Zero calibration

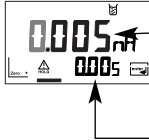

The Series InPro6800/InPro6900 sensors have a very low zero point current. Therefore, a zero point calibration is only recommended for measurement of oxygen traces. If a zero calibration is performed, the DO sensor should remain for at least 10 to 30 minutes in the calibration medium in order to obtain stable, non-drifting values (InPro6900: at least 60 min).

During zero point calibration, a drift check is not performed. Zero point current of a properly functioning sensor is notably less than 0.5 % of air current. The display (secondary: measured value, main: entered value) does not change until an input current is entered for the zero point.

When measuring in an oxygen-free medium, the displayed current can be taken directly.





Display	Action	Remark
	<p>Activate calibration (Press cal key). Enter passcode 1001. Select with ▶ key, edit number with ▲ key, proceed with enter</p>	<p>The Transmitter is in the Hold mode. If an invalid pass-code is entered, the Transmitter returns to measuring mode.</p>
	<p>Place sensor in oxygen-free medium</p>	<p>Welcome (3 sec)</p>
	<p>Main display: Zero point current; store with enter or correct with arrow keys and then store with enter. Lower display: Sensor current measured</p>	
	<p>Display of slope Display of new zero point current End calibration with enter key, place sensor in process</p>	
	<p>The oxygen value is shown in the main display alternately with "Hold"; "enter" flashes. Stop Hold with enter.</p>	<p>Safety prompt</p> <p>The outputs remain in Hold mode for approx. 20 sec.</p>

Temperature probe adjustment

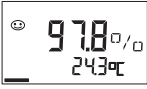
Display	Action	Remark
	Activate calibration (press cal key) Enter passcode 1015. Select with ▶ key, edit number with ▲ key, proceed with enter	Wrong settings change the measurement properties! If an invalid passcode is entered, the Transmitter returns to measuring mode.
	Ready for calibration	The Transmitter is in the Hold mode. Display for approx. 3 s
	Measure the temperature of the process medium using an external thermometer. Enter measured temperature value: Select with ▶ key, edit number with ▲ key, proceed with enter . End adjustment with enter . HOLD will be deactivated after 20 sec.	Default: Current value of secondary display

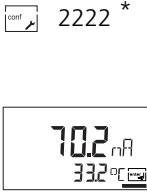

Measurement

Display	Action / Remarks
	In the measuring mode the main display shows the configured process variable (% , mg/l or ppm), the lower display shows the temperature. During calibration you can return to measuring mode by pressing the cal key, during configuration by pressing the conf key. (Waiting time for measured value stabilization approx. 20 sec).

Display	Action / Remarks
	<p>Display of the output current Press enter while in measuring mode. The output current is shown in the main display. After 5 sec the Transmitter returns to measuring mode.</p>
	<p>Display of calibration data (Cal Info) Press cal while in measuring mode and enter passcode 0000*. The slope is shown in the main display, the zero point current in the secondary display. After 20 sec the Transmitter returns to measuring mode (immediate return at pressing enter).</p>
	<p>Display of sensor current (Sensor monitoring for validation of sensor and complete measured-value processing) Press conf while in measuring mode and enter passcode 2222*. The (uncompensated) sensor current is shown in the main display, the measuring temp in the secondary display. Press enter to return to measurement.</p>
	<p>Display of last error message (Error info) Press conf while in measuring mode and enter passcode 0000*. The last error message is displayed for approx. 20 sec. After that the message will be deleted (immediate return to measurement at pressing enter).</p>

* Factory setting

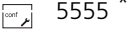
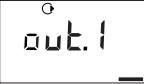





















Diagnostics functions

Display	Action / Remarks
  	<p>Specify output current for testing the connected peripherals Press conf while in measuring mode and enter passcode 5555*. The actually measured current is shown in the secondary display. The output current indicated in the main display can be modified. Select with ► key, edit number with ▲ key. Confirm with enter key. Then the entered value will be shown in the secondary display. The Transmitter is in Hold mode. Press conf, then enter to return to measurement (Hold remains active for another 20 sec).</p>

Cleaning

To remove dust, dirt and spots, the external surfaces of the device may be wiped with a damp, lint-free cloth.
A mild household cleaner may also be used if necessary.

* Factory setting

Operating state	Out	LED	Time out
Measuring			
Cal Info (cal) 0000*			20 sec
Error Info (conf) 0000*			20 sec
Calibration (cal) 1100*			
Zero calibration (cal) 1001*			
Temp adjustment (cal) 1015*			
Product calibration step 1 (cal) 1105* step 2 (cal) 1105*	 	 	
Configuration (conf) 1200*			20 min
Sensor monitor (conf) 2222*			20 min
Current source (conf) 5555*			20 min

Explanation:



active



as configured (Last/Fix or Last/Off)











LED flashes during HOLD (configurable)



* Factory setting

Error messages (Error Codes)

Error	Display	Problem Possible causes	Red LED	Out 1 (22 mA)
ERR 01	Measured value flashes	SAT range Sensor defective Wrong sensor connected Measurement range exceeded	x	x
ERR 02	Measured value flashes	Conc range Sensor defective Wrong sensor connected Measurement range exceeded	x	x
ERR 98	"Conf" flashes	System error Configuration or calibration data defective; completely reconfigure and recalibrate the device Memory error in device program (PROM defective)	x	x
ERR 99	"FAIL" flashes	Factory settings EEPROM or RAM defective This error message only occurs in the case of a total defect. The Transmitter must be repaired and recalibrated at the factory.	x	x

Error	Icon (flashes)	Problem Possible causes	Red LED	Out 1 (22 mA)
ERR 03		Temperature probe Open or short circuit Temperature range exceeded	x	x
ERR 11		Current output Current below 0 (3.8) mA	x	x
ERR 12		Current output Current above 20.5 mA	x	x
ERR 13		Current output Current span too small / too large	x	x
ERR 33		Sensocheck Sensor: Connecting cable defective	x	x
		<ul style="list-style-type: none"> • Zero error, Sensoface active, see Pg 80 		
		<ul style="list-style-type: none"> • Slope error, Sensoface active, see Pg 80 		
		<ul style="list-style-type: none"> • Response time exceeded, Sensoface active, see Pg 80 		
		<ul style="list-style-type: none"> • Calibration interval expired, Sensoface active, see Pg 80 		

Calibration error messages

Symbol flashes:	Problem Possible causes
	Slope out of range <ul style="list-style-type: none">•Wrong calibration values specified (relative humidity, pressure, saturation, concentration)•Wrong calibration medium
 <p>In addition "CAL Err" flashes.</p>	Calibration aborted after 12 minutes <ul style="list-style-type: none">•Sensor defective or dirty•No electrolyte in the sensor•Sensor cable insufficiently shielded or defective•Strong electric fields influence the measurement•Temperature fluctuation of calibration solution











Sensoface

(Sensochek must have been activated during configuration.)

The little smiley in the display (Sensoface) alerts to sensor problems (defective cable, maintenance required).

The permitted calibration ranges and the conditions for a friendly, neutral, or sad Sensoface are summarized in the following chart. Additional icons refer to the error cause. Replace membrane module or filling solution, if required.

Type A sensors (InPro6800)











	Slope	Zero point	Response time	Cal timer
Adm. Range	25 ... 130 nA	-2 ... +2 nA	max. 720 sec	
	> 35 ... < 90 nA	> - 0,5 ... < 0.5 nA	≤ 300 sec	≤ 80 % expired
	 30 ... 35 nA or 90 ... 110 nA	 -1.0 ... -0.5 nA or +0.5 ... +1.0 nA	 300 ... 600 sec	 80 ... ≤ 100 % expired
	 < 30 nA or > 110 nA	 < -1.0 nA or > +1.0 nA	 > 600 sec	 Timer expired

Note

The worsening of a Sensoface criterion leads to the devaluation of the Sensoface indicator (Smiley becomes "sad").

An improvement of the Sensoface indicator can only take place after calibration or removal of a sensor defect.

Type B sensor (InPro6900)

	Slope	Zero point	Response time	Cal timer
Adm. Range	200 ... 550 nA	-2 ... +2 nA	max. 720 s	
	> 250 ... < 500 nA	> -0.5 ... < 0.5 nA	< 300 sec	< 80 % expired
	 225 ... 250 nA or 500 ... 525 nA	 -1.0 ... -0.5 nA or +0.5 ... +1.0 nA	 300 ... 600 sec	 80 ... ≤ 100 % expired
	 < 225 nA or > 525 nA	 < -1.0 nA or > +1.0 nA	 > 600 s	 Timer expired



Thermometer and Sensoface:

Temperature out of concentration or saturation range

Sensocheck

Continuously monitors the sensor and leads for short circuits or open circuits. Critical values make the Sensoface "sad" and the corresponding icon flashes: 

The Sensocheck message is also output as error message Err 33. The alarm contact is active, the red LED is lighted, output current 1 is set to 22 mA (when configured correspondingly). Sensocheck can be switched off during configuration (then Sensoface is also disabled). Exception: After a calibration a Smiley is always displayed for confirmation.

Note

With sensor type B Sensocheck must be switched off!

Product line and accessories

Devices	Order no.
---------	-----------

O ₂ Transmitter 4100 e/2H	52 121 215
O ₂ Transmitter 4100 e/2XH	52 121 168

Mounting accessories

Pipe-mount kit	52 120 741
Panel-mount kit	52 120 740
Protective hood	52 120 739

Sensors

Mettler-Toledo GmbH, Process Analytics offers a wide range of sensors for the following fields of applications:

- Chemical process industry
- Pharmaceutical industry
- Food and beverage industry
- Water/waste-water

For more information concerning our sensors and housings program, please refer to <http://www.mt.com>.

Specifications

DO input

	Sensor Type A:	InPro6800
	Sensor Type B:	InPro6900
Measuring current	0 ... 1200 nA,	Resolution: 20 pA
Measurement error ^{1,2,3)}	0.5% m.val. + 0.05 nA TC:	0.005 nA/K
Ranges*	Saturation (-10 ... 80 °C)	
	0.0 ... 199.9 % / 200 ... 500 %	
	(autom. switchover in display)	
	Concentration (-10 ... 80 °C)	
		0.00 ... 50.00 mg/l
		0.00 ... 50.00 ppm
		0000 ... 9999 µg/l
		0000 ... 9999 ppb
	Volume concentration in gas (-10 ... 80 °C)	
		0000 ... 9999 ppm
		0.0 ... 120 %
	Display: (0.00 ... 29.99 % / 30.0 ... 120.0 %)	
Adm. guard current	≤ 20 µA	
Polarization voltage*	400 ... 1000 mV	
Process pressure*	0.000 ... 9.999 bars (... 999.9 kPa / ... 145.0 PSI)	
Salinity correction*	00.00 ... 45.00 g/kg	
Sensor standardization		
Operating modes*	<ul style="list-style-type: none">• O₂ saturation (automatic)• O₂ concentration (automatic)• Volume concentration (gas)• Product calibration• Zero calibration	
Calibration range	Zero point	± 2 nA
Sensor type A	Slope	25 ... 130 nA (at 25°C, 1013 mbars)
Calibration range	Zero point	± 2 nA
Sensor type B	Slope	200 ... 550 nA (at 25°C, 1013 mbars)
Cal timer*	0000 ... 9999 h	
Pressure correction*	0.000 ... 9.999 bars (... 999.9 kPa / ... 145.0 PSI)	

Sensocheck	Monitoring for short circuits / open circuits (can be disabled), delay: 30 sec
Sensoface	Provides information on the sensor condition evaluation of zero point/slope, response time, calibration interval, Sensocheck
Sensor monitor	Direct display of measured values from sensor for validation (uncompensated sensor current, measuring temp)
Temperature input*	NTC 22 kOhm / NTC 30 kOhm 2-wire connection, adjustable
Range	-20.0 ... +150.0 °C / -4 ... +302 °F
Adjustment range	10 K
Resolution	0.1 °C / 1 °F
Measurement error ^{1,2,3)}	< 0.5 K (< 1 K at T > 100°C)
Supply/Output	
Loop current	4 ... 20 mA (22 mA), floating (3.8 ... 20.5 mA)
Supply voltage	12 ... 30 V, I _{max} = 100 mA, P _{max} = 0.8 W (Ex)
Process variable*	O ₂ saturation / O ₂ concentration
Characteristic	Linear
Overrange ¹⁾	22 mA in the case of error messages
Output filter*	Low-pass, PT ₁ , filter time constant 0 ... 120 sec
Measurement error ¹⁾	< 0.3 % current value + 0.05 mA
Start/end of scale	As desired within range
Adm. span	2 % ... 500 % Gas: 500 ... 9999 ppm 200 ... 9999 µg/l 1 ... 120 % 200 ... 9999 ppb 0.5 ... 50 mg/l 0.5 ... 50 ppm
Current source function	3.8 mA ... 22 mA

Specifications

HART communication

Digital communication by FSK modulation of loop current, reading of device identification, measured values, status and messages, reading and writing of parameters, start of product calibration, signaling of configuration changes according to FDA 21 CFR Part 11

Display

Main display

LC display, 7-segment with icons

Secondary display

Character height 17 mm, unit symbols 10 mm

Sensoface

Character height 10 mm, unit symbols 7 mm

3 status indicators

(friendly, neutral, sad)

Mode indicator

4 indicators: "meas", "cal", "alarm", "config"
18 further icons for configuration and messages

Alarm indication

Red LED in case of alarm or HOLD, user defined

Keypad

5 keys: [cal] [conf] [▶] [▲] [enter]

Service functions

Current source

Loop current specifiable 3.8 ... 22.00 mA

Device self-test

Automatic memory test (RAM, FLASH, EEPROM)

Display test

Display of all segments

Last Error

Display of last error occurred

Sensor monitor

Display of direct, uncorrected sensor signal
(sensor current/temperature)

Passcodes

Modifiable according to FDA 21 CFR Part 11
"Electronic Signatures"

* User-defined

1) To IEC 746 Part 1, at nominal operating conditions

2) ± 1 count

3) Plus sensor error

Data retention Parameters and cal data > 10 years (EEPROM)

EMC

EN 61326
 Emitted interference: Class B (residential area)
 Class A
 Immunity to interference: Industry
 Lightning protection EN 61000-4-5, Installation Class 2

Explosion protection

4100 e/2XH: ATEX: TÜV 04 ATEX 2431
 II 2(1) G EEx ib[ia] IIC T6
 FM: FMRC 3023119
 IS/I/1/ABCD/T4; Entity; Type 2
 I/O/AEx ia IIC T4; Entity; Type 2
 NI/2/ABCD/T4; Type 2
 AIS/I, II, III/1/ABCDEFG
 CSA: 1662790
 CI I, Div 1, Gr ABC & D T4; Ex ib [ia] IIC T4
 CI I, Div 2, Gr ABC & D, T4; Ex nAL[L] IIC T4
 4100 e/2H: FM: FM 300580 / FM 3023119
 NI/2/ABCD/T4

Nominal operating conditions

Ambient temperature -20 ... +55 °C
 Transport/Storage temp -20 ... +70 °C
 Relative humidity 10 ... 95% not condensing
 Supply voltage 12... 30 V

Specifications

Enclosure	Molded enclosure made of PBT (polybutylene terephthalate)
Color	Bluish gray RAL 7031
Assembly	<ul style="list-style-type: none">• Wall mounting• Pipe mounting:<ul style="list-style-type: none">Ø 40 ... 60 mm, □ 30 to 45 mm• Panel mounting, cutout to DIN 43 700 Sealed against panel
Dimensions	H 144 mm, W 144 mm, D 105 mm
Protection	IP 65/NEMA 4X (USA, Canada: indoor use only)
Cable glands	3 breakthroughs for M20x1.5 cable glands 2 breakthroughs for NPT 1/2" or Rigid Metallic Conduit
Weight	Approx. 1 kg

FM Control Drawing

Copying of this document and giving it to others and use or communication for the content, therefore, are forbidden without express authority.

Mittels dieser Verneinung dieser Hinweise, Verneinung und Hinweisdarstellung sind die Hersteller nicht haftbar für Schäden an den Anlagen.

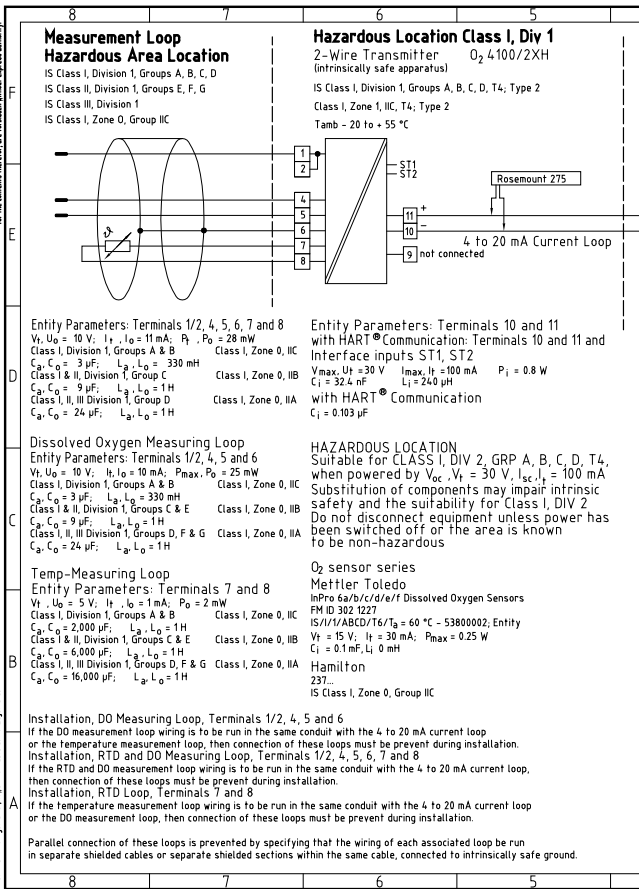

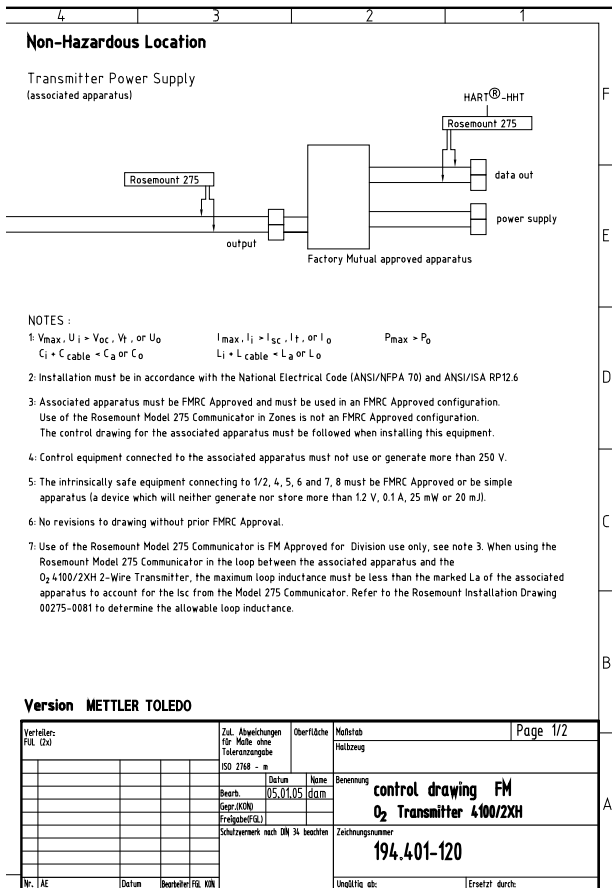

Explosion protection



Certificate of Compliance

Certificate: 1662790

Master Contract: 220331

Project: 1662790

Date Issued: May 18, 2005

Issued to: Mettler-Toledo GmbH
Im Hackacker 15
Urdorf, 8902
SWITZERLAND

Attention: Mr. Michael Haas

The products listed below are eligible to bear the CSA Mark shown



Issued by: K. Atkins

Authorized by: 
Nick Alfano
Operations Manager

PRODUCTS

CLASS 2258 04 - PROCESS CONTROL EQUIPMENT - Intrinsically Safe Entity - For Hazardous Locations

Class I, Division I, Groups A, B, C and D

Ex ib [ia] IIC

Transmitters Models 2100/2XH, 7100/2XH and Models 4100/2XH, input rated 30V, 4-20 mA, intrinsically safe devices provides intrinsically safe outputs to simple apparatus, pH, conductivity and oxygen probes when connected per control drawings 194.120-170, 194.220-190 and 194.320-190, 194.401-120. Maximum Ambient Temperature 55°C, Temperature Code T4.

For all models the input entity parameters are:

Terminals	Ui, Vmax	Ii, Imax	Pi, Pmax	Ci	Li
10, 11 or 14,15	30V	100mA	0.8W	32.4nF	0.24mH

Output entity parameters are:

2100/2XH

Warnings and notes to ensure safe operation

Warning: Do not disconnect equipment unless power has been switched off.

Warning: Clean only with antistatic moistened cloth.

Warning: Substitution of components may impair suitability for hazardous locations.

- The equipment shall be installed and protected from mechanical impact and ultraviolet (UV) sources.
- Clean only with a moistened antistatic cloth as potential electrostatic hazard may exist. Service equipment only with conductive clothing, footwear and personal grounding devices to prevent electrostatic accumulation.
- Internal grounding provisions shall be provided for field wiring. Bonding between conduit shall be provided during installation, and all exposed non-current carrying metallic parts shall be bonded and grounded.
- Installation in a Class I, Division 2 or Class I, Zone 2 hazardous location shall be in accordance with the Canadian Electrical Code (CEC Part 1) Section 18 Division 2 wiring methods.

OBSERVE THE SPECIFICATIONS OF THE CONTROL DRAWING!

CSA Control Drawing

Copying of this document and giving it to others and use or communication for the contents therefore, are forbidden without express authority.

Measurement Loop Hazardous Area Location

IS Class I, Division 1, Groups A, B, C, D
IS Class II, Division 1, Groups E, F, G
IS Class III, Division 1
IS Class I, Zone 0, Group IIC

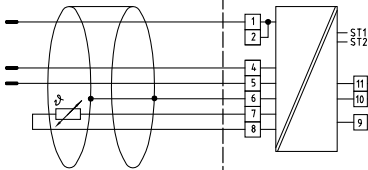

Hazardous Location Class I, Div 1

2-Wire Transmitter O₂ 4100/2XH
(intrinsically safe apparatus)
IS Class I, Division 1, Groups A, B, C, D, T4
EEx ib Iia) IIC T6 Tamb - 20 to + 55 °C; Type 2

O₂ sensor series

Mettler Toledo

InPro 6a/b/c/d/e/f Dissolved Oxygen Sensors

IS/1/1/ABCD/T6/T_A = 60 °C - 53800002; Entity
V_{max}, U_i = 15 V; I_{max}, I_i = 30 mA; P_{max}, P_i = 0.25 W
C_i = 0.1 μF, L_i 0 mH

Entity Parameters: Terminals 10/11
with HART® Communication: Terminals 10/11
Interface inputs ST1, ST2

V_{max}, U_i = 30 V I_{max}, I_i = 100 mA P_{max}, P_i = 800 mW
C_i = 32.4 nF L_i = 240 μH
with HART® Communication
C_i = 0.103 μF

HAZARDOUS LOCATION

Suitable for CLASS I, DIV 2, GRP A, B, C, D, T4,
when powered by V_{oc}, U_o = 30 V, I_{sc}, I_o = 100 mA
Substitution of components may impair intrinsic
safety and the suitability for Class I, DIV 2
Do not disconnect equipment unless power has been
switched off or the area is known to be non-hazardous

Oxygen Measuring Loop

Terminals	U _o , V _{sc}	I _o , I _{sc}	P _o	Co, Ca	Lo, La
1/2, 4, 5, 6					
IIC (GRP A, B)	10V	10mA	25mW	3μF	250mH
IIB (GRP C)	10V	10mA	25mW	9μF	1H
IIC (GRP D)	10V	10mA	25mW	24μF	1H

Temperature Measuring Loop

Terminals	U _o , V _{sc}	I _o , I _{sc}	P _o	Co, Ca	Lo, La
7, 8					
IIC (GRP A, B)	5V	1mA	2mW	100μF	1H
IIB (GRP C)	5V	1mA	2mW	300μF	1H
IIC (GRP D)	5V	1mA	2mW	800μF	1H

All Combined Outputs

Terminals	U _o , V _{sc}	I _o , I _{sc}	P _o	Co, Ca	Lo, La
1/2, 4, 5, 6, 7, 8					
IIC (GRP A, B)	10V	11mA	28mW	3μF	250mH
IIB (GRP C)	10V	11mA	28mW	9μF	1H
IIC (GRP D)	10V	11mA	28mW	24μF	1H

Weitergabe sowie Vervielfältigung dieses Überlage, Verwertung und Wiedergabe ihres Inhalts, nicht gestattet, soweit nicht ausdrücklich angegeben.

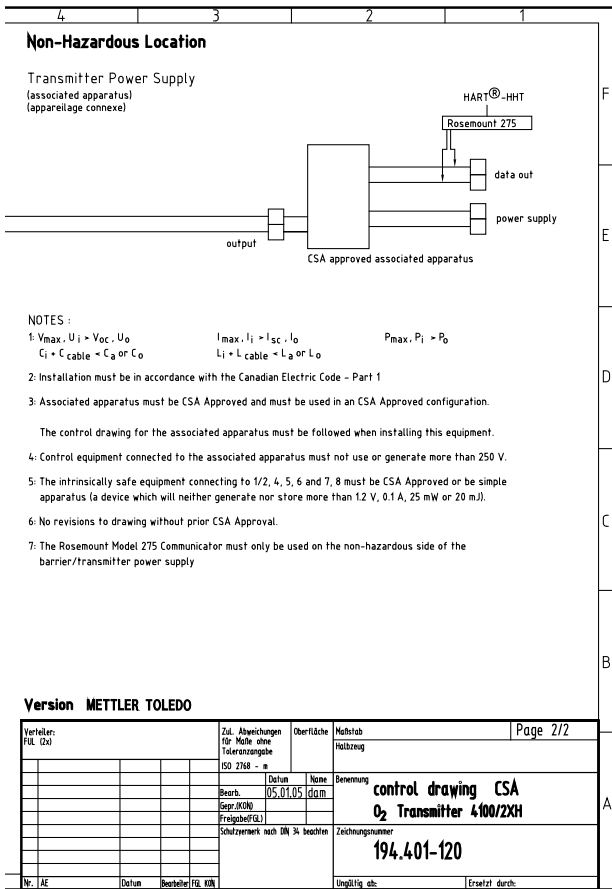

2-point calibration	61
22 mA signal for error message	49

A

Alarm	31
Alarm settings	56
Appendix	83
Assembly	14
Attenuation	47
Audit Trail	9

C

Calibration	61
Calibration to concentration (Conc)	64
Calibration to saturation (SAT)	62
Configuration	54
Display of calibration data	73
Product calibration	68
Temperature probe adjustment	72
Zero calibration	70
Cleaning	74
Configuration	34
Configuration steps	36
Configuration: Alarm settings	56
Alarm delay	57
LED in HOLD mode	57
Sensocheck	57
Configuration: Calibration mode	54
Cal timer interval	55
Configuration: Correction	52
Polarization voltage	53
Process pressure	53
Salinity correction	53

Index

Configuration: Current output	38
Current start / end	44
Output current during Error	48
Output signal during HOLD	49
Process medium	39
Process variable / unit	43
Sensor type	41
Temperature compensation	51
Time constant of output filter	47
Connection	18
Contents	3
Control Drawing	90, 94
CSA Control Drawing	94
Current source	74
Current start/end	45

D

Diagnostics functions	73, 74
Display of calibration data	73
Display of last error message	2, 73
Display of output current	73
Display of sensor current	73
Output current fixed	74
Display	27

E

EC Declaration of Conformity	8
EC-Type-Examination Certificate	2, 10
Error messages	76
Calibration error messages	78
Display of last error message	73
Explosion protection	87, 92
Cleaning in a hazardous location	6

F

FDA 21 CFR Part 11	9
FM Control Drawing	90

H

HART communication	31
Hold mode	30
Configuration	48
LED in HOLD mode	56
Output signal for HOLD	49

I

Installation	18, 94
Intended use	7

K

Keypad	28
--------------	----

L

Loop current	31
--------------------	----

M

Mounting plan	15
---------------------	----

O

Operating states	75
Output filter	46
Overview	2, 13

P

Package contents	14
Panel mounting	16

Index

Panel-mount kit	17
Parameter set - individual settings	37
Passcode editor	58
Pipe mounting	16
Pipe-mount kit	16
Polarization voltage	52
Power supply	6
Process pressure	52
Product calibration	68
Product line and accessories	83
Protective hood	16

S

Safety functions	29
Safety information	5
Installation	6
Salinity correction	52
Self test	29
Sensocheck	29, 81
ON / OFF	57
Sensoface	80
Calibration ranges	80
Specifications	84
Supply units	6

T

Temperature compensation	50
Temperature probe adjustment	72
Terminal assignments	19
Time constant of output filter	47

U

User interface	26
----------------	----

V, W

Volume concentration (Gas)	66
VP cable	24
Connection sensor/VP cable	24
Connection VP cable/meter	23
Connector assignment	25
Wiring examples	22
Sensors with connection via VP cable	23, 24, 25
Wiring examples	22

Z

Zero calibration	70
------------------------	----

BR **Mettler-Toledo Ind. e Com. Ltda.,**
Alameda Araguaia, 451 - Alphaville
BR - 06455-000 Barueri / SP, Brazil
Phone +55 11 4166 74 00
Fax +55 11 4166 74 01

CH **Mettler-Toledo (Schweiz) AG,**
Im Langacher,
CH- 8606 Greifensee, Switzerland
Phone +41 44 944 45 45
Fax +41 44 944 45 10

D **Mettler-Toledo GmbH,** Prozeßanalytik,
Ockerweg 3,
D - 35396 Gießen, Germany
Phone +49 641 507-333
Fax +49 641 507-397

F **Mettler-Toledo Analyse Industrielle Sàrl,**
30 Bld. de Douaumont, BP 949,
F - 75829 Paris Cedex 17, France
Phone +33 1 47 37 06 00
Fax +33 1 47 37 46 26

USA **Mettler-Toledo Ingold, Inc.,**
36 Middlesex Turnpike,
USA - Bedford, MA 01730, USA
Phone +1 781 301-88 00
Fax +1 781 271-06 81



Subject to technical changes.
© Mettler-Toledo GmbH, Process Analytics
06/05 Printed in Switzerland. 52 121 169

Mettler-Toledo GmbH, Process Analytics
Industrie Nord, CH-8902 Urdorf, Switzerland
Phone + 41 44 736 22 11, Fax +41 44 736 26 36

www.mtpro.com