

Timers



Selection Guide.....	792
RTE Series — Analog Timers	798
Accessories	803
Dimensions	804
GT3A Series — Analog Timers	805
GT3D — Digital Timers	813
GT3F Series — True OFF Delay Timers.....	826
GT3S (Star-Delta) Timers	831
GT3W Series — Dual Time Range Timers	834
GT3 Series.....	838
Accessories	838
Dimensions	842
GE1A Series — ON Delay Timers	844
Accessories	846
Dimensions	847
GT5P Series — ON Delay Timers.....	848
Accessories	851
Dimensions	852
GT5Y Series — ON Delay Timers.....	853
Accessories	856
Dimensions	857
General Instructions for All Timer Series ..	858



For more information on this product family, visit our website.





Additional resources include:

- New and updated product information
- Downloadable software demos & upgrades
- Part configuration tool & cross reference
- Online stock check & ordering
- IDEC field sales & distributor search
- Online literature request
- Downloadable manuals & CAD drawings
- Manufacturer's suggested retail price list
- Product training schedule & locations
- Advertising & trade show schedules
- Press releases & FAQs

www.idec.com/timer

Selection Guide

Selection Guide: RTE, GT3A, GT3D, and GT3F Series

Series Model	RTE	GT3A	GT3D	GT3F
Page	798	805	813	826
Appearance				
Mode of Operation	ON-delay Interval OFF-delay One-shot Cycle (ON first) Cycle (OFF first) Signal OFF delay Signal ON/OFF delay	ON-delay Interval OFF-delay One-shot Cycle (off first) Cycle (on first) Signal OFF delay Signal ON/OFF delay	ON-delay Interval One-shot One-shot ON delay Cycle Signal OFF delay Signal ON/OFF delay	True OFF-delay
Time Range	0.1 second to 600 hrs	0.1 second to 180 hrs	0.01 second to 99.9 hrs	0.1 to 600 seconds
Contact Configuration	DPDT	SPDT, DPDT	SPDT, DPDT	SPDT, DPDT
Repeat Accuracy	±0.25% maximum	±0.2% maximum	±0.3% maximum	±0.4% maximum
Contact Load Rating (resistive)	10A, 240V AC	SPDT: 3A, 250V AC DPDT: 5A, 240V AC	SPDT: 3A, 250V AC DPDT: 5A, 240V AC	5A, 250V AC
Available Operating Voltage	100-240V AC 12V DC 24V AC/DC	100 to 240V AC 12V DC 24V AC/DC	100 to 240V AC 24V AC/DC	100 to 240V AC 24V AC/DC
Approvals	UL Listed c-uL Listed TUV CE	UL Listed c-uL Listed CE	UL recognized TUV CSA CE	UL Listed c-uL Listed CE

- 1. For Timing Diagrams Overview, see page 794.
- 2. For all series specific instructions, accessories, and dimensions, see the individual series section.

Switches & Pilot Lights

Display Lights

Relays & Sockets





Timers

Terminal Blocks

Circuit Breakers

Selection Guide

Selection Guide: RTE, GT3A, GT3D, and GT3F Series

Series Model	GT3S	GT3W	GE1A	GT5P	GT5Y
Page	831	834	844	848	853
Appearance					
Mode of Operation	Star-Delta	Sequential start ON-delay Recycler and instantaneous Recycler OFF start Recycler ON start Interval Interval ON delay Sequential interval	ON-delay	ON-delay	ON-delay
Time Range	Star side: 0.05s to 100s Star-delta Switching Time: 0.05, 0.1, 0.25, 0.5 seconds	0.1s to 300 hrs	0.1s to 10 hrs	0.1s to 10 minutes	0.1s to 1 hour
Contact Configuration	SPST-NO	DPDT	SPDT, DPDT	SPDT	DPDT, 4PDT
Repeat Accuracy	±0.2% maximum	±0.2% maximum	±0.2% maximum	±0.2% maximum	±0.2% maximum
Contact Load Rating (resistive)	5A, 250V AC/30VDC	3A, 250V AC 5A, 120V AC/30V DC	5A, 240V AC	5A, 250V AC	5A, DPDT: 250V AC 3A, 4PDT: 250V AC
Available Operating Voltage	100 to 240V AC	100 to 240V AC 12V DC 24V AC/DC	24V AC/DC 110 to 120V AC 220 to 240V AC	100 to 120V AC 200 to 240V AC 12V DC 24V DC	100 to 120V AC 200 to 240V AC 12V DC 24V DC 24V AC
Approvals	UL Listed c-uL Listed CE	UL Listed c-uL Listed CE	UL Listed c-uL Listed TUV CE	UL recognized TUV CSA CE	UL Listed c-uL Listed CE

- 1. For Timing Diagrams Overview, see page 794..
- 2. For all series specific instructions, accessories, and dimensions, see the individual series section.

Switches & Pilot Lights

Display Lights

Relays & Sockets

Timers

Terminal Blocks

Circuit Breakers

Timing Diagrams Overview

Guide to Reading Timing Function Diagrams

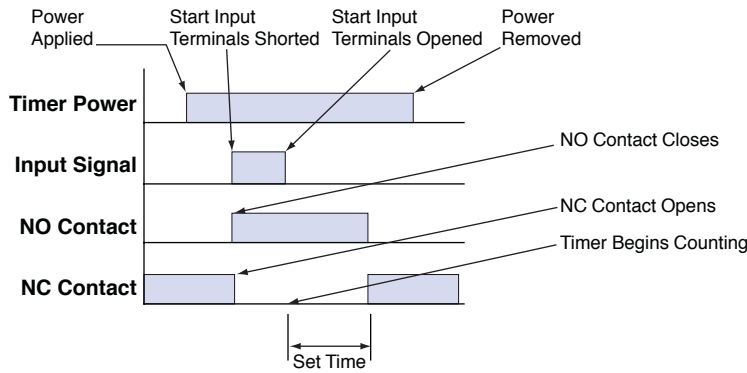

1. If power is disconnected during actual timing, most electronic timers reset to the preset time, ready for the re-application of supply voltage (except for GT3F "true OFF Delay").
2. NO = Normally open.
3. NC = Normally closed.

Timing Function Diagrams Overview

ON-Delay 1 (power start)

When voltage is applied to the coil, the relay contacts remain in the **off state** and the set time begins. When the set time has elapsed, the relay contacts transfer to the **on state**. The contacts remain in the on state until the timer is reset. The timer is reset by removing the coil voltage. Applicable models: RTE-P(B)1, GT3A-1, -2, -3, GT3D-1, -2, -3, -4, and GE1A.

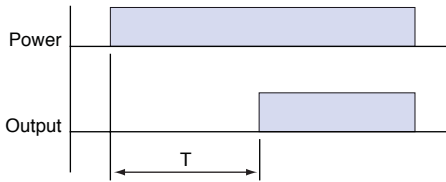

Type No.	GT3A-1, -2, -3	GT3D-1, -2, -3, -4	RTE-*1
Mode	A	1-A	A
See Page	805	813	798

Type No.	GE1A	GT5P	GT5Y
See Page	844	813	853

Interval 1 (power start)

When voltage is applied to the coil, the relay contacts transfer immediately to the **on state** and the set time begins. When the set time has elapsed, the relay contacts transfer to the **off state**. The contacts remain in the **off state** until the timer is reset. The timer is reset by removing the coil voltage. Applicable models: RTE-P(B)1, GT3A-1, -2, -3, and GT3D-1, -2, -3, -4.

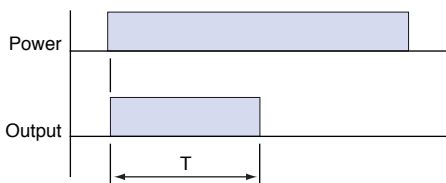

Type No.	GT3A-1, -2, -3	GT3D-1, -2, -3, -4	RTE-*1
Mode	B	1-B	B
See Page	805	813	798

ON-Delay 2 (signal start)

Voltage is applied to the coil at all times. When a start input is supplied, the relay contacts remain in the **off state** and the set time begins. When the set time has elapsed, the relay contacts transfer to the **on state**. The contacts remain in the **on state** until the timer is reset. The timer is reset by applying a reset input or by removing the coil voltage. Applicable models: GT3A-4, GT3D-4 and RTE-P(B) 2.

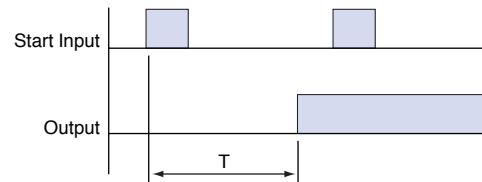

Type No.	GT3A-4	GT3D-4	RTE-*2
Mode	A	2-A	A
See Page	805	813	798

Interval 2 (signal start)

Voltage is applied to the coil at all times. When a start signal is supplied, the relay contacts transfer immediately to the **on state** and the set time begins. When the set time has elapsed, the relay contacts transfer to the **off state**. The contacts remain in the **off state** until the timer is reset. The timer is reset by applying a reset input or by removing the coil voltage. Applicable models: GT3A-5 and GT3D-4.

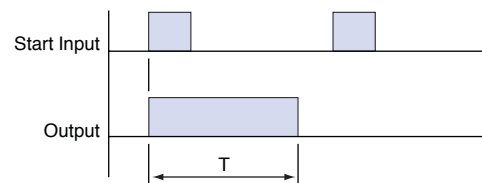

Type No.	GT3A-5	GT3D-4
Mode	A	2-E
See Page	805	813

1. T = set time, T' = shorter than set time, Ts = one shot output time
2. For more detailed timing diagrams, see specifications for individual timer models.

Cycle 1 (power start, OFF first)

When voltage is applied to the coil, the contacts remain in the **off state** and the set time begins. At the end of the set time, the contacts transfer to the **on state** and remain in the **on state** until the set time elapses. The timer cycles between the two states until power is removed from the coil. Removing the coil voltage resets the timer. The set time for both the **on state** and the **off state** is the same. Applicable models: GT3A-1, -2, -3, GT3D-1, -2, -3, -4 and RTE-P(B)1.

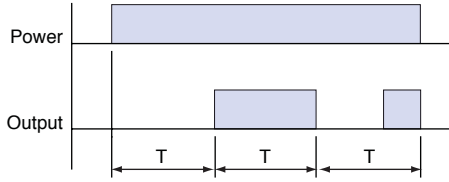

Type No.	GT3A-1, -2, -3	GT3D-1, -2, -3, -4	RTE-*1
Mode	C	1-C	C
See Page	805	813	798

Cycle 3 (power start, ON first)

When voltage is applied to the coil, the contacts immediately transfer to the **on state** and the set time begins. At the end of the set time, the contacts transfer to the **off state** and remain in the **off state** until the set time elapses. The timer cycles between the two states until power is removed from the coil. Removing the coil voltage resets the timer. The set time for both the **off state** and the **on state** is the same. Applicable models: GT3A-1, -2, -3, GT3D-1, -2, -3, -4 and RTE-P(B)1.

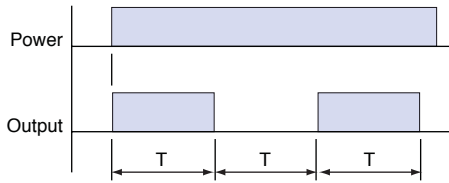

Type No.	GT3A-1, -2, -3	GT3D-1, -2, -3, -4	RTE-*1
Mode	D	1-D	D
See Page	805	813	798

One Shot 1 (signal start, retriggerable)

Voltage is applied to the coil at all times. When a start signal is supplied, the contacts immediately transfer to the **on state** and the set time begins. If another start signal is supplied (**before set time has elapsed**) the set time restarts, as the contacts remain in the **on state**. Successive pulses at a frequency greater than the set time will cause the contacts to remain in the **"On state"** indefinitely. When the set time has elapsed the contacts transfer back to the **off state**. The contacts remain in the **off state** until the next start signal is supplied (no reset is necessary). The timer can be reset by application of a reset input or by removing coil voltage. Applicable models: GT3A-6 and GT3D-4.

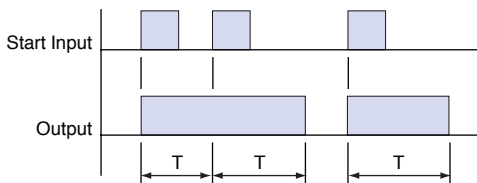

Type No.	GT3A-6	GT3D-4
Mode	A	3-C
See Page	805	813

Cycle 2 (signal start, OFF first)

Voltage is applied to the coil at all times. When a start signal is supplied, the relay contacts remain in the **off state** and the set time begins. At the end of the set time, the contacts transfer to the **on state** and remain in the **on state** until the set time elapses. The timer cycles between the two states until the timer is reset. The set time for both the **on state** and the **off state** are the same. The timer is reset by application of a reset input or by removing coil voltage. Applicable models: GT3A-4, GT3D-4 and RTE-P(B) 2.

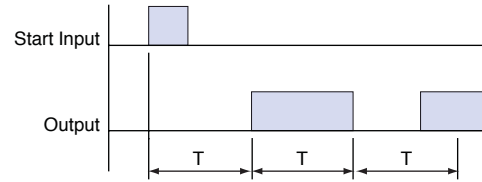

Type No.	GT3A-4	GT3D-4	RTE-*2
Mode	B	2-B	B
See Page	805	813	798

One Shot Cycle (signal start)

Voltage is applied to the coil at all times. When a start signal is supplied, the contacts remain in the **off state** and the set time begins. At the end of the set time, the contacts transfer to the **on state** and remain in the **on state** for the set time. After the set time has elapsed, the contacts return to the **off state**. The contacts remain in the **off state** until the timer is reset. The timer is reset by application of a reset input or by removing coil voltage. Applicable models: GT3A-5 and GT3D-4.

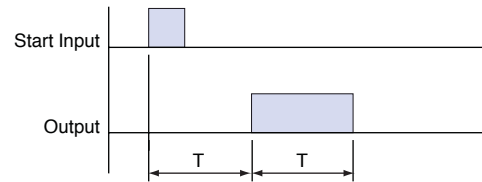

Type No.	GT3A-5	GT3D-4
Mode	B	2-F
See Page	805	813

One Shot 2 (signal start)

Voltage is applied to the coil at all times. When a start signal is supplied, the contacts immediately transfer to the **on state** and the set time begins. If another start signal is supplied (**before set time has elapsed**), the set time will not be affected. When the set time has elapsed, the contacts transfer back to the **off state**. The contacts remain in the **off state** until the next start signal is supplied (no reset is necessary). The timer can be reset by application of a reset input or by removing coil voltage. Applicable models: GT3A-6, GT3D-4, and RTE-P(B)2.

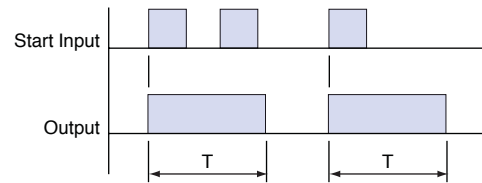

Type No.	GT3A-6	GT3D-4	RTE-*2
Mode	C	3-E	F
See Page	805	813	798

1. T = set time, T' = shorter than set time, Ts = one shot output time
 2. For more detailed timing diagrams, see specifications for individual timer models.

Signal ON/OFF-Delay 1

Voltage is supplied to the coil at all times. When a maintained start signal is supplied, the contacts immediately transfer to the **on state** and the set time begins. When the set time has elapsed, the contacts transfer to the **off state**. The contacts remain in the **off state** until the start signal is removed. The contacts transfer back to the **on state** and remain in the **on state** for the set time. When the set time has elapsed, the contacts transfer to the **off state** and remain in the **off state** until the start signal is supplied again (no reset is necessary). The timer is reset by application of a reset input or by removing coil voltage. Applicable models: GT3A-4, GT3D-4 and RTE-R(B)2.

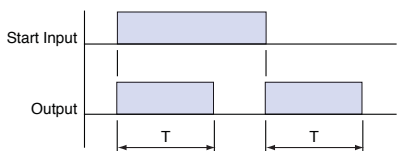

Type No.	GT3A-4	GT3D-4	RTE-*2
Mode	C	2-C	D
See Page	805	813	798

Signal ON/OFF-Delay 2

Signal ON/OFF-Delay 2

Voltage is supplied to the coil at all times. When a maintained start signal is supplied, the contacts remain in the **off state** and the set time begins. When the set time has elapsed, the contacts transfer to the **on state**. The contacts remain in the **on state** until the start signal is removed. Once the start signal is removed, the contacts remain in the **on state** and the set time begins again. Once the set time has elapsed, the contacts transfer back to the **off state**. The timer is ready for the next start signal. The timer is reset by the application of a reset signal or removal of power. Applicable models: GT3A-5 and GT3D-4.

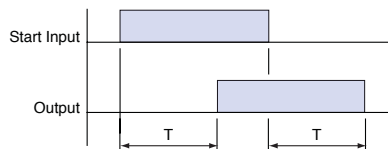

Type No.	GT3A-5	GT3D-4
Mode	C	3-A
See Page	805	813

Voltage is supplied to the coil at all times. When a momentary start signal is supplied, the contacts remain in the **off state** and the set time begins. When the set time has elapsed, the contacts transfer to the **on state**. The contacts remain in the **on state** until another momentary input is supplied. The contacts then remain in the **on state** for the set time. When the set time has elapsed, the contacts transfer to the **off state** and remain in the **off state** until the start signal is supplied again (no reset is necessary). The timer is reset by application of a reset input or by removing coil voltage. Applicable models: GT3A-6 and GT3D-4.

Signal OFF-Delay 1

Voltage is applied to the coil at all times. When a start signal is supplied, the contacts immediately transfer to the **on state**. The set time begins **when the start signal is removed**. When the set time has elapsed, the contacts transfer to the **off state**. The contacts remain in the **off state** until the next start signal is supplied (no reset is necessary). The timer can be reset by application of a reset input or by removing coil voltage. Applicable models: RTE-P(B)2, GT3A-4, and GT3D-4.

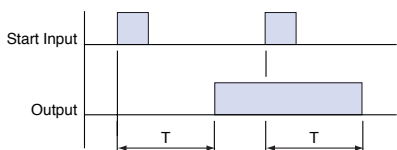

Type No.	GT3A-6	GT3D-4
Mode	D	3-F
See Page	805	813

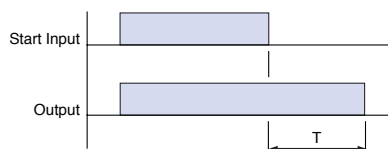

Type No.	GT3A-4	GT3D-4	RTE-*2
Mode	D	2-D	E
See Page	805	813	798

One Shot ON-Delay (signal start)

Signal OFF-Delay 2

When voltage is applied to the coil, the preset time is initiated and the contacts remain in the **off state** for the preset time. Following the preset time, the contacts transfer to the **on state**, and remain in the **on state** until the start input is supplied. Following the start input, the contacts transfer to the **off state** for the preset time. After the preset time has elapsed, the contacts transfer back to the **on state** and remain there until either the next start input is supplied or the timer is reset. The timer can be reset by either a reset input or removal of the coil voltage. Applicable models: GT3A-6 and GT3D-4.

Voltage is applied to the coil at all times. When a maintained start signal is supplied, the contacts remain in the **off state**. When the "start signal is removed", the contacts transfer to the "**On state**" and the set time begins. When the set time has elapsed, the contacts transfer back to the **off state**. They remain in the **off state** until the next start signal is supplied (no reset is necessary). The timer can be reset by application of a reset input or by removing coil voltage. Applicable models: GT3A-5 and GT3D-4.

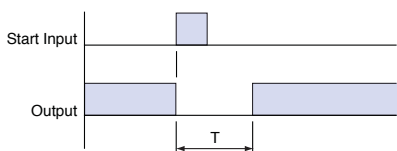

Type No.	GT3A-6	GT3D-4
Mode	B	3-D
See Page	805	813

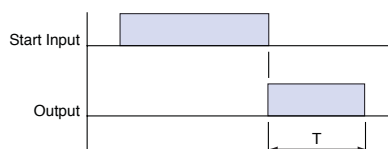

Type No.	GT3A-5	GT3D-4
Mode	D	3-B
See Page	805	813

1. T = set time, T' = shorter than set time, Ts = one shot output time
 2. For more detailed timing diagrams, see specifications for individual timer models.

ON-Delay One-Shot Output 1 (signal start)

Voltage is applied to the coil at all times. When a momentary start signal is supplied, the contacts remain in the off state and the preset time begins. Following the preset time, the contacts transfer to the on state and remain in the on state for the one-shot preset time. Following the one-shot preset time, the contacts transfer back to the off state and remain there until the timer is reset. The timer can be reset by applying either a reset input or removal of the coil voltage. Applicable model: GT3D-8.

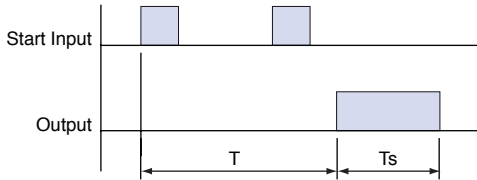

Type No.	GT3D-8
Mode	1
See Page	813

ON-Delay One-Shot Output 2 (signal start)

Voltage is applied to the coil at all times. When a maintained start signal is supplied, the contacts remain in the **off state** and the preset time begins. Following the preset time (start input is still present), the contacts transfer to the **on state** and remain in the **on state** for the one-shot preset time. When the one-shot preset time has elapsed, contacts transfer back to the **off state** and remain there until timer is reset. The timer can be reset by a reset input, removal of the coil voltage or removal of start input. Applicable model: GT3D-8.

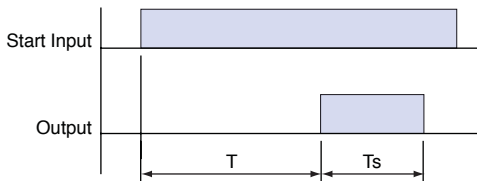

Type No.	GT3D-8
Mode	3
See Page	813

Sequential Start (power start)

When voltage is applied to the coil, both contacts remain in the OFF state and the set time, T1, begins. When T1 has elapsed, output 1 comes on and T2 begins. When T2 has elapsed, output 2 comes on. Both outputs remain on until power is removed from the coil. Applicable model: GT3W-A.

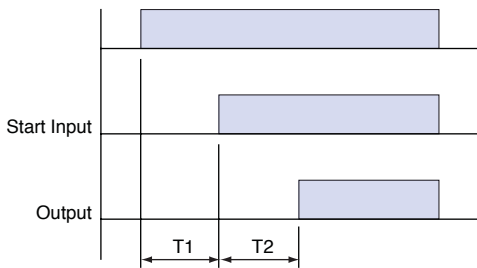

Type No.	GT3W-A
Mode	A
See Page	834

Cycle One-Shot Output (signal start)

Voltage is applied to the coil at all times. When a momentary start signal is supplied, the contacts remain in the **off state** and the preset time begins. Following the preset time, the contacts transfer to the **on state**. The contacts remain in the **on state** for the one-shot preset time. After the one-shot preset time has elapsed, the contacts transfer back to the **off state**. The contacts remain in the **off state** for the preset time minus the one-shot preset time. The timer cycles between **on and off states** until the timer is reset by a reset input or removal of the coil voltage. Applicable model: GT3D-8.

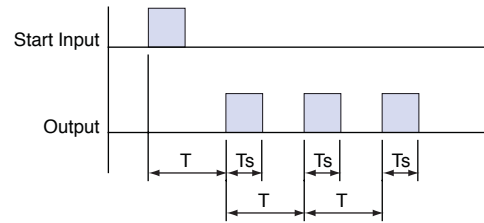

Type No.	GT3D-8
Mode	2
See Page	813

True Power-OFF Delay

When voltage is applied, output comes on immediately; when voltage is removed from the coil, the timer begins timing (internal capacitors power the timing circuit). When time has expired, contacts transfer back to the OFF state. If power is reapplied before the elapsed time has expired, the timing function will reset back to the starting point. Applicable models: GT3F-1, 2.

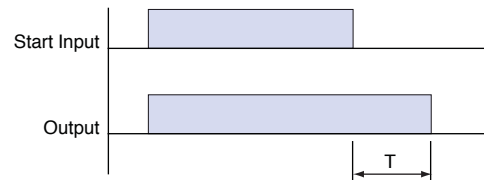

Type No.	GT3F-1, 2
Mode	Power OFF-Delay
See Page	826

Recycler Outputs (power start)

When voltage is applied to the coil, both contacts remain in the off state and time T1 begins. When T1 has elapsed, both contacts transfer to the ON state and T2 begins. When T2 has elapsed, both contacts transfer back to the OFF state and T1 begins again. The cycle continues until power is removed, at which time both contacts transfer back to the OFF state. Applicable model: GT3W-A.

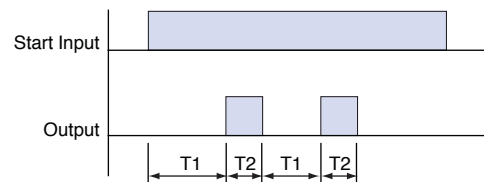

Type No.	GT3W-A
Mode	D
See Page	834

1. T = set time, T' = shorter than set time, Ts = one shot output time
 2. For more detailed timing diagrams, see specifications for individual timer models.

RTE Series – Analog Timers

Key features of the RTE series include:

- 20 time ranges and 10 timing functions
- Time delays up to 600 hours
- Space-saving package
- High repeat accuracy of ± 0.2%
- ON and timing OUT LED indicators
- Standard 8- or 11-pin and 11-blade termination
- 2 form C delayed output contacts
- 10A Contact Rating



Cert. No. E9950913332316 (EMC, RTE)
Cert. No. BL960813332355 (LVD, RTE)



UL Listed
File No. E66043



General Specifications

Operation System		Solid state CMOS Circuit	
Operation Type		Multi-Mode	
Time Range		0.1sec to 600 hours	
Pollution Degree		2 (IE60664-1)	
Over voltage category		III (IE60664-1)	
Rated Operational Voltage	AF20	100-240V AC(50/60Hz)	
	AD24	24V AC(50/60Hz)/24V DC	
	D12	12V DC	
Voltage Tolerance	AF20	85-264V AC(50/60Hz)	
	AD24	20.4-26.4V AC(50/60Hz)/21.6-26.4V DC	
	D12	10.8-13.2V DC	
Input off Voltage		Rated Voltage x10% minimum	
Ambient Operating Temperature		-20 to +65°C (without freezing)	
Ambient Storage and Transport Temperature		-30 to +75°C (without freezing)	
Relative Humidity		35 to 85%RH (without condensation)	
Atmospheric Pressure		80kPa to 110kPa (Operating), 70kPa to 110kPa (Transport)	
Reset Time		100msec maximum	
Repeat Error		±0.2%, ±20msec*	
Voltage Error		±0.2%, ±20msec*	
Temperature Error		±0.5%, ±20msec*	
Setting Error		±10% maximum	
Insulation Resistance		100MΩ minimum (500V DC)	
Dielectric Strength		Between power and output terminals: 2000V AC, 1 minute	
		Between contacts of different poles: 2000V AC, 1 minute	
		Between contacts of the same pole:1000V AC, 1 minute	
Vibration Resistance		10 to 55Hz amplitude 0.5mm ² hours in each of 3 axes	
Shock Resistance		Operating extremes: 98m/sec ² (10G) Damage limits: 490m/sec ² (50G) 3 times in each of 3 axes	
Degree of Protection		IP40 (enclosure) (IEC60529)	
Power Consumption (Approx.)	TYPE	RTE-P1, -B1	RTE-P2, -B2
		AF20	
	120V AC/60Hz	6.5VA	6.6VA
	240V AC/60Hz	11.6VA	11.6VA
24V AC 60Hz/DC	3.4VA/1.7W	3.5VA/1.7W	
D12	1.6W	1.6W	
Mounting Position		Free	
Dimensions	RTE-P1, P2	40Hx 36W x 77.9D mm	
	RTE-B1, B2	40Hx 36W x 74.9D mm	
Weight (Approx.)	RTE-P1	RTE-P2	RTE-B1, -B2
	87g	89g	85g

Contact Ratings

Contact Configuration	2 Form C, DPDT (Delay output)	
Allowable Voltage / Allowable Current	240V AC, 30V DC / 10A	
Maximum Permissible Operating Frequency	1800 cycles per hour	
Rated Load	Resistive	10A 240V AC, 30V DC
	Inductive	7A 240V AC, 30V DC
	Horse Power Rating	1/6 HP 120V AC, 1/3 HP 240V AC
Life	Electrical	500,000 op. minimum (Resistive)
	Mechanical	50,000,000 op. minimum



*For the value of the error against a preset time, whichever the largest. applies.

Switches & Pilot Lights

Display Lights

Relays & Sockets

Timers

Terminal Blocks

Circuit Breakers

Part Numbering Guide

RTE series part numbers are composed of 4 part number codes. When ordering a RTE series part, select one code from each category.
Example: **RTE-P1AF20**

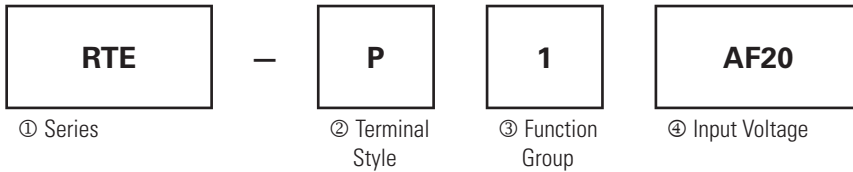

Part Numbers: RTE Series

	Description	Part Number Code	Remarks
① Series	RTE series	RTE	For internal circuits, see next page.
② Terminal Style	Pin	P	Select one only.
	Blade	B	
③ Function Group	ON-delay, interval, cycle OFF, cycle ON	1	Each function group has different timing functions.
	ON-delay, cycle OFF, cycle ON, signal ON/OFF delay, OFF-delay, one-shot	2	See page 794.
④ Input Voltage	100 to 240V AC(50/60Hz)	AF20	
	24V AC(50/60Hz)/24V DC	AD24	
	12V DC	D12	

Part Numbers

Voltage	Power Triggered		Start Input Triggered	
	8-Pin	Blade	11-Pin	Blade
12V DC	RTE-P1D12	RTE-B1D12	RTE-P2D12	RTE-B2D12
24V AC/DC	RTE-P1AD24	RTE-B1AD24	RTE-P2AD24	RTE-B2AD24
100-240V AC	RTE-P1AF20	RTE-B1AF20	RTE-P2AF20	RTE-B2AF20

Time Range Determined by Time Range Selector and Dial Selector

	Dial	0 - 1	0 - 3	0 - 10	0 - 30	0 - 60
Range	Second	0.1 sec - 1 sec	0.1 sec - 3 sec	0.2 sec - 10 sec	0.6 sec - 30 sec	1.2 sec - 60 sec
	Minute	1.2 sec - 1 min	3.6 sec - 3 min	12 sec - 10 min	36 sec - 30 min	1.2 min - 60 min
	Hour	1.2 min - 1 hr	3.6 min - 3 hr	12 min - 10 hr	36 min - 30 hr	1.2 hr - 60 hr
	10 Hours	12 min - 10 hr	36 min - 30 hr	2 hr - 100 hr	6 hr - 300 hr	12 hr - 600 hr

Timing Diagrams

RTE-P1, -B1

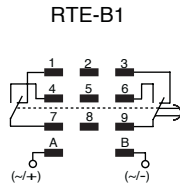
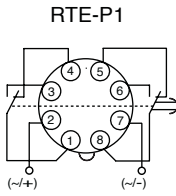

1. RTE-B1: Do not apply voltage to terminals #2, #5 & #8.
2. IDEC sockets are as follows: RTE-P1: SR2P-06* pin type socket, RTE-B1: SR3B-05* blade type socket, (*-may be followed by suffix letter A,B,C or U).

A: ON-Delay 1 (power start)

Set timer for desired delay, apply power to coil. Contacts transfer after preset time has elapsed, and remain in transferred position until timer is reset. Reset occurs with removal of power.

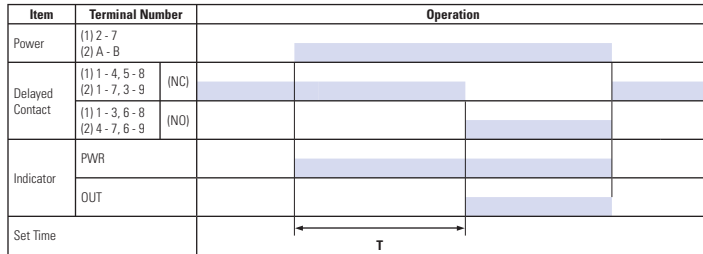

B: Interval (power start)

Set timer for desired delay, apply power to coil. Contacts transfer immediately, and return to original position after preset time has elapsed. Reset occurs with removal of power.

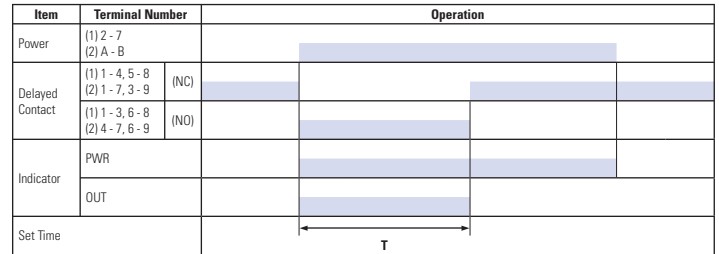

C: Cycle 1 (power start, OFF first)

Set timer for desired delay, apply power to coil. First transfer of contacts occurs after preset delay has elapsed, after the next elapse of preset delay contacts return to original position. The timer now cycles between on and off as long as power is applied (duty ratio 1:1).

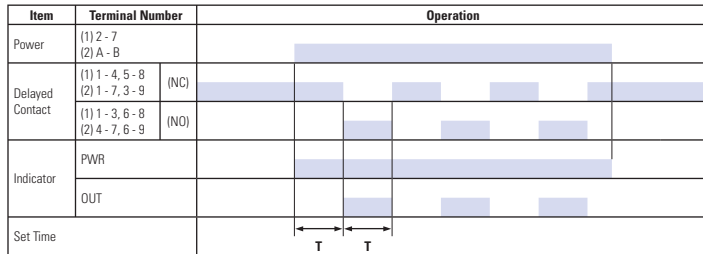

C: Cycle 3 (power start, ON first)

Functions in same manner as Mode C, with the exception that first transfer of contacts occurs as soon as power is applied. The ratio is 1:1. Time On = Time Off

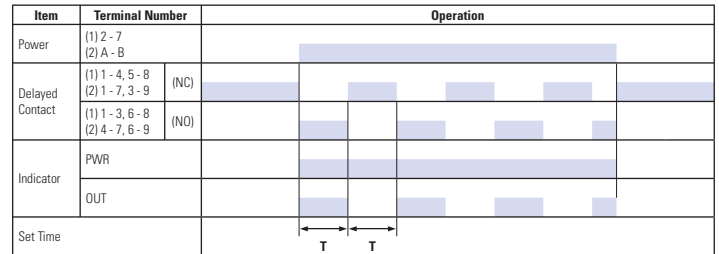

Timing Diagrams con't

RTE-P2, -B2

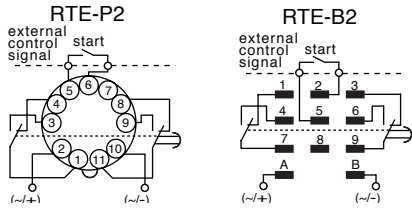

1. RTE-P2: Do not apply voltage to terminals #5, #6 & #7.
2. RTE-B2: Do not apply voltage to terminals #2, #5 & #8.
3. IDEC sockets are as follows: RTE-P2: SR3P-05* pin type socket, RTE-B2: SR3B-05* blade type socket, (*-may be followed by suffix letter A,B,C or U).

A: ON-Delay 2 (signal start)

When a preset time has elapsed after the start input turned on while power is on, the NO output contact goes on.

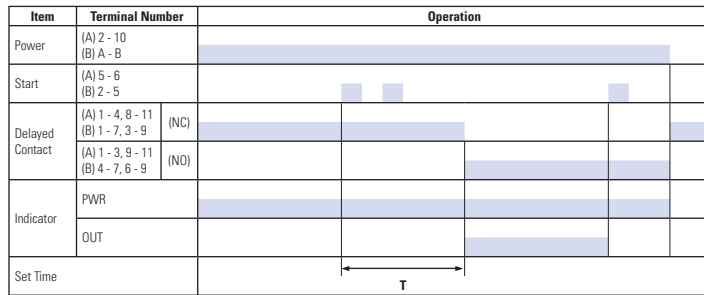

B: Cycle 2 (signal start, OFF first)

When the start input turns on while power is on, the output oscillates at a preset cycle (duty ratio 1:1), starting while the NO contact off.

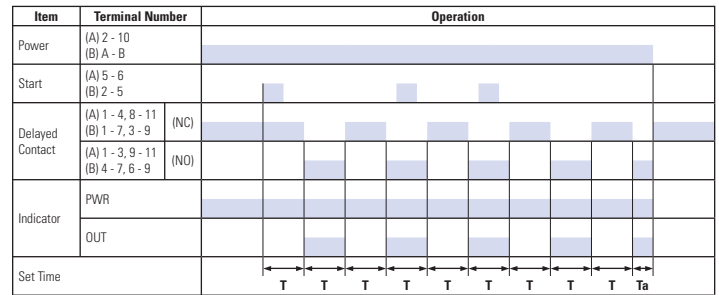

C: Cycle 4 (signal start, ON first)

When the start input turns on while power is on, the NO contact goes on. The output oscillates at a preset cycle (duty ratio 1:1).

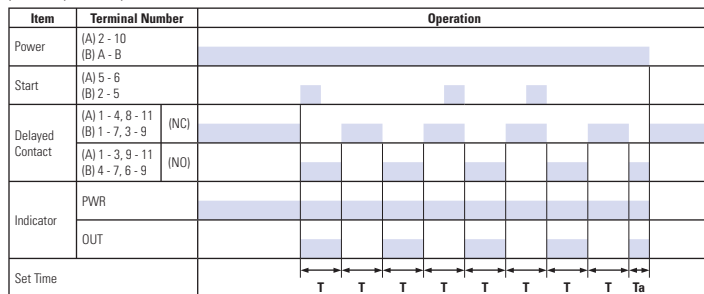

D: Signal ON/OFF-Delay

When the start input turns on while power is on, the NO output contact goes on. When a preset time has elapsed while the start input remains on, the output contact goes off. When the start input turns off, the NO contact goes on again. When a preset time has elapsed after the start input turned off, the NO contact goes off.

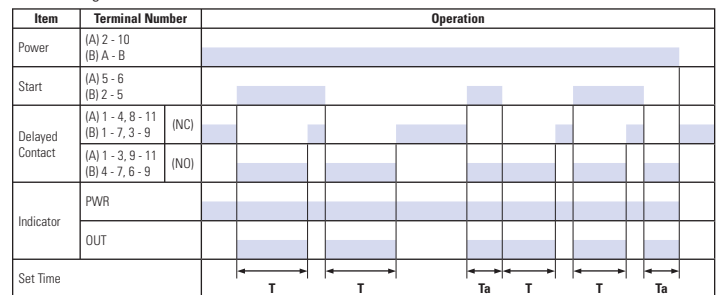

E: Signal OFF-Delay

When power is turned on while the start input is on, the NO output contact goes on. When a preset time has elapsed after the start input turned off, the NO output contact goes off.

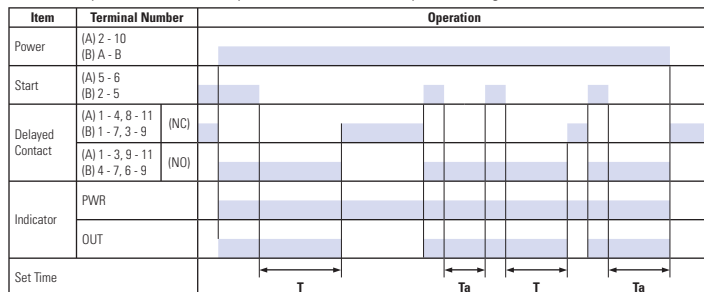

F: One-Shot (signal start)

When the start input turns on while power is on, the NO output contact goes on. When a preset time has elapsed, the NO output contact goes off.

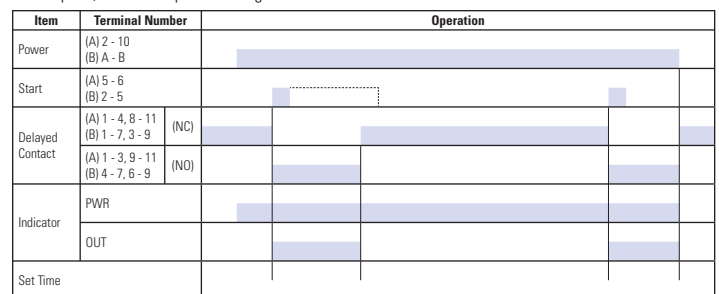

Temperature Derating Curves

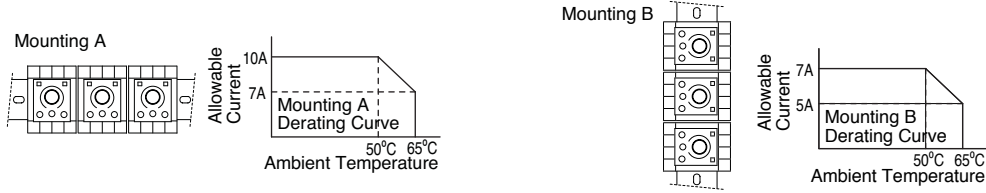

Instructions

Installation of Hold-Down Springs DIN Rail Mount Socket

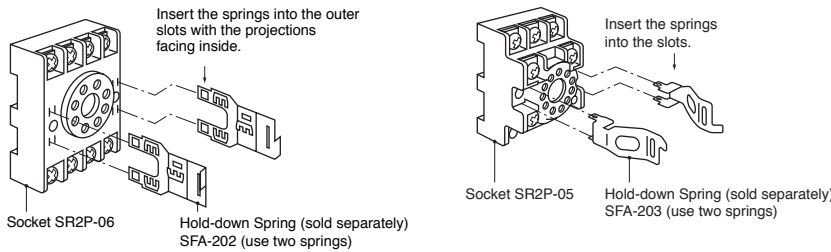

Switch Settings

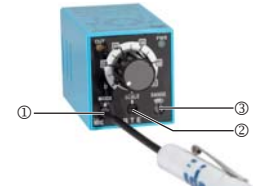

- ① Operator Mode Selector
- ② Scale Selector
- ③ Time Range Selector

1. Turn the selectors securely using a flat screwdriver 4mm wide (maximum). Note that incorrect setting may cause malfunction. Do not turn the selectors beyond their limits.
2. Since changing the setting during timer operation may cause malfunction, turn power off before changing.

Safety Precautions

Special expertise is required to use Electronic Timers.

- All Electronic Timers are manufactured under IDEC's rigorous quality control system, but users must add a backup or fail safe provision to the control system when using the Electronic Timer in applications where heavy damage or personal injury may occur should the Electronic Timer fail.
- Install the Electronic Timer according to instructions described in this catalog.
- Make sure that the operating conditions are as described in the specifications. If you are uncertain about the specifications, contact IDEC in advance.
- In these directions, safety precautions are categorized in order of importance under Warning and Caution.

Warnings

Warning notices are used to emphasize that improper operation may cause severe personal injury or death.

- Turn power off to the Electronic timer before starting installation, removal, wiring, maintenance, and inspection on the Electronic Timer.
- Failure to turn power off may cause electrical shocks or fire hazard.

- Do not use the Electronic Timer for an **emergency stop circuit** or **interlocking circuit**. If the Electronic Timer should fail, a machine malfunction, breakdown, or accident may occur.

Caution

Caution notices are used where inattention might cause personal injury or damage to equipment.

- The Electronic Timer is designed for installation in equipment. Do not install the Electronic Timer outside equipment.
- Install the Electronic Timer in environments described in the specifications. If the Electronic Timer is used in places where it will be subjected to high-temperature, high-humidity, condensation, corrosive gases, excessive vibrations, or excessive shocks, then electrical shocks, fire hazard, or malfunction could result.
- Use an IEC60127-approved fuse and circuit breaker on the power and output line outside the Electronic Timer.
- Do not disassemble, repair, or modify the Electronic Timer.
- When disposing of the Electronic Timer, do so as industrial waste.

Accessories

DIN Rail Mounting Accessories

DIN Rail/Surface Mount Sockets and Hold-Down Springs

DIN Rail Mount Socket				Applicable Hold-Down Springs	
Style	Appearance	Use with Timers	Part Number	Appearance	Part Number
11-Pin Screw Terminal (dual tier)		RTE-P2	SR3P-05		SFA-203
11-Pin FingerSafe Socket		RTE-P2	SR3P-05C		
8-Pin Screw Terminal		RTE-P1	SR2P-06		SFA-202
8-Pin Fingersafe Socket			SR2P-05C		
11-Blade Screw Terminal		RTE-B1 RTE-B2	SR3B-05		
DIN Mounting Rail Length 1000mm		—	BNDN1000		

Switches & Pilot Lights

Display Lights

Relays & Sockets

Timers

Terminal Blocks

Circuit Breakers

Panel Mounting Accessories

Flush Panel Mount Adapter and Sockets that use an Adapter

Accessory	Description	Appearance	Use with	Part No.
Panel Mount Adapter	Adaptor for flush panel mounting RTE timers		All RTE timers	RTB-G01
Sockets for use with Panel Mount Adapter	8-pin screw terminal		RTE-P1	SR6P-M08G
	11-pin screw terminal		RTE-P2	SR6P-M11G
	8-pin solder terminal		RTE-P1	SR6P-S08
	11-pin solder terminal		RTE-P2	SR6P-S11

Dimensions

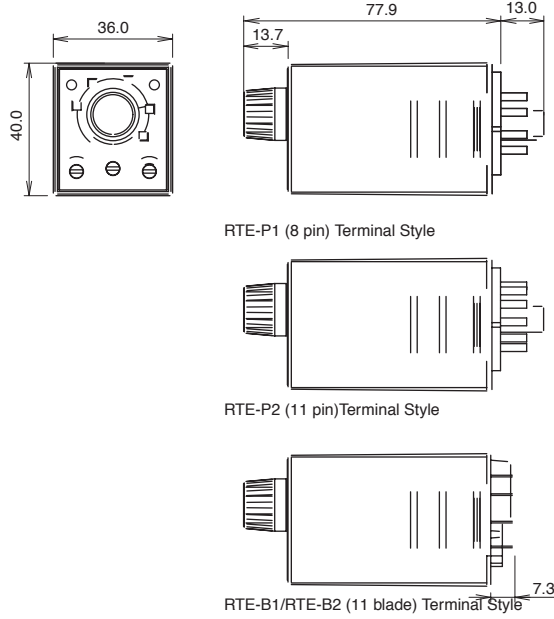

Panel Mount Adapter

RTE Timer, 8-Pin and 11-Pin with SR6P-S08 or SR6P-S11

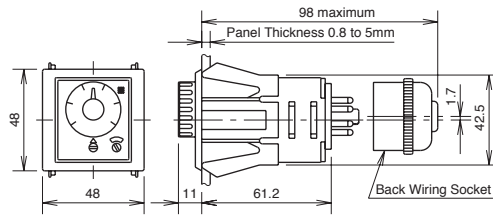

RTE Timer, 8-Pin with SR6P-M08G

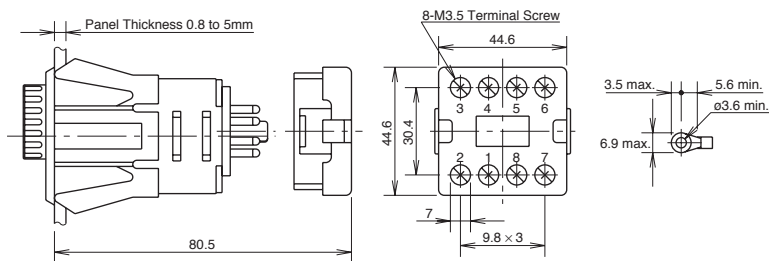

RTE Timer, 11-Pin with SR6P-M11G

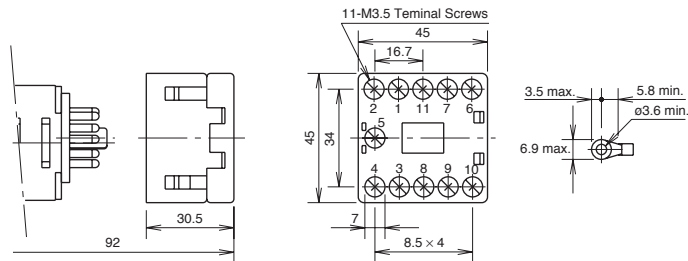

GT3A Series – Analog Timers

Key features of the GT3A series include:

- 4 selectable operation modes on each model
- External start, reset, and pause inputs
- Panel mount or socket mount
- Large variety of timing functions
- Power and output status indicating LEDs



Specifications

	GT3A-1	GT3A-2	GT3A-3	GT3A-4,-5,-6
Operation	Multi-mode			Multi-mode with inputs (11 pins)
Time Range	0.1s to 180 hours			
Rated Voltage	100 to 240V AC, 50/60Hz 12V DC 24V AC, 50/60Hz / 24V DC			
Contact Ratings	125V AC/250V AC, 3A; 30V DC, 1A (resistive load)		125V AC/250V AC, 5A; 30V DC, 5A (resistive load)	
Minimum Applicable Load	5V, 10mA (reference value)			
Voltage Tolerance	AF20 (100V AC): 85 to 264V AC AD24: 20.4 to 26.4V AC/21.6 to 26.4V DC D12: 10.8 to 13.2V DC			
Error	±0.2%, ±10 msec (repeat, voltage, temperature)			
Setting Error	±10% maximum			
Reset Time	60msec maximum			
Insulation Resistance	100MW minimum			
Dielectric Strength	Between power and output terminals: 2,000V AC, 1 minute Between contacts of different poles: 2,000V AC, 1 minute Between contacts of the same pole: 750V AC, 1 minute			
Power Consumption (approximate)	Delayed SPDT	Delayed SPDT + instantaneous SPDT	Delayed DPDT	Delayed DPDT
	10.8VA (200V AC, 60Hz)	13.5VA (200V AC, 60Hz)	14.4VA (200V AC, 60Hz)	4.7VA (100V AC, 60Hz), 14.4VA (200V AC, 60Hz)
	—	12VDC/1W 24VDC/0.7W 24VAC/1.2VA	12VDC/1.1W 24VDC/0.6W 24VAC/1.3VA	12VDC/0.8W 24VDC/0.6W 24VAC/1.3VA
Mechanical Life	10,000,000 operations minimum		5,000,000 operations minimum	
Electrical Life	50,000 operations minimum (rated load)		100,000 operations minimum (rated load)	
Weight (approximate)	63g	73g	79g	80g
Vibration Resistance	100m/sec ² (approximate 10G)			
Shock Resistance	Operating extremes: 100m/sec ² (approximate 10G) Damage limits: 500m/sec ² (approximate 50G)			
Operating Temperature	-10 to +50°C			
Operating Humidity	45 to 85% RH			
Storage Temperature	-30 to +80°C			
Housing Color	Gray			

Part Numbers
GT3A-1, -2, -3

Mode Of Operation	Rated Voltage Code	Time Range	Output	Contact	Complete Part No.	
					8-Pin	11-Pin
A: ON-delay 1 B: Interval 1 C: Cycle 1 D: Cycle 3	AF20: 100 to 240V AC (50/60Hz)	0.1 seconds to 180 hours	250V AC, 3A, 30V DC, 1A (resistive load)	Delayed SPDT	GT3A-1AF20	GT3A-1EAF20
	AF20: 100 to 240V AC (50/60Hz) D12: 12V DC AD24: 24V AC (50/60Hz)/24V DC				Delayed SPDT + Instantaneous SPDT	GT3A-2AF20
				Delayed DPDT		GT3A-2D12
					Delayed DPDT	GT3A-2AD24
				Delayed DPDT		GT3A-3AF20
	Delayed DPDT				GT3A-3D12	GT3A-3ED12
Delayed DPDT		GT3A-3AD24	GT3A-3EAD24			

-
1. For wiring schematics and timing diagrams for GT3A-1, -2, -3, see pages 807 and 808 respectively.
 2. For more details about time ranges, see instructions on page 812.
 3. For socket and accessory part numbers, see page 838.

GT3A-4, -5, -6

Mode of Operation	Rated Voltage Code	Time Range	Output	Contact	Input	Complete Part No.	
						A (11-pin)	B (11-pin)
A: ON-Delay 2 B: Cycle 2 C: Signal ON/OFF-Delay 1 D: Signal OFF-Delay 1	AF20: 100 to 240V AC (50/60Hz) D12: 12V DC AD24: 24V AC (50/60Hz)/24V DC	0.1 seconds to 180 hours	250V AC, 5A, 24V DC, 5A (resistive load)	Delayed DPDT	Start Reset Gate	GT3A-4AF20	GT3A-4EAF20
						GT3A-4D12	GT3A-4ED12
						GT3A-4AD24	GT3A-4EAD24
A: Interval 2 B: One-Shot Cycle C: Signal ON/OFF-Delay 2 D: Signal OFF-Delay 2	AF20: 100 to 240V AC (50/60Hz) AD24: 24V AC (50/60Hz)/24V DC	0.1 seconds to 180 hours	250V AC, 5A, 24V DC, 5A (resistive load)	Delayed DPDT	Start Reset Gate	GT3A-5AF20	GT3A-5EAF20
						GT3A-5AD24	GT3A-5EAD24
A: One-Shot B: One-Shot ON-Delay C: One-Shot 2 D: Signal ON/OFF-Delay 3	AF20: 100 to 240V AC (50/60Hz) AD24: 24V AC (50/60Hz)/24V DC	0.1 seconds to 180 hours	250V AC, 5A, 24V DC, 5A (resistive load)	Delayed DPDT	Start Reset Gate	GT3A-6AF20	GT3A-6EAF20
						GT3A-6AD24	GT3A-6EAD24

-
4. For wiring schematics and timing diagrams GT3A-4,-5,-6, see pages 809, 810, and 811 respectively.
 5. For more details about time ranges, see instructions on page 812.
 6. A (11-pin) and B (11-pin) differ in the way inputs are wired.
 7. For socket and accessory part numbers, see page 838.
 8. For the timing diagrams overview, see page 794.

Switches & Pilot Lights

Display Lights

Relays & Sockets

Timers

Terminal Blocks

Circuit Breakers

Timing Diagrams/Schematics

GT3A-1 Timing Diagrams
Delayed SPDT

Operation
Mode
Selection

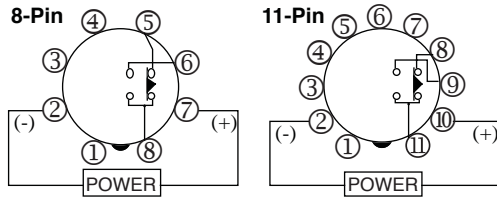

ON-Delay 1

MODE

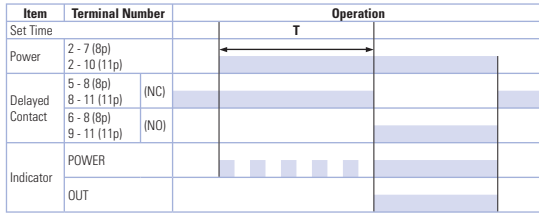

Interval 1

MODE

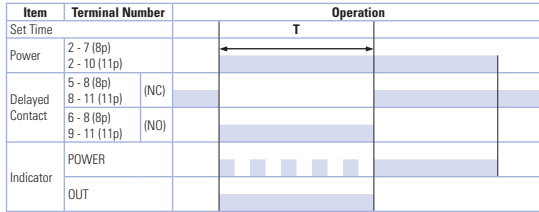

Cycle 1

(OFF first)

MODE

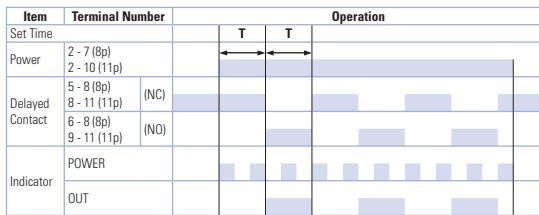

Cycle 3

(ON first)

MODE

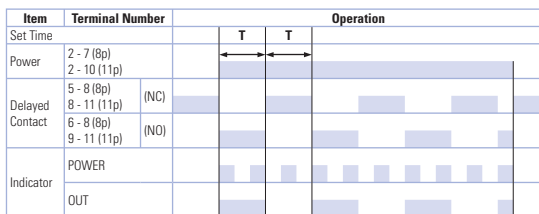

GT3A-2 Timing Diagrams
Delayed SPDT + Instantaneous SPDT

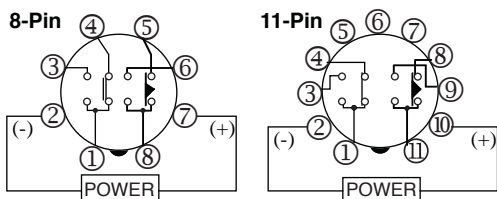

Operation Mode Selection

ON-Delay 1

MODE

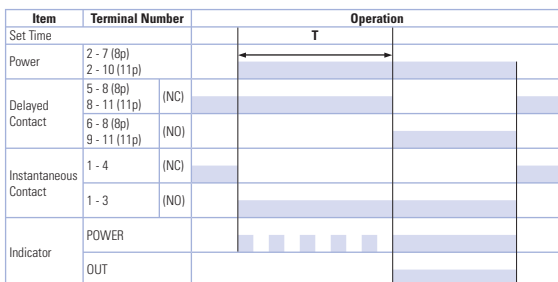

Interval 1

MODE

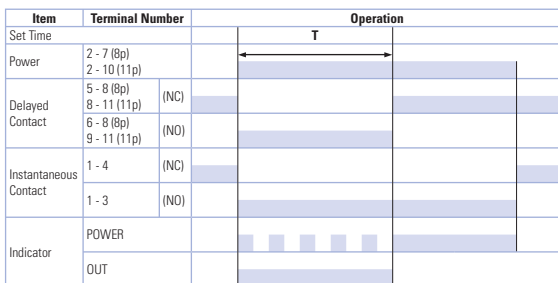

Cycle 1 (OFF first)

MODE

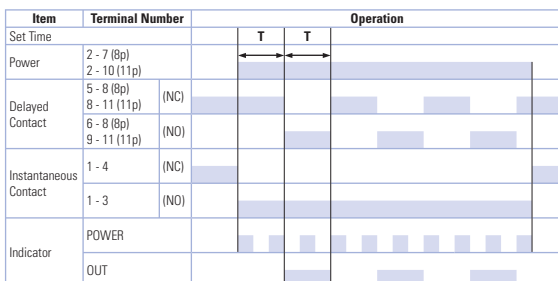

GT3A-3 Timing Diagrams
Delayed DPDT

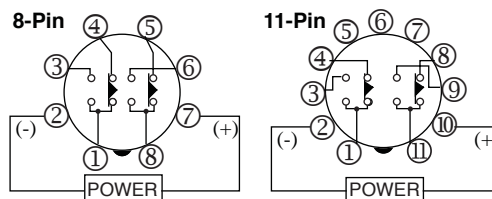

Operation Mode Selection

ON-Delay 1

MODE

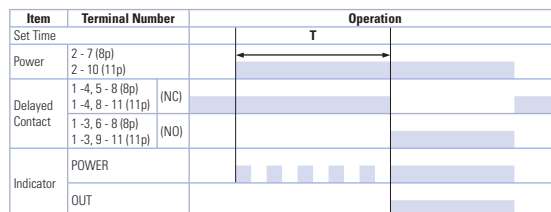

Interval 1

MODE

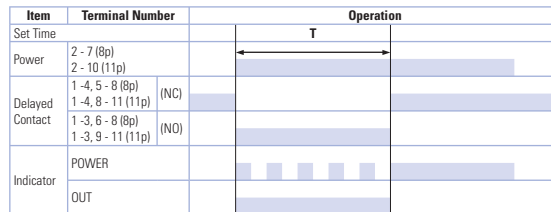

Cycle 1 (OFF first)

MODE

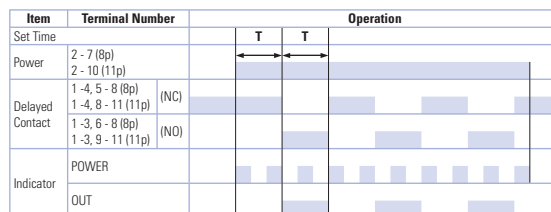

Cycle 3 (ON first)

MODE

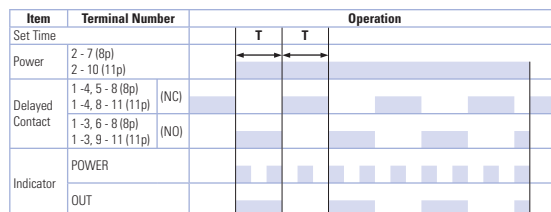

Switches & Pilot Lights

Display Lights

Relays & Sockets

Timers

Terminal Blocks

Circuit Breakers

GT3A-4 Timing Diagrams
Delayed DPDT

Operation
Mode Selection

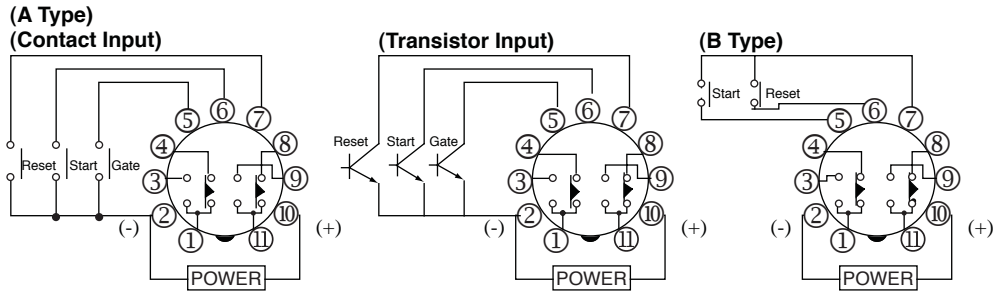

ON-Delay 2

MODE

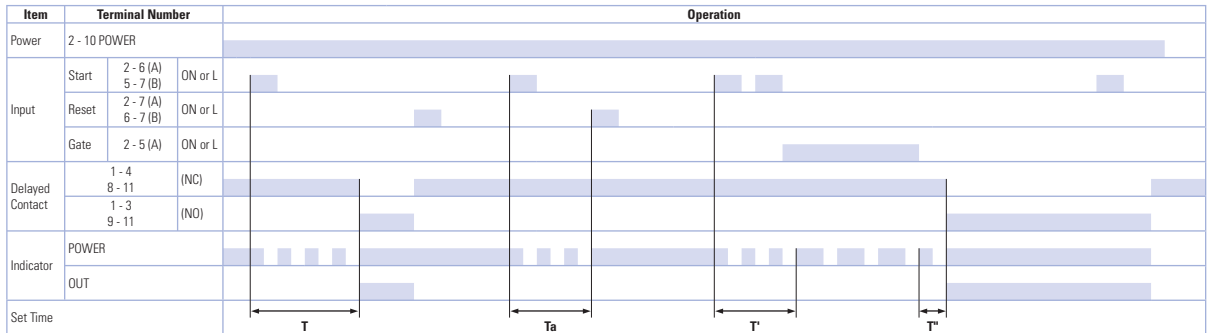

Cycle 2

MODE

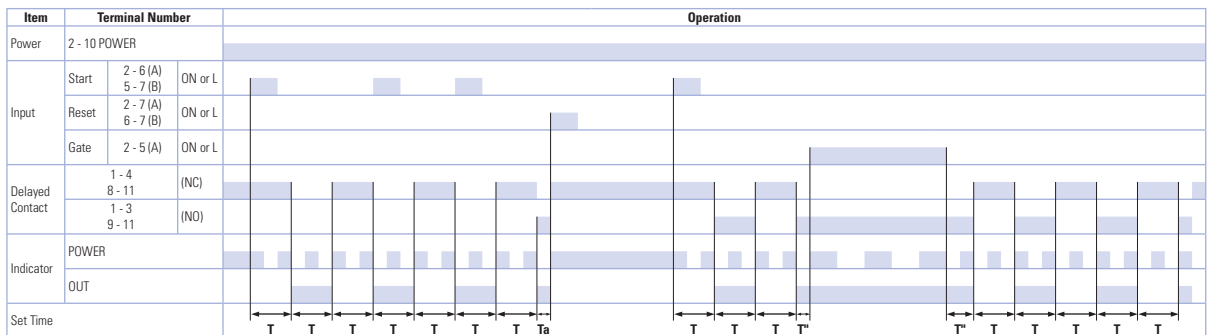

Signal ON/OFF-Delay 1

MODE

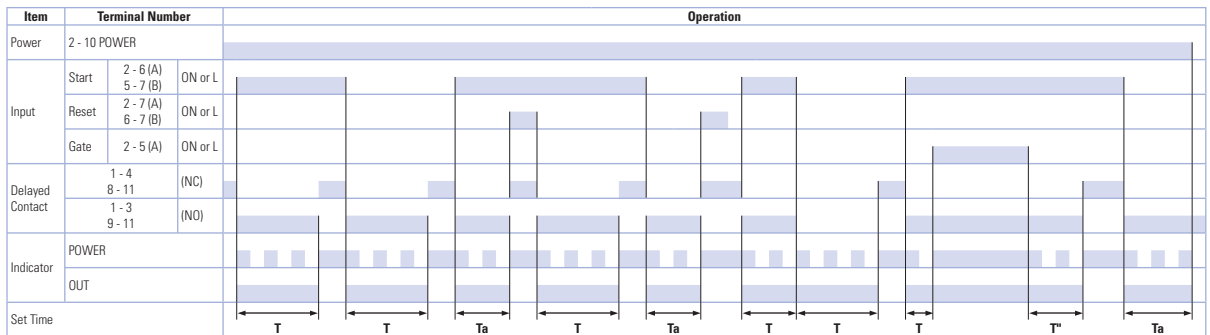

Signal OFF-Delay 1

MODE

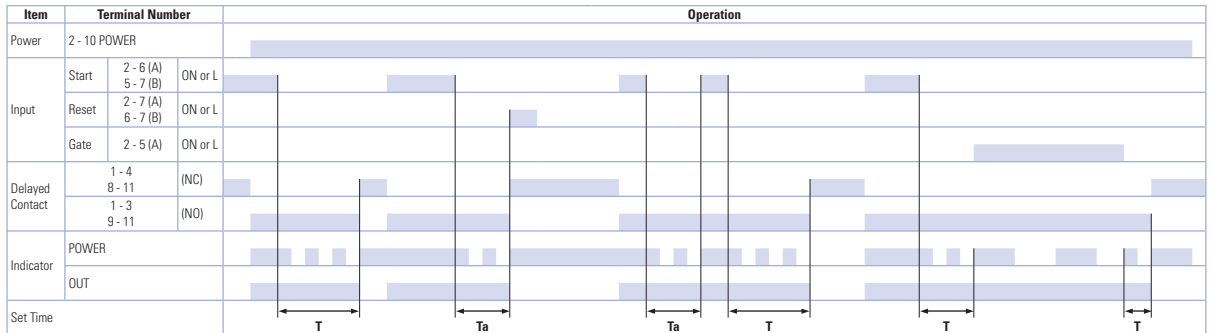

T = Set time Ta = Shorter than set time
T = T' + T''

GT3A-5 Timing Diagrams
Delayed DPDT

Operation
Mode Selection

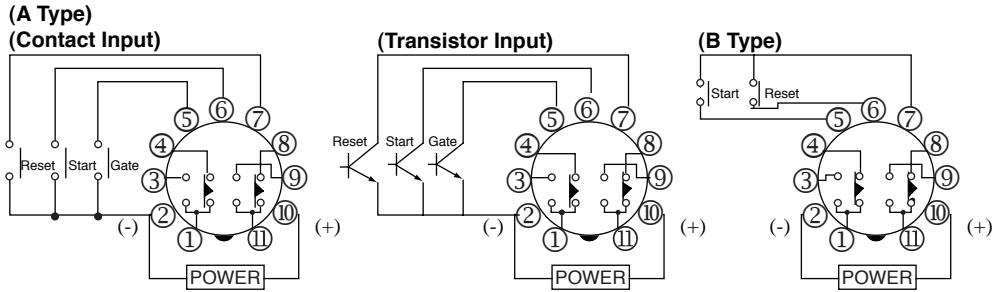

Interval 2

MODE

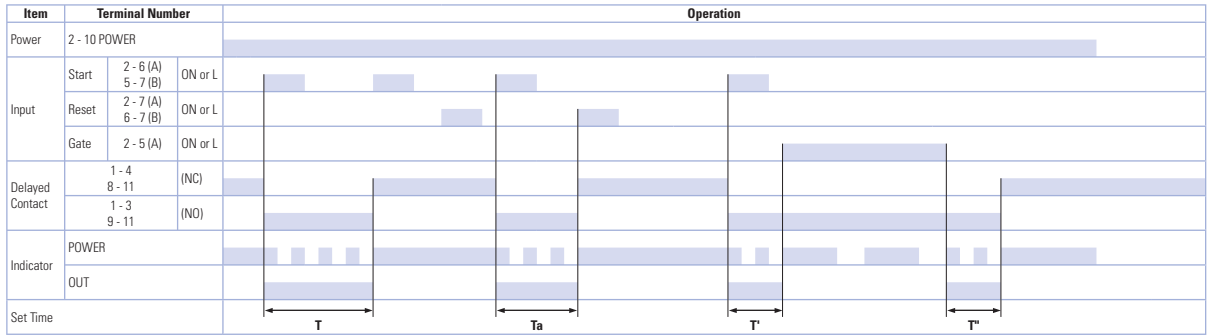

One-Shot Cycle

MODE

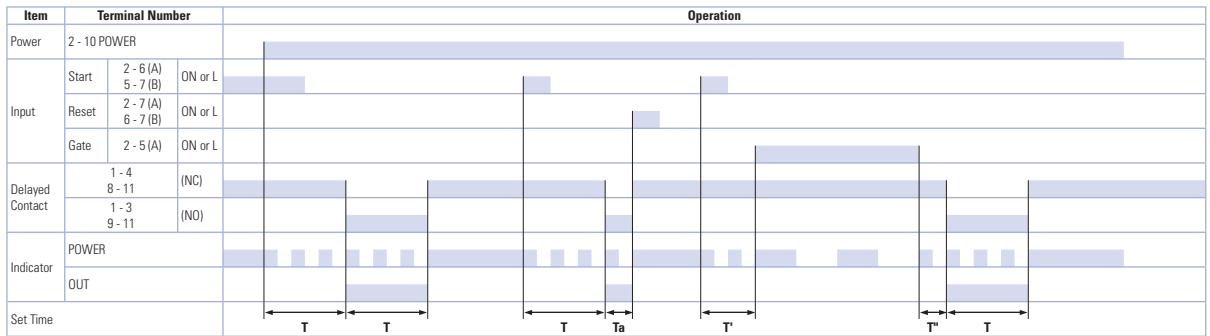

Signal ON/OFF-Delay 2

MODE

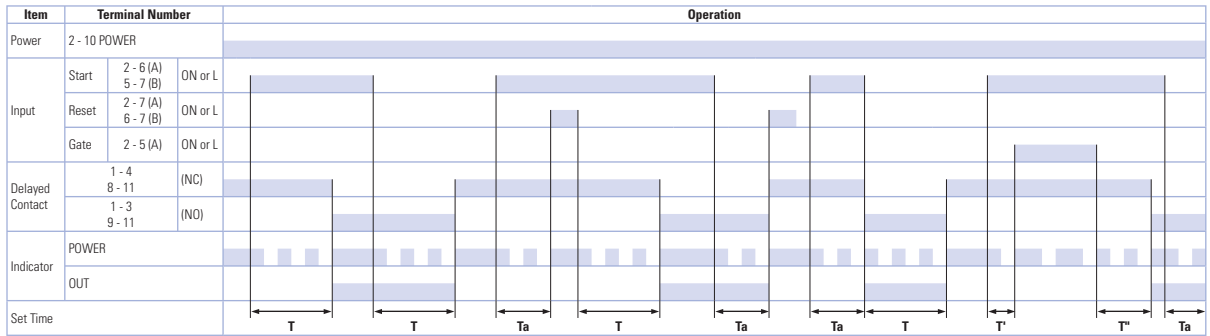

Signal OFF-Delay 2

MODE

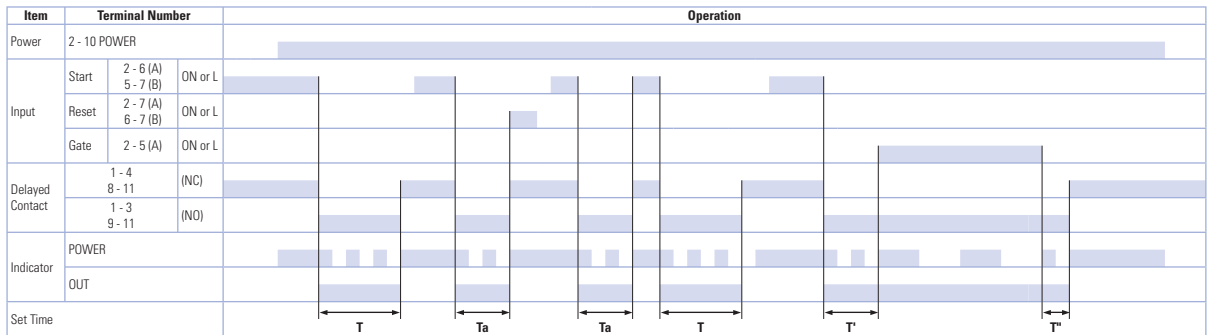

T = Set time Ta = Shorter than set time
T = T' + T''

GT3A-6 Timing Diagrams
Delayed DPDT

Operation
Mode Selection

(A Type)
(Contact Input)

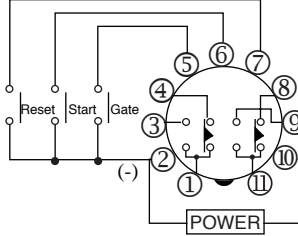

(Transistor Input)

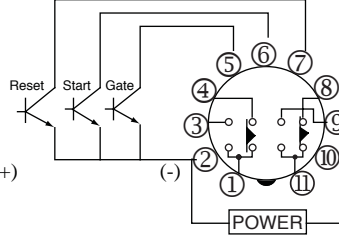

(B Type)

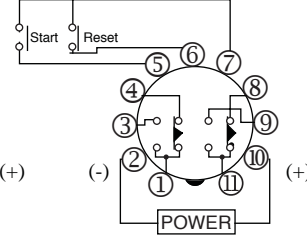

One-Shot 1

MODE

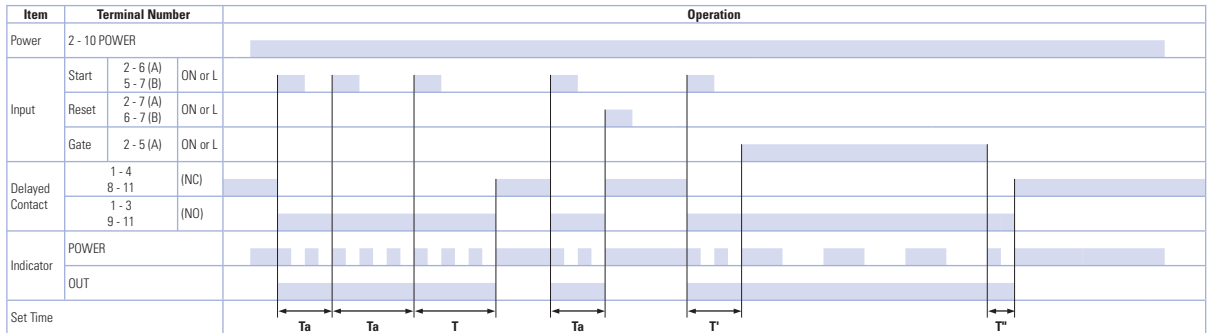

One-Shot ON-Delay

MODE

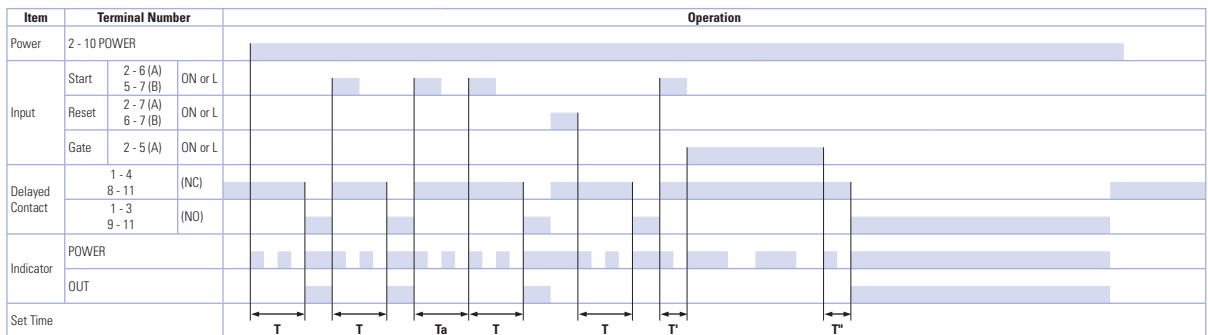

One-Shot 2

MODE

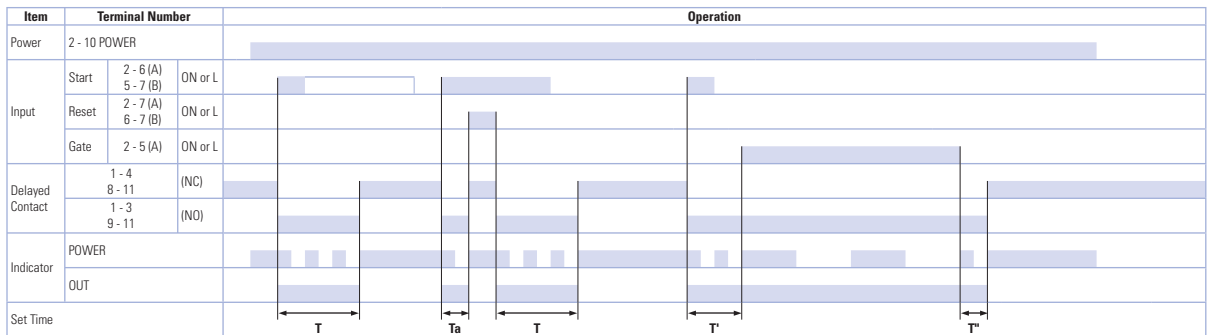

Signal ON/OFF-Delay 3

MODE

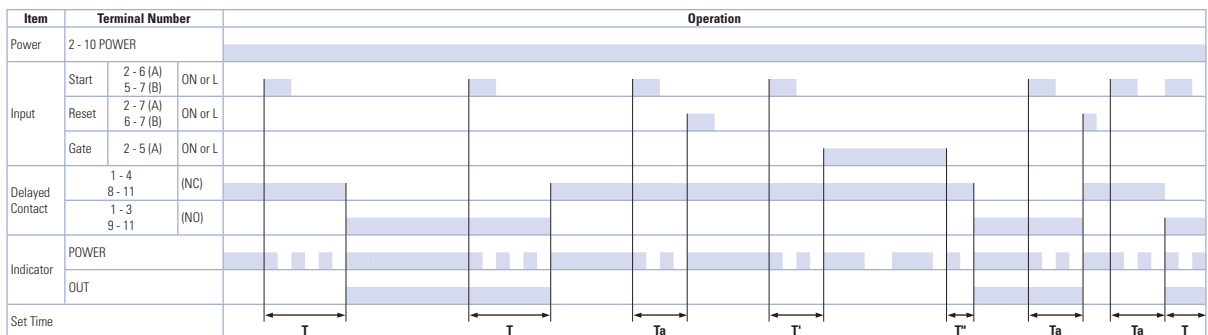

T = Set time T_a = Shorter than set time
 $T = T' + T''$

Instructions: Setting GT3A Series Timers



Step 1.	Desired Mode of Operation		Selection		Remarks		
	For Timers	Mode of Operation	① Operation Mode Selector				
Select the desired mode of operation.	GT3A-1 GT3A-2 GT3A-3	ON-delay 1	A		The desired operation mode can be selected from the A, B, C, and D modes using the Operation Mode Selector. Change the operation mode from A to B, C, and D in turn by turning the operation mode selector clockwise using a flat screwdriver which is a maximum of 0.156" (4mm) wide. The selected mode is displayed in the window.		
		Interval 1	B				
		Cycle 1	C				
		Cycle 3	D				
	GT3A-4	ON-delay 2	A				
		Cycle 2	B				
		Signal ON/OFF-delay 1	C				
		Signal OFF-delay 1	D				
	GT3A-5	Interval 2	A				
		One-shot cycle	B				
		Signal ON/OFF-delay 2	C				
		Signal OFF-delay 2	D				
	GT3A-6	One-shot 1	A				
		One-shot ON-delay	B				
		One-shot 2	C				
		Signal ON/OFF-delay 3	D				
	Step 2.	Desired Time Range		Selection		Remarks	
		Time Ranges		② Dial Selector		③ Time Range Selector	
Select the time range that contains the desired time period.	0.05 seconds to 1 second		0-1	1S	The desired time range is selected by setting both ② Dial Selector and ③ Time Range Selector.		
	0.1 seconds to 3 seconds		0-3				
	0.1 seconds to 6 seconds		0-6				
	0.15 seconds to 18 seconds		0-18				
	0.1 seconds to 10 seconds		0-1	10S			
	0.3 seconds to 30 seconds		0-3				
	0.6 seconds to 60 seconds		0-6				
	1.8 seconds to 180 seconds		0-18				
	6 seconds to 10 minutes		0-1	10M			
	18 seconds to 30 minutes		0-3				
	36 seconds to 60 minutes		0-6				
	108 seconds to 180 minutes		0-18				
	6 minutes to 10 hours		0-1	10H			
	18 minutes to 30 hours		0-3				
	36 minutes to 60 hours		0-6				
	108 minutes to 180 hours		0-18				
Step 3.	Selection						
Set the precise period of time desired by using the ④ Setting Knob.							

Switches & Pilot Lights

Display Lights

Relays & Sockets

Timers

Terminal Blocks

Circuit Breakers

GT3D – Digital Timers

Key features of the GT3D series include:

- Precise time setting using digital thumbwheel switches
- Elapsed or time remaining LCD display
- 6 time ranges, 16 timing functions
- Time delays up to 99.9 hours



UL Recognized
File No. E55996

Cert. No. BL9801133323911 (LVD)
Cert. No. E9971113332388 (EMC)



CSA Certified
File No. LR58183
File No. LR96764
File No. LR83814



Specifications

		GT3D-2	GT3D-3	GT3D-4	GT3D-8
Operation System		Solid state CMOS circuitry			
Operation		Multi-mode			Multi-mode one-shot output
Time Range		0.01s to 99.9 hours			
Rated Voltage		100 to 240V AC (50/60Hz), 24V AC (50/60Hz)/24V DC			
Contact Ratings		125V AC/250V AC, 3A; 30V DC/1A (resistive load)	125V AC/250V AC, 5A; 30V DC/5A (resistive load)		
Contact Form		Delayed SPDT + instantaneous SPDT	Delayed DPDT	Delayed DPDT	Delayed DPDT
Minimum Applicable Load		5V, 10mA (reference value)			
Voltage Tolerance		AF20 (100–240V AC): 85 to 264V AC AD24 (AC): 20.4 to 26.4V AC AD24 (DC): 21.6 to 26.4V DC			
Error		±0.3% ±50ms (voltage, repeat, and temperature)			
Setting Error		±0.5% ±50ms			
Reset Time		60ms maximum			
Insulation Resistance		100MΩ minimum			
Dielectric Strength		Between power and output terminals: 2,000V AC, 1 minute Between contacts of different poles: 2,000V AC, 1 minute Between contacts of the same pole: 750V AC, 1 minute			
Power Consumption (approximate)	AF20	11.8VA	11.6VA	3.7VA (100V AC, 60Hz) 11.6VA (200V AC, 60Hz)	
	AD24 AC/DC	1VA/0.8W	2.1VA/0.9W	2.1VA /0.9W	
Mechanical Life		10,000,000 operations minimum	5,000,000 operations minimum		
Electrical Life (at rated load)		50,000 operations minimum	100,000 operations minimum		
Outputs	Relay	250V AC, 3A, 30V DC, 1A (resistive load)	240V AC/, 24V DC, 5A (resistive load)		
Vibration Resistance		100N (approximate 10G)			
Shock Resistance		Operating extremes: 100N (approximate 10G) Damage limits: 500N (approximate 50G)			
Operating Temperature		–10 to +50°C			
Storage Temperature		–30 to +80°C			
Operating Humidity		45 to 85% RH			
Weight (approximate)		70g	75g	76g	
Housing Color		Gray			

Part Number List
Part Numbers: GT3D-1/GT3D-2/GT3D-3

Mode of Operation	Time Range	Output	Contact	Rated Voltage Code	Complete Part No.		
					8-Pin	11-Pin	
1-A: ON-delay 1 1-B: Interval 1 first 1-C: Cycle 1 (OFF first) 1-D: Cycle 3 (ON first)	0.01s to 99.9 hours	250V AC, 3A, 30V DC, 1A (resistive load)	Delayed SPDT + instantaneous SPDT	100 to 240V AC (50/60Hz)	GT3D-2AF20	GT3D-2EAF20	
				24V AC/DC	GT3D-2AD24	—	
		240V AC, 24V DC, 5A (resistive load)		Delayed DPDT	100 to 240V AC (50/60Hz)	GT3D-3AF20	GT3D-3EAF20
					24V AC/DC	GT3D-3AD24	—

Part Numbers: GT3D-4

Mode of Operation	Time Range	Output	Contact	Rated Voltage Code	Complete Part No.	
					A (11-Pin)	B (11-Pin)
1-A: ON-delay 1 1-B: Interval 1 first 1-C: Cycle 1 (OFF first) 1-D: Cycle 3 (ON first) 2-A: ON-delay 2 2-B: Cycle 2 2-C: Signal ON/OFF-delay 1 2-D: Signal OFF-delay 1 2-E: Interval 2 2-F: One-shot cycle 3-A: Signal ON/OFF-delay 2 3-B: Signal OFF-delay 2 3-C: One-shot 1 3-D: One-shot ON-delay 3-E: One-shot 2 3-F: Signal ON/OFF-delay 3	0.01s to 99.9 hours	240V AC/24V DC, 5A (resistive load)	Delayed DPDT	100 to 240V AC (50/60Hz)	GT3D-4AF20	GT3D-4EAF20
				24V AC/DC	GT3D-4AD24	—

Part Numbers: GT3D-8

Mode of Operation	Time Range	Output	Contact	Rated Voltage Code	Complete Part No. (11-Pin)
1: ON-delay one-shot 1 2: Cycle one-shot 3: ON-delay one-shot 2	0.01s to 99.9 hours	240V AC/24V DC, 5A (resistive load)	Delayed DPDT	100 to 240V AC (50/60Hz)	GT3D-8AF20
				24V AC/DC	GT3D-8AD24

-
1. For wiring schematics and timing diagrams GT3D, see pages 815 to 822.
 2. For more details about time ranges, see instructions on page 823.
 3. A (11-pin) and B (11-pin) differ in the way inputs are wired.
 4. For socket and accessory part numbers, see page 838.
 5. For timing diagrams overview, see page 794.

Timing Diagrams/Schematics

GT3D-2 Timing Diagrams
Delayed SPDT + Instantaneous SPDT

Operation
Mode Selection

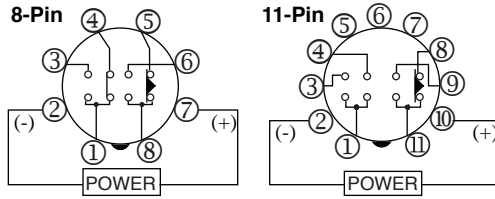

ON-Delay 1

Time Remaining

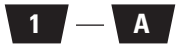

Time Elapsed

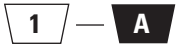

Item	Terminal Number	Operation
Set Time		Set Time
Power	2 - 7 (8p) 2 - 10 (11p)	
Delayed Contact	1 - 4, 5 - 8 (8p) (NC)	
	1 - 4, 8 - 11 (11p) (NO)	
	1 - 3, 6 - 8 (8p) (NO) 1 - 3, 9 - 11 (11p) (NO)	
Instantaneous Contact	1 - 4 (NC)	
	1 - 3 (NO)	
Indicator	OUT	
Digital Time Display	DOWN	
	UP	

Interval 1

Time Remaining



Time Elapsed

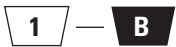

Item	Terminal Number	Operation
Set Time		Set Time
Power	2 - 7 (8p) 2 - 10 (11p)	
Delayed Contact	1 - 4, 5 - 8 (8p) (NC)	
	1 - 4, 8 - 11 (11p) (NO)	
	1 - 3, 6 - 8 (8p) (NO) 1 - 3, 9 - 11 (11p) (NO)	
Instantaneous Contact	1 - 4 (NC)	
	1 - 3 (NO)	
Indicator	OUT	
Digital Time Display	DOWN	
	UP	

Cycle 1

(OFF first)

Time Remaining

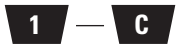

Time Elapsed

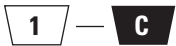

Item	Terminal Number	Operation
Set Time		Set Time
Power	2 - 7 (8p) 2 - 10 (11p)	
Delayed Contact	1 - 4, 5 - 8 (8p) (NC)	
	1 - 4, 8 - 11 (11p) (NO)	
	1 - 3, 6 - 8 (8p) (NO) 1 - 3, 9 - 11 (11p) (NO)	
Instantaneous Contact	1 - 4 (NC)	
	1 - 3 (NO)	
Indicator	OUT	
Digital Time Display	DOWN	
	UP	

Cycle 3

(ON first)

Time Remaining



Time Elapsed

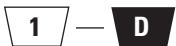

Item	Terminal Number	Operation
Set Time		Set Time
Power	2 - 7 (8p) 2 - 10 (11p)	
Delayed Contact	1 - 4, 5 - 8 (8p) (NC)	
	1 - 4, 8 - 11 (11p) (NO)	
	1 - 3, 6 - 8 (8p) (NO) 1 - 3, 9 - 11 (11p) (NO)	
Instantaneous Contact	1 - 4 (NC)	
	1 - 3 (NO)	
Indicator	OUT	
Digital Time Display	DOWN	
	UP	

GT3D-3 Timing Diagrams
Delayed DPDT

Operation Mode Selection

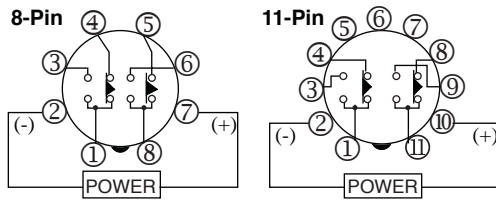

ON-Delay 1

Time Remaining

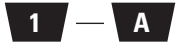

Time Elapsed

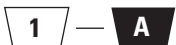

Item	Terminal Number	Operation
Set Time		Set Time
Power	2 - 7 (8p) 2 - 10 (11p)	
Delayed Contact	1 - 4, 5 - 8 (8p) 1 - 4, 8 - 11 (11p)	(NC)
Indicator	OUT	
Digital Time Display	DOWN UP	

Interval 1

Time Remaining



Time Elapsed

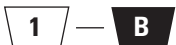

Item	Terminal Number	Operation
Set Time		Set Time
Power	2 - 7 (8p) 2 - 10 (11p)	
Delayed Contact	1 - 4, 5 - 8 (8p) 1 - 4, 8 - 11 (11p)	(NC)
Indicator	OUT	
Digital Time Display	DOWN UP	

Cycle 1

(OFF first)

Time Remaining



Time Elapsed

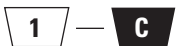

Item	Terminal Number	Operation
Set Time		Set Time
Power	2 - 7 (8p) 2 - 10 (11p)	
Delayed Contact	1 - 4, 5 - 8 (8p) 1 - 4, 8 - 11 (11p)	(NC)
Indicator	OUT	
Digital Time Display	DOWN UP	

Cycle 3

(ON first)

Time Remaining



Time Elapsed

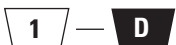

Item	Terminal Number	Operation
Set Time		Set Time
Power	2 - 7 (8p) 2 - 10 (11p)	
Delayed Contact	1 - 4, 5 - 8 (8p) 1 - 4, 8 - 11 (11p)	(NC)
Indicator	OUT	
Digital Time Display	DOWN UP	

Switches & Pilot Lights

Display Lights

Relays & Sockets

Timers

Terminal Blocks

Circuit Breakers

GT3D-4 Timing Diagrams

These timers require a start input. A gate and reset input are optional. Inputs are controlled by external pushbuttons. Reset occurs when the power is removed or when the reset input is supplied. The gate signal can be used to interrupt (freeze) timer functions. Timer functions resume when the gate input is removed. B style timers are not equipped for gate input.

Delayed DPDT

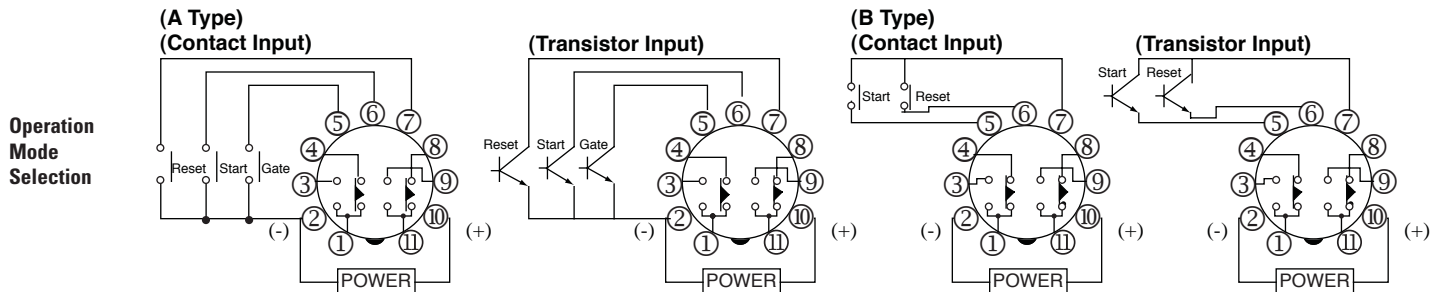

ON-Delay 1

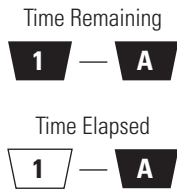

Item	Terminal Number	Operation
Power	2 - 10	[Timing diagram showing power pulse]
Delayed Contact	(NC) 1 - 4 8 - 11	[Timing diagram showing normally closed contact]
	(NO) 1 - 3 9 - 11	[Timing diagram showing normally open contact]
Indicator	OUT	[Timing diagram showing indicator output]
Digital Time Display	DOWN	[Timing diagram showing digital display decreasing]
	UP	[Timing diagram showing digital display increasing]
Set Time		[Timing diagram showing set time interval]

Interval 1

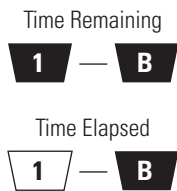

Item	Terminal Number	Operation
Power	2 - 10	[Timing diagram showing power pulse]
Delayed Contact	(NC) 1 - 4 8 - 11	[Timing diagram showing normally closed contact]
	(NO) 1 - 3 9 - 11	[Timing diagram showing normally open contact]
Indicator	OUT	[Timing diagram showing indicator output]
Digital Time Display	DOWN	[Timing diagram showing digital display decreasing]
	UP	[Timing diagram showing digital display increasing]
Set Time		[Timing diagram showing set time interval]

Switches & Pilot Lights

Display Lights

Relays & Sockets

Timers

Terminal Blocks

Circuit Breakers

GT3D-4 Timing Diagrams

Switches & Pilot Lights

Cycle 1
(OFF first)

Time Remaining



Time Elapsed

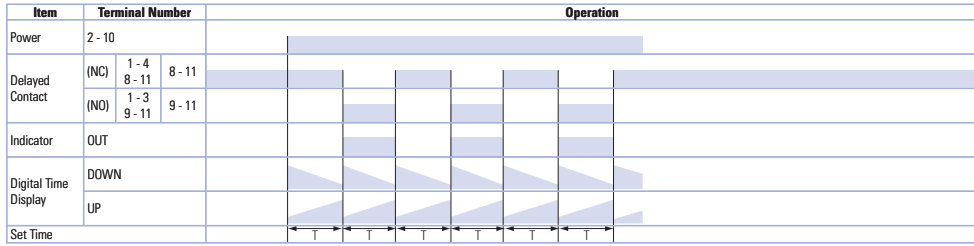
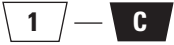

Display Lights

Cycle 3
(ON first)

Time Remaining

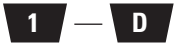

Time Elapsed

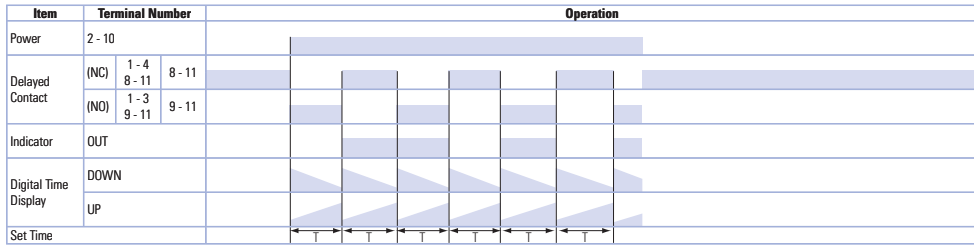
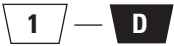

Relays & Sockets

ON-Delay 2

Time Remaining

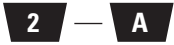

Time Elapsed

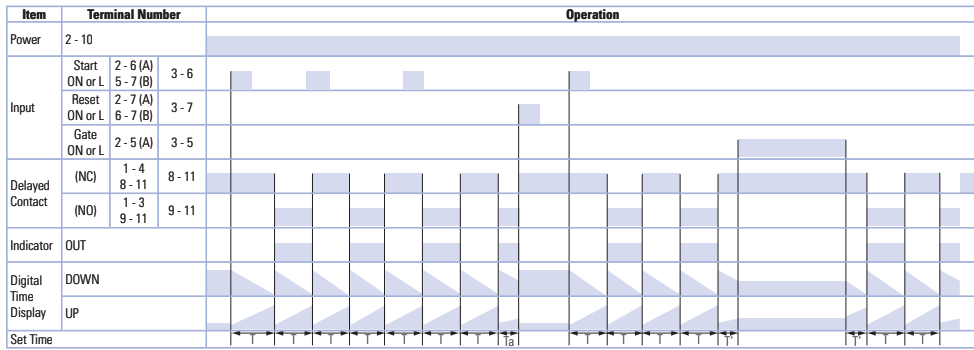
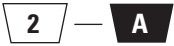

Timers

Terminal Blocks

Circuit Breakers

GT3D-4 Timing Diagrams

Cycle 2

Time Remaining



Time Elapsed

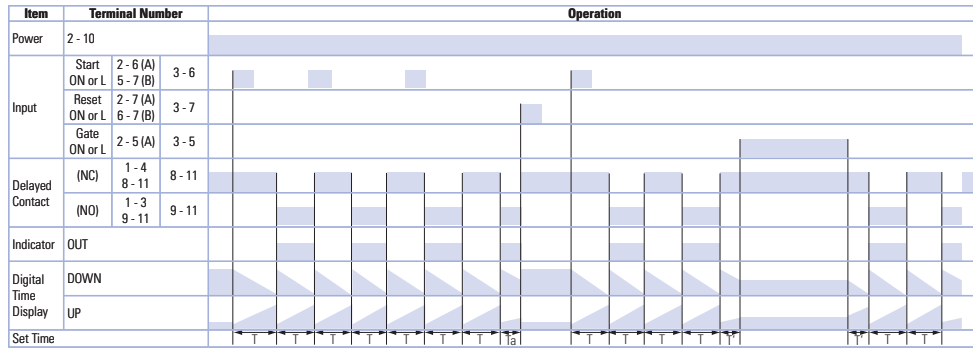
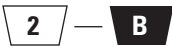

Signal ON/OFF-Delay 1

Time Remaining



Time Elapsed

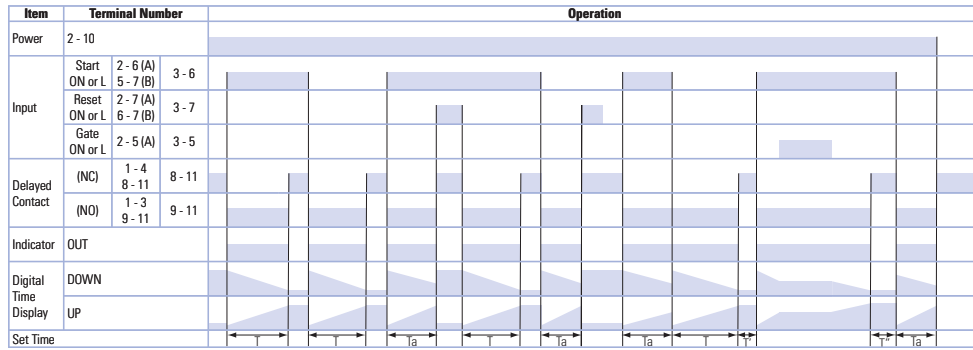
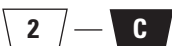

Singal OFF-Delay 1

Time Remaining



Time Elapsed

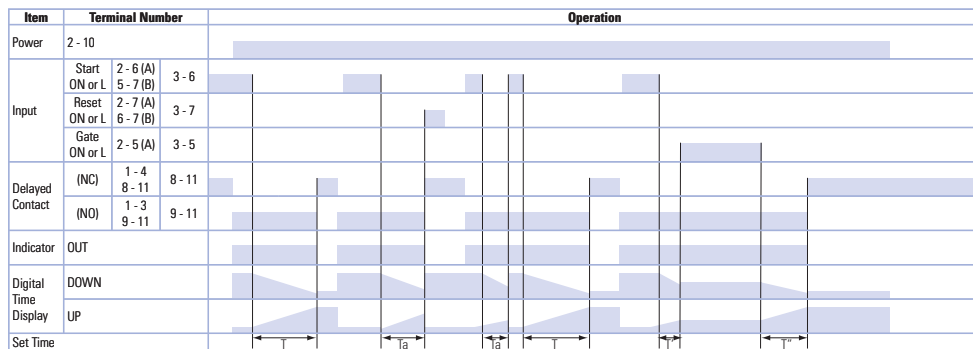
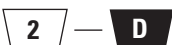

Interval 2

Time Remaining



Time Elapsed

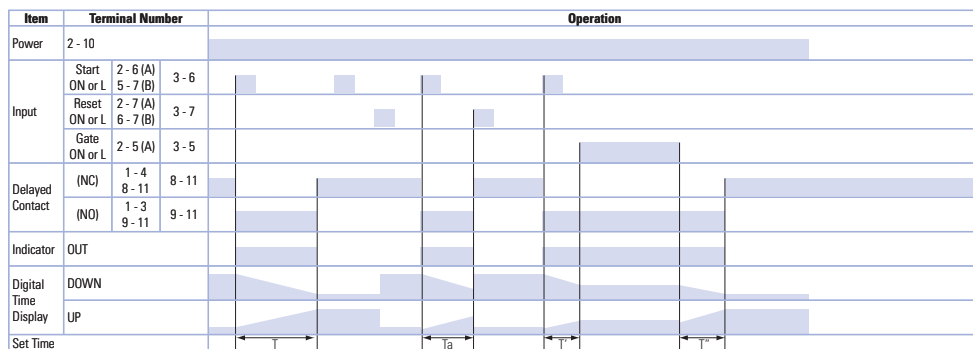
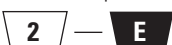

GT3D-4 Timing Diagrams

Switches & Pilot Lights

One-Shot Cycle

Time Remaining



Time Elapsed

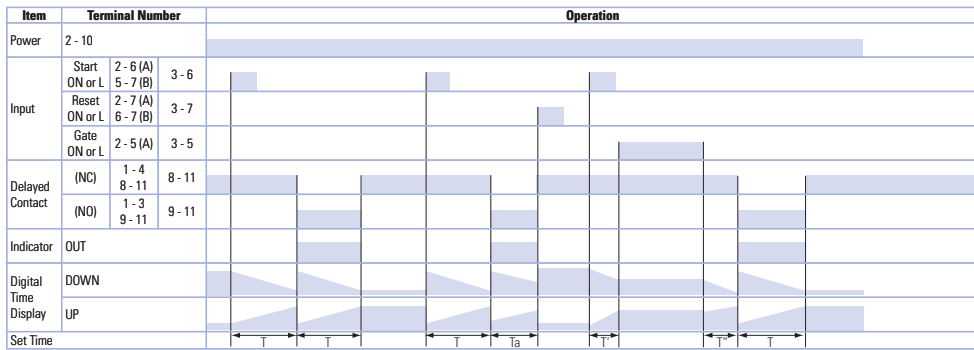
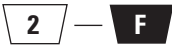

Display Lights

Signal ON/OFF-Delay 2

Time Remaining



Time Elapsed

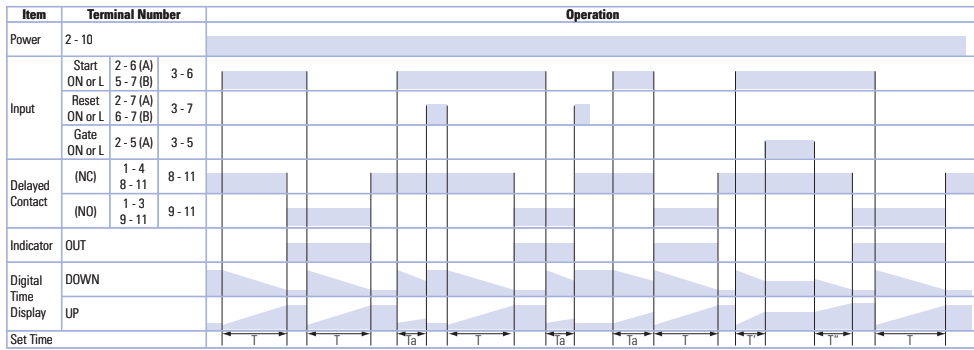
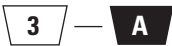

Relays & Sockets

Singal OFF-Delay 2

Time Remaining



Time Elapsed

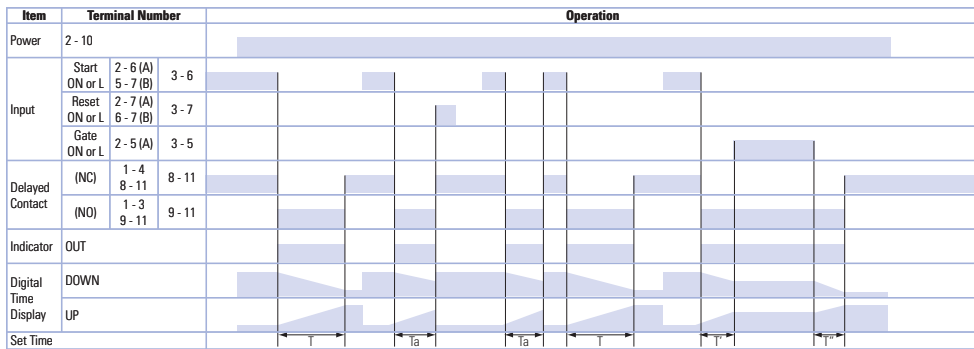
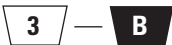

Timers

One-Shot 1

Time Remaining



Time Elapsed

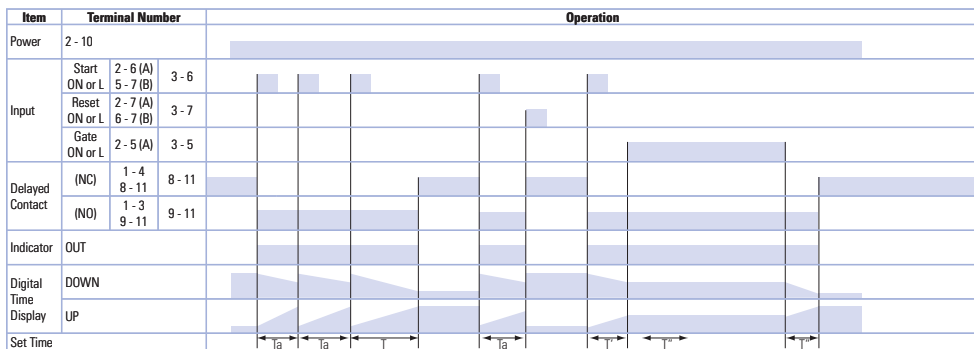
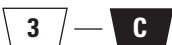

Terminal Blocks

Circuit Breakers

GT3D-4 Timing Diagrams

One-Shot ON-Delay

Time Remaining



Time Elapsed

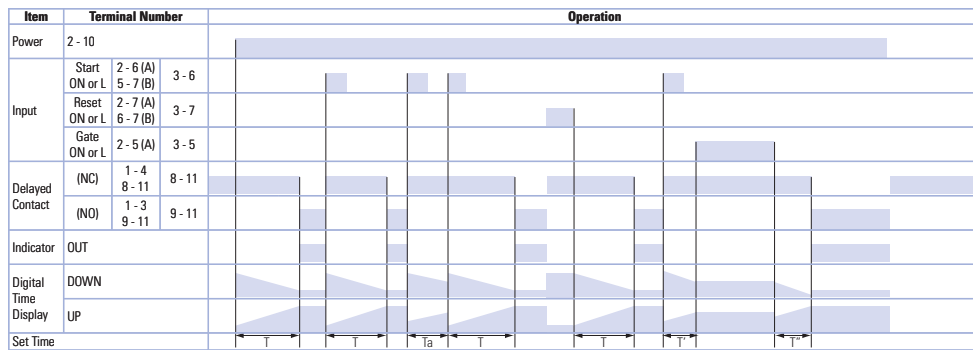
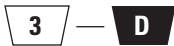

One-Shot 2

Time Remaining



Time Elapsed

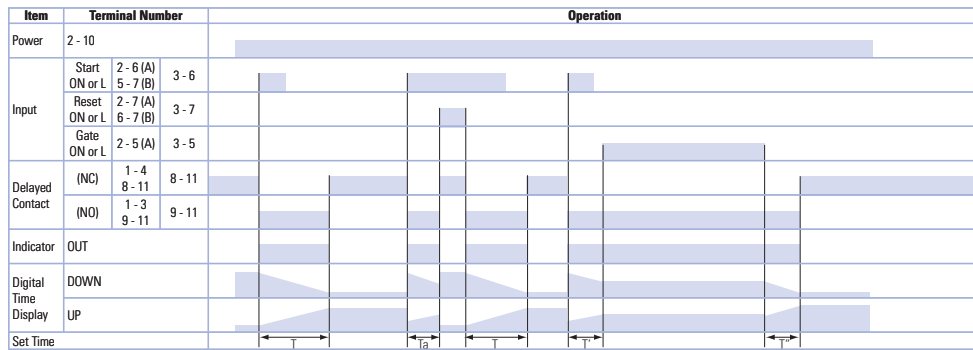
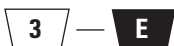

Signal ON/OFF-Delay 3

Time Remaining



Time Elapsed

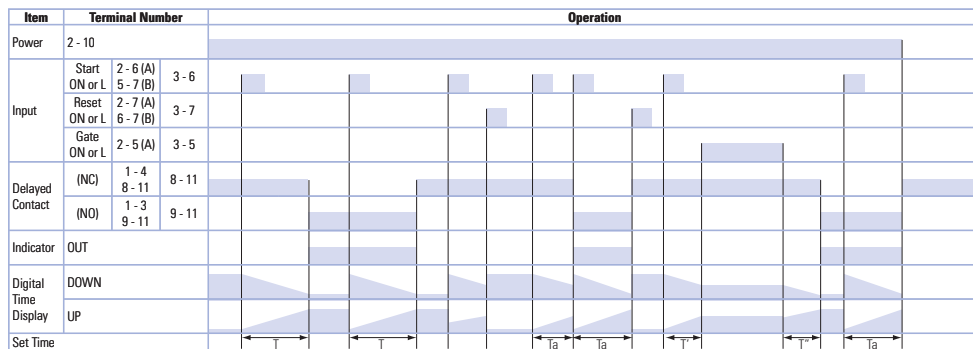
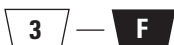

Switches & Prior Lights

Display Lights

Relays & Sockets

Timers

Terminal Blocks

Circuit Breakers

GT3D-8 Timing Diagrams
Delayed DPDT

Operation
Mode Selection

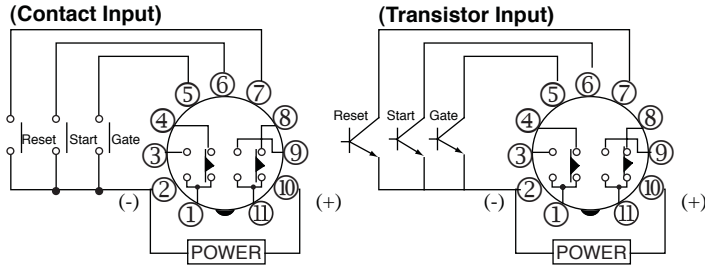

ON-Delay One-Shot 1

Time Remaining **1**
Time Elapsed **1**

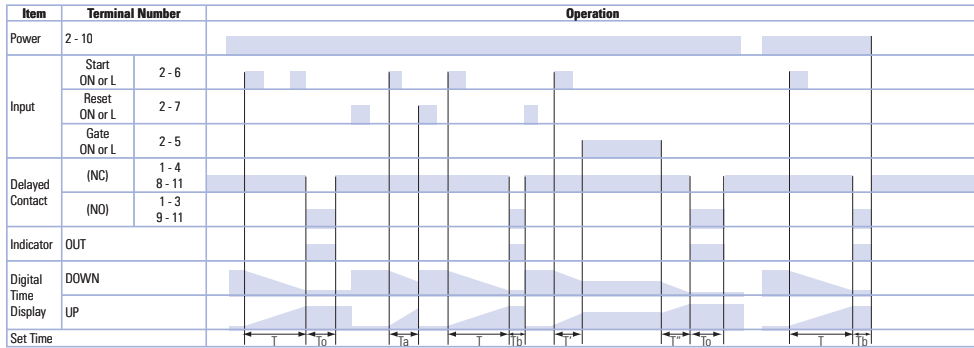

Cycle One-Shot

Time Remaining **2**
Time Elapsed **2**

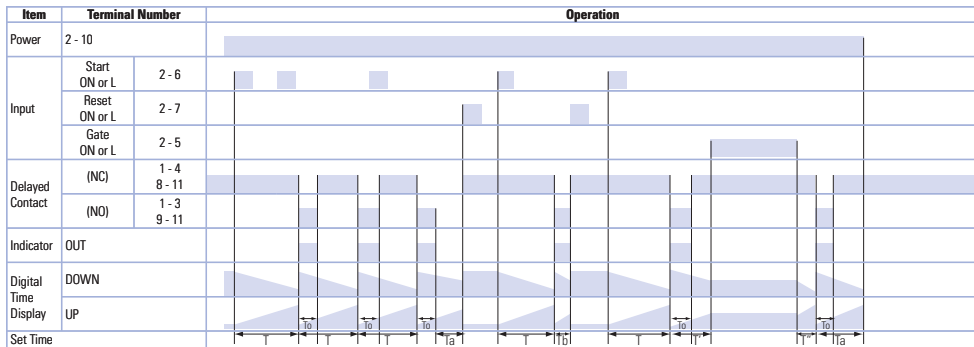

ON-Delay One-Shot 2

Time Remaining **3**
Time Elapsed **3**

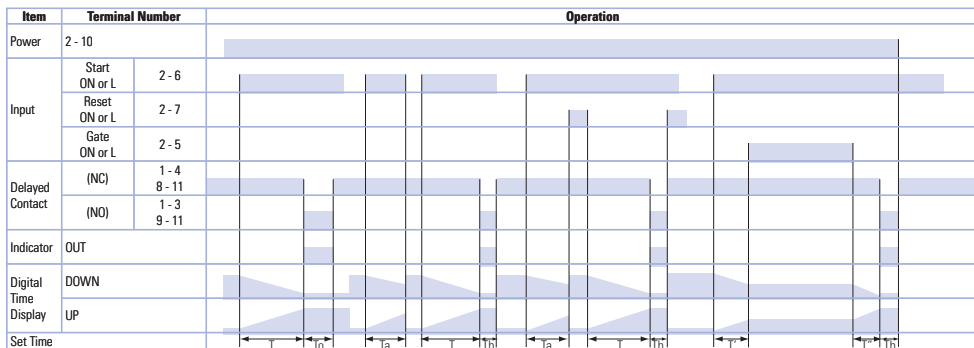

T = Set time
 Ta = Shorter than set time
 Tb = Shorter than single-shot output time
 T = T' + T"
 T0 = Single-shot output time (selected from A, B, C, D, E or F)

Instructions: Setting GT3D-2, GT3D-3 Timers

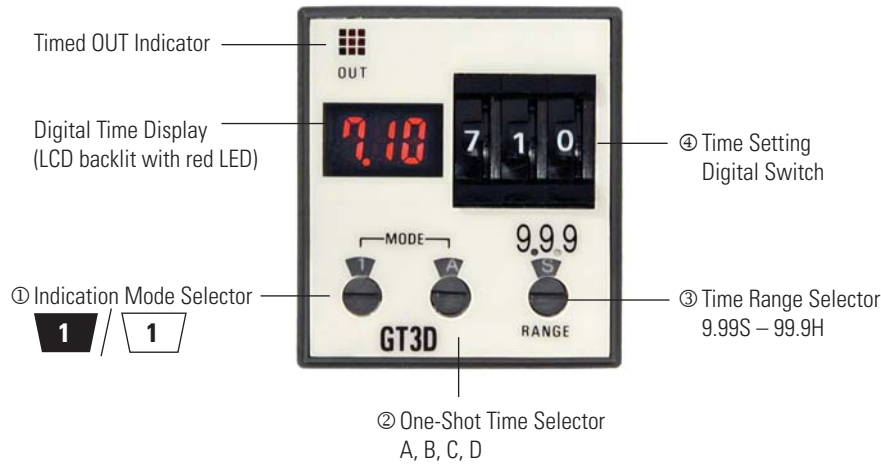

Step 1	Desired Mode/Selection				Remarks
	Time Display Mode	① Indicator Mode Selector	Operation Mode	② Operation Mode Selector	
Select the desired time display and operation modes.	Time elapsed		ON-delay 1	A	1. Use the flat screwdriver to set the selectors. Since selectors do not turn all the way around, both clockwise and counterclockwise rotation may be necessary. 2. The ① Indicator Mode Selector determines whether the Digital Time Display shows the time elapsed or time remaining. The ② Operation Mode Selector determines the desired operation mode. Decide which display and mode is desired, then use these two selectors ①② to set the operation mode. 3. The ② Operation Mode Selector has two blank modes which are not intended for use. Always have this selector set to A, B, C, or D.
	Time remaining				
	Time elapsed		Interval	B	
	Time remaining				
	Time elapsed		Cycle 1	C	
	Time remaining				
	Time elapsed		Cycle 3	D	
	Time remaining				
	Step 2	Desired Operation	Selection		
Select a time range that contains the desired period of time.	Base Time Ranges	③ Time Range Selector		1. The ③ Time Range Selector controls both the decimal point indicator (9.99, 99.9, 999) and the time increment indicators S (seconds), M (minutes), and H (hours). 2. Chose which base time range contains the targeted timer setting. Then use the ③ Time Range Selector to set the decimal point indicator and time increment indicator to its corresponding pair of settings. 3. Since these configurations offer a complete range of settings from 0.01 seconds to 99.9 hours, the setting of 9.99 for minutes and the 9.99 and 999 settings for hours are not listed and should not be used.	
		Decimal Point Indicator	Time Increment Indicator		
	0.01 seconds to 9.99 seconds	9.99			
	0.1 seconds to 99.9 seconds	99.9			
	1 second to 999 seconds	999			
	0.1 minutes to 99.9 minutes	99.9			
	1 minute to 999 minutes	999			
0.1 hours to 99.9 hours	99.9				
Step 3	Desired Operation	Selection		Remarks	
Set the precise period of time desired by using the ④ Time Setting Digital Switch.				Use the ④ Time Setting Digital Switch to set the desired period of time. It is important to remember that the setting of the ③ Time Range Selector determines the units of time measurement as well as the implied decimal point location.	

It is important to remember that the ③ Time Range Selector not only selects the time range but also influences the interpretation of the Digital Time Display. Changing the ③ Time Range Selector setting changes the units of time measurement (seconds, minutes, hours) as well as the decimal point location.

Instructions: Setting GT3D-4 Timers

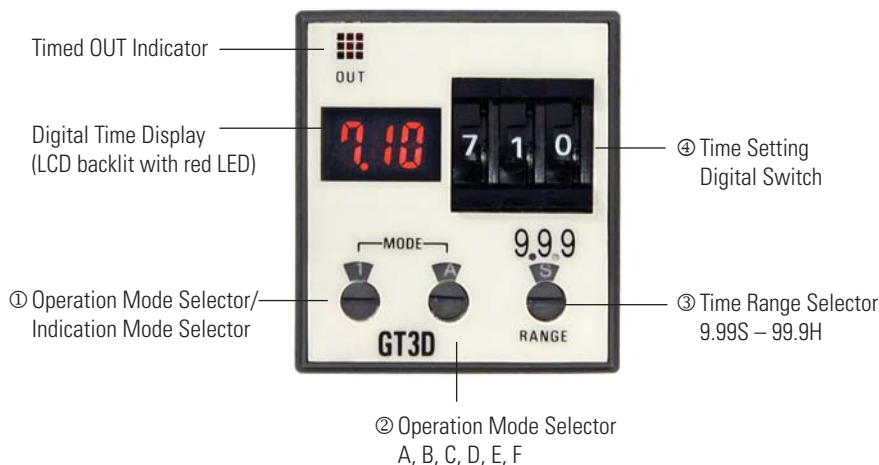

Step 1	Desired Mode/Selection				Remarks
	Time Display Mode	① Indicator Mode Selector	Operation Mode	② Operation Mode Selector	
Select the desired time display and operation modes.	Time elapsed		ON-delay 1 Interval 1 Cycle 1 D: Cycle 3	A B C D	1. Use a flat screwdriver to set the selectors. Since selectors do not turn all the way around, both clockwise and counterclockwise rotation is necessary. 2. The ① Indicator Mode Selector determines whether the Digital Time Display shows the time elapsed or time remaining. The ② Operation Mode Selector determines the desired operation mode. Decide which display and mode is desired; then use these two selectors ① ② to set the operation mode. 3. When using the indicator mode setting "1," the ② Operation Mode Selector has two blank modes which are not intended for use. When using mode setting "1," always have the operation mode selector set to A, B, C, or D.
	Time remaining				
	Time elapsed		ON-delay 2 Cycle 2 Signal ON/OFF-delay 2 Signal OFF-delay 1 Interval 2 One-shot cycle	A B C D E F	
	Time remaining				
	Time elapsed		Signal ON/OFF-delay 2 Signal OFF-delay 2 One-shot 1 One-shot ON-delay One-shot 2 Signal ON/OFF-delay 3	A B C D E F	
	Time remaining				
Step 2	Desired Operation	Selection		Remarks	
Select a time range that contains the desired period of time.	Base Time Ranges	③ Time Range Selector		1. The ③ Time Range Selector controls both the decimal point indicator (9.99, 99.9, 999) and the time increment indicators S (seconds), M (minutes), and H (hours). 2. Chose which base time range contains the targeted timer setting. Then use the ③ Time Range Selector to set the decimal point indicator and time increment indicator to its corresponding pair of settings. 3. Since these configurations offer a complete range of settings from 0.01 seconds to 99.9 hours, the setting of 9.99 for minutes and the 9.99 and 999 settings for hours are not listed and should not be used.	
		Decimal Point Indicator	Time Increment Indicator		
	0.01 seconds to 9.99 seconds	9.99			
	0.1 seconds to 99.9 seconds	99.9			
	1 second to 999 seconds	999			
	0.1 minutes to 99.9 minutes	99.9			
1 minute to 999 minutes	999				
0.1 hours to 99.9 hours	99.9				
Step 3	Desired Operation	Selection		Remarks	
Set the precise period of time desired by using the ④ Time Setting Digital Switch.				Use the ④ Time Setting Digital Switch to set the desired period of time. It is important to remember that the setting of the ③ Time Range Selector determines the units of time measurement as well as the implied decimal point location.	

It is important to remember that the ③ Time Range Selector not only selects the time range but also influences the interpretation of the Digital Time Display. Changing the ③ Time Range Selector setting changes the units of time measurement (seconds, minutes, hours) as well as the decimal point location.

Switches & Pilot Lights

Display Lights

Relays & Sockets

Timers

Terminal Blocks

Circuit Breakers

Instructions: Setting GT3D-8 Timers

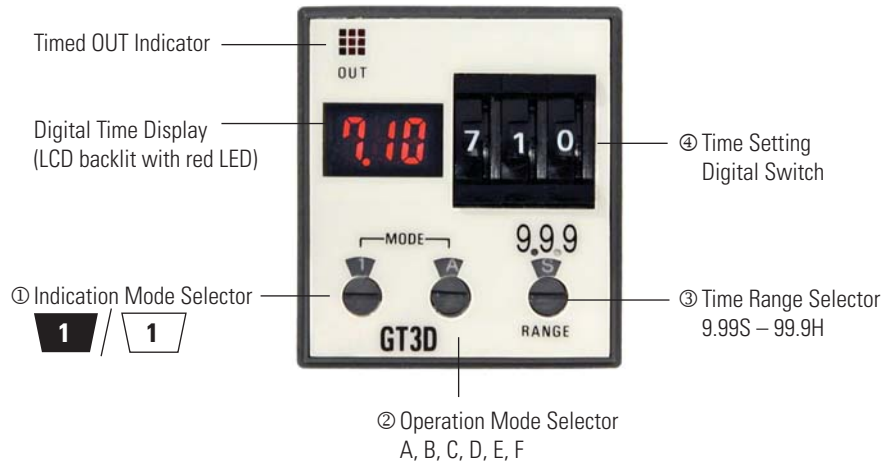

Step 1	Desired Mode of Operation		Selection		Remarks
Select the time display and operation modes.	Operation Mode	Time elapsed	① Indicator Mode Selector		1. Use a flat screwdriver to set the selectors. Since selectors do not turn all the way around, both clockwise and counterclockwise rotation is necessary. 2. The GT3D-8 ① Indicator Mode Selector selects both whether the Digital Time Display displays the time elapsed or time remaining and also the mode of operation. Decide which display and mode is desired. Then use this selector to set the operation mode.
		Time remaining	①		
	Cycle One-Shot	Time elapsed	②		
		Time remaining	②		
	ON-Delay One-Shot 2	Time elapsed	③		
		Time remaining	③		
Step 2	Desired Mode of Operation		Selection		Remarks
Select the single shot output time.	Desired Single-Shot Output Time		② Single-Shot Output Time Selector		On the GT3D-8 timers, the desired single-shot output time can be selected from the A, B, C, D, E, and F modes using the ② One-Shot Output Time Selector.
	0.1 seconds		A		
	0.5 seconds		B		
	1 second		C		
	5 seconds		D		
	10 seconds		E		
50 seconds		F			
Step 3	Desired Operation		Selection		Remarks
Select a time range that contains the desired period of time.	Base Time Ranges		③ Time Range Selector		1. The ③ Time Range Selector controls both the decimal point indicator (9.99, 99.9, 999) and the time increment indicators S (seconds), M (minutes), and H (hours). 2. Chose which base time range contains the targeted timer setting. Then use the ③ Time Range Selector to set the decimal point indicator and time increment indicator to its corresponding pair of settings. 3. Since these configurations offer a complete range of settings from 0.01 seconds to 99.9 hours, the setting of 9.99 for minutes and the 9.99 and 999 settings for hours are not listed and should not be used.
	0.01 seconds to 9.99 seconds		Decimal Point Indicator	Time Increment Indicator	
	0.1 seconds to 99.9 seconds		9.99	S	
	1 second to 999 seconds		99.9	M	
	0.1 minutes to 99.9 minutes		999	H	
	1 minute to 999 minutes		99.9		
	0.1 hours to 99.9 hours		999		
Step 4	Desired Operation		Selection		Remarks
Set the precise period of time desired by using the ④ Time Setting Digital Switch.					
Use the ④ Time Setting Digital Switch to set the desired period of time. It is important to remember that the setting of the ③ Time Range Selector determines the units of time measurement as well as the implied decimal point location.					



It is important to remember that the ③ Time Range Selector not only selects the time range but also influences the interpretation of the Digital Time Display. Changing the ③ Time Range Selector setting changes the units of time measurement (seconds, minutes, hours) as well as the decimal point location.

Switches & Pilot Lights

Display Lights

Relays & Sockets

Timers

Terminal Blocks

Circuit Breakers

GT3F Series – True OFF Delay Timers



Key features of the GT3F series include:

- “True” power OFF-delay up to 10 minutes
- No external control switch necessary
- Available with reset inputs
- Mountable in sockets or flush panel



Specifications

	GT3F-1	GT3F-2
Operation	True power OFF-delay	
Time Range	0.1 seconds to 600 seconds	
Rated Voltage	100 to 240V AC, 50/60Hz 24V AC/DC	
Contact Rating	250V AC/30V DC, 5A (resistive load)	250V AC/30V DC, 3A (resistive load)
Contact Form	SPDT	DPDT
Minimum Power Application Time	1 second	
Voltage Tolerance	AF20: 100 to 240V AC AD24: 21.6 to 26.4VDC, 20.4 to 26.4VAC	
Repeat Error	±0.2%, ±10 msec	
Voltage Error	±0.2%, ±10 msec	
Temperature Error	±0.2%, ±10 msec	
Setting Error	±10% maximum	
Insulation Resistance	100MW minimum	
Dielectric Strength	Between power and output terminals: 2,000V AC, 1 minute (SPDT) 1,500V AC, 1 minute (DPDT) Between contacts on different poles: 1,000V AC, 1 minute (DPDT) Between contacts of the same pole: 750V AC, 1 minute	
Power Consumption	AF20: 3.7VA (200V AC, 60Hz) AD24: 0.8W (DC), 1.2VA (AC)	
Mechanical Life	20,000,000 operations minimum	
Electrical Life	100,000 operations minimum	
Vibration Resistance	100m/sec ² (approximate 10G)	
Shock Resistance	Operating extremes: 100 m/sec ² (approximate 10G) Damage limits: 500 m/sec ² (approximate 50G)	
Operating Temperature	-10 to +50°C	
Storage Temperature	-30 to +80°C	
Operating Humidity	45 to 85% RH	
Weight (approximate)	77g	79g

1. An inrush current flows during the minimum power application time. AF20: approximate 0.4A, AD24: approximate 1.2A
2. GT3F does not read the preset time range shown on the knob after power is turned off. Note that minimizing the preset time, by turning the knob to zero, does not shorten the delay time after power is removed.

Switches & Pilot Lights

Display Lights

Relays & Sockets

Timers

Terminal Blocks

Circuit Breakers

Part Numbering List

GT3F

Mode of Operation	Rated Voltage Code	Time Range	Output	Contact	Optional Input	Complete Part Number	
						8-Pin	11-Pin
Power OFF-delay	AF20: 100 to 240VAC (50/60Hz)	0.1 seconds to 600 seconds	250V AC, 5A,	Delayed SPDT	Reset	GT3F-1AF20	GT3F-1EAF20
			30V DC, 5A (resistive load)			GT3F-1AD24	GT3F-1EAD24
	AD24: 24V AC/DC		250V AC, 3A,	Delayed DPDT	None (8p) Reset (11p)	GT3F-2AF20	GT3F-2EAF20
			30V DC, 3A (resistive load)			GT3F-2AD24	GT3F-2EAD24



Optional reset input resets the contact to the OFF state before time out.

Timing Diagrams/Schematics

GT3F-1 Timing Diagrams

GT3F-1 (8-pin)	GT3F-1E (11-pin)
Delayed SPDT Output, with Reset Input	

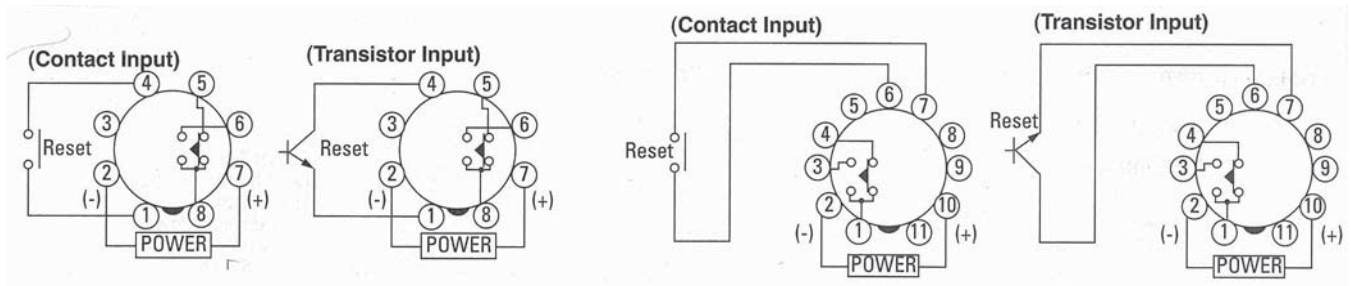

Item	Terminal Number	Operation
Power	2 - 7 (8p) 2 - 10 (11p)	
Reset Input	1 - 4 (8p) 6 - 7 (11p)	ON or L
Delayed Contact	5 - 8 (8p) 1 - 4 (11p)	(NC)
	6 - 8 (8p) 1 - 3 (11p)	(NO)
Indicator	POWER	
Set Time		Tr, T, Ta, Ts, T



T = Set time
 Ta = Shorter than set time
 Ts = 1 Second
 Tr = Minimum Power Application Time
 GT3F-1: 1 Second

1. For time ranges, see page 829.
2. For sockets and accessory part numbers, see page 838.
3. When power is applied, the NO output contact closes. When power is removed, the timing period begins. When time has elapsed, the NO contact opens.
4. For the timing diagram overview, see page 794.

GT3F-2 Timing Diagrams

GT3F-2 (8-pin)

GT3F-2E (11-pin)

Delayed DPDT Output

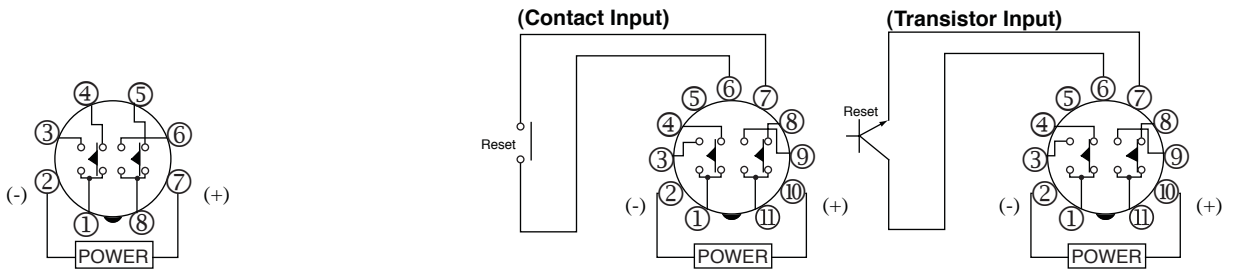

8-Pin Type

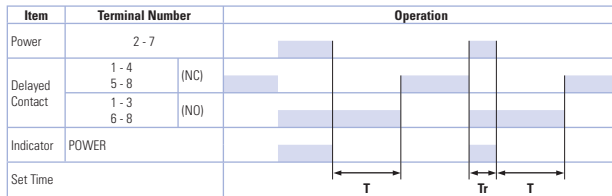

11-Pin Type

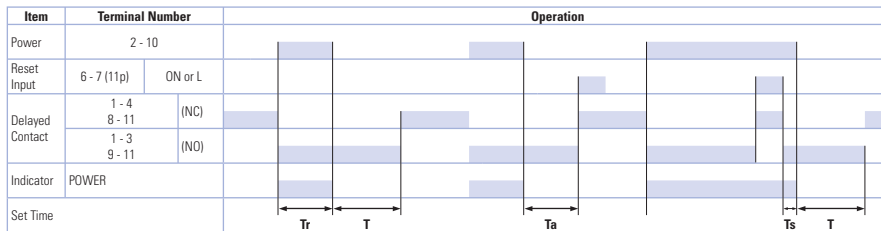

When power is applied, the NO contact closes. When power is removed, the timing period begins. When time has elapsed, the NO contact opens. Optional reset input will return contacts to original state before time elapses.

- T = Set time
- Ta = Shorter than set time
- Ts = 1 Second
- Tr = Minimum Power Application Time
- GT3F-1: 1 Second

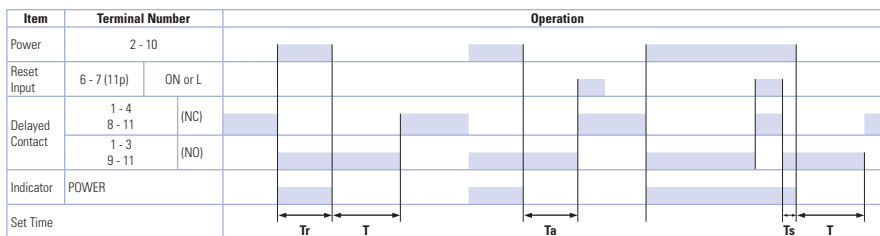

Instructions: Setting GT3F Series Timers



Step 1	Desired Operation	Selection		Remarks
	Base Time Ranges	① Dial Selector	② Time Range Selector	
Select a time range that contains the desired period of time.	0.1s to 1s	0 to 1	1s	Time range can be selected from 1S and 10S using a flat screwdriver and five different dials of 0 to 1, 0 to 3, 0 to 6, 0 to 18, and 0 to 60 are displayed in the six windows by turning the Dial Selector, allowing for selecting the best suited scale. Note that the switch does not turn infinitely.
	0.1s to 3s	0 to 3		
	0.1s to 6s	0 to 6		
	0.1s to 10s	0 to 1		
	0.3s to 30	0 to 3	10s	
	0.6s to 60	0 to 6		
	1.8s to 180s	0 to 18		
	6s to 600s	0 to 60		
Step 2				Remarks
The set time is selected by turning the ③ Setting Knob.				Setting Examples: 1. When the Setting Knob ③ is set at 2.5, with Dial Selector ① 0 to 3 and Time Range Selector ② 1S selected, then the set time is 2.5 seconds. 2. When the Setting Knob ③ is set at 5.0, with Dial Selector ① 0 to 60 and Time Range Selector ② 10S selected, then the set time is 500 seconds.

Switches & Pilot Lights

Display Lights

Relays & Sockets

Timers

Terminal Blocks

Circuit Breakers

Instructions: Wiring Inputs

Inputs of GT3F

To avoid electric shock, do not touch the input signal terminal during power voltage application. Never apply the input signals to two or more GT3F timers using the same contact or transistor.

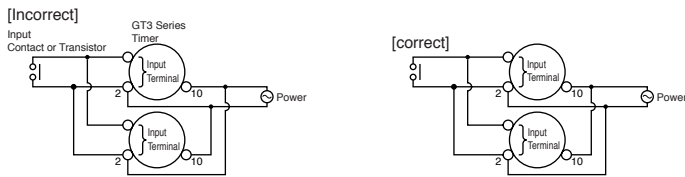

In a transistor circuit for controlling input signals, with its primary and secondary power circuits isolated, do not ground the secondary circuit.

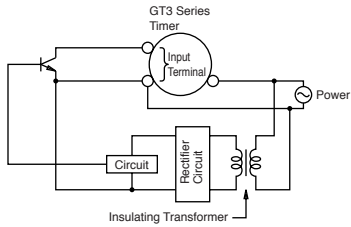

On the GT3F timers, connect the input signals to terminal No.1 and 4 only on the 8-pin type; connect the input signals to terminal No. 6 and 7 only on the 11-pin type. Never apply voltage to other terminals; otherwise, the internal circuit may be damaged.

Input signal lines must be made as short as possible and installed away from power cables and power lines. Use shielded wires or a separate conduit for input wiring.

The GT3F, consisting of a high-impedance circuit, may not be reset due to the influence of an inductive voltage or residual voltage caused by a leakage current. If not reset, connect an RC filter or bleeder resistor between power terminals so that the voltage between power terminals can be reduced to less than 15% of the rated voltage.

GT3S (Star-Delta) Timers

Star-Delta



Operation Mode	Rated Input Voltage	Time Range	Output	Contact	Part No.
					8-pin Type
Star-Delta	AF20: 100 to 240V AC (50/60Hz)	Star: 0.05 to 100 sec Star-Delta switching time: 0.05 sec 0.1 sec 0.25 sec 0.5 sec	250V AC/30V DC, 5A (resistive load)	Star: Delayed SPST-NO Delta: Delayed SPST-NO	GT3S-1AF20
				Star: Delayed SPST-NO Delta: Delayed SPST-NO Instantaneous: SPST-NO	GT3S-2AF20

Time Ranges

① Star Dial Selector		② Star-Delta Switching Time Selector
Dial	Time Range	Time
0-5	0.05 sec - 5 sec	0.05 sec
0-10	0.1 sec - 10 sec	0.1 sec
0-50	0.5 sec - 50 sec	0.25 sec
0-100	1 sec - 100 sec	0.5 sec

Contact Ratings

Contact Ratings		250V AC/30V DC, 5A (resistive load)
Life	Mechanical	20,000,000 operations minimum
	Electrical	100,000 operations minimum (rated load)

General Specifications

Operation System	Solid state CMOS circuitry	
Operation Type	Star-delta	
Time Range	Star side: 0.05 to 100 sec Star-delta switching time: 0.05, 0.1, 0.25, 0.5 sec	
Rated Operational Voltage	100 to 240V AC (50/60Hz)	
Operating Temperature	-10 to +50°C	
Storage Temperature	-30 to +80°C	
Operating Humidity	45 to 85% RH	
Voltage Tolerance	85 to 264V AC	
Repeat Error	±0.2%, ±10 msec	
Voltage Error	±0.2%, ±10 msec	
Temperature Error	±0.2%, ±10 msec	
Setting Error	±10% maximum	
Reset Time	500 msec maximum	
Insulation Resistance	100MΩ minimum	
Dielectric Strength	Between power and output terminals: 2,000V AC, 1 minute Between contacts of different poles: 2,000V AC, 1 minute Between contacts of the same pole: 750V AC, 1 minute	
Vibration Resistance	100 m/sec ² (Approx. 10G)	
Shock Resistance	Operating extremes: 100m/sec ² (Approx. 10G) Damage limits: 500m/sec ² (Approx. 50G)	
Power Consumption (Approx.)	Type GT3S-1	2.3VA (100V AC, 60Hz), 4.0VA (200V AC, 60Hz)
	Type GT3S-2	2.3VA (100V AC, 60Hz), 3.8VA (200V AC, 60Hz)

Switches & Pilot Lights

Display Lights

Relays & Sockets

Timers

Terminal Blocks

Circuit Breakers

Operation Charts

Product Series

Internal Connection and Terminal Arrangement

Operation Chart

GT3S-1
 Star: Delayed SPST-NO
 Delta: Delayed SPST-NO

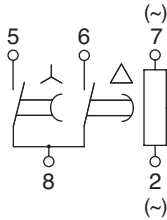

Item	Terminal No.	Operation
Power	2-7	[Power ON bar]
Star Delayed Contact	8-5 (NO)	[Star ON bar from T1 to T2]
Delta Delayed Contact	8-6 (NO)	[Delta ON bar from T2 to T3]
Indicator	Star	[Star ON bar from T1 to T2]
	Delta	[Delta ON bar from T2 to T3]
Set Time		[Timeline with T1, T2, T3 markers]

The star delayed contact goes on when power is turned on and goes off after a set time for the start contact (T_1). The delta delayed contact goes on after star-delta switching time (T_2) and goes off when power is turned off.
 T_1 = Star ON time (Set Time), T_2 = Star-delta switching time, T_3 = Delta ON time

GT3S-2
 Star: Delayed SPST-NO
 Delta: Delayed SPST-NO
 Instantaneous: SPST-NO

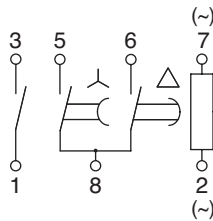

Item	Terminal No.	Operation
Power	2-7	[Power ON bar]
Star Delayed Contact	8-5 (NO)	[Star ON bar from T1 to T2]
Delta Delayed Contact	8-6 (NO)	[Delta ON bar from T2 to T3]
Instantaneous contact	3-1 (NO)	[Instantaneous ON bar from T1 to T3]
Indicator	Star	[Star ON bar from T1 to T2]
	Delta	[Delta ON bar from T2 to T3]
Set Time		[Timeline with T1, T2, T3 markers]

The star delayed contact goes on when power is turned on and goes off after a set time for the star contact (T_1). The delta delayed contact goes on after star-delta switching time (T_2) and goes off when power is turned off.
 The instantaneous contact goes on when power is turned on and goes off when power is turned off.
 T_1 = Star ON time (Set Time), T_2 = Star-delta switching time, T_3 = Delta ON time

GT3W Series – Dual Time Range Timers

Key features of the GT3W series include:

- Sequential start, sequential interval, on-delay, recycler, and interval ON timing functions
- 2 time settings in one timer
- 8 selectable operation modes on each model
- Mountable in sockets or flush panel
- Power and output status indicating LEDs
- Time ranges up to 300 hours

General Specifications

Operation System		Solid state CMOS Circuit	
Operation Type		Multi-Mode	
Time Range		1: 0.1sec to 6 hours, 3: 0.1sec to 300 hours	
Pollution Degree		2 (IE60664-1)	
Over Voltage Category		III (IE60664-1)	
Rated Operational Voltage	AF20	100-240V AC(50/60Hz)	
	AD24	24V AC(50/60Hz)/24V DC	
	D12	12V DC	
Voltage Tolerance	AF20	85-264V AC(50/60Hz)	
	AD24	20.4-26.4V AC(50/60Hz)/21.6-26.4V DC	
	D12	10.8-13.2V DC	
Disengaging Value of Input Voltage		Rated Voltage x10% minimum	
Range of Ambient Operating Temperature		-10 to +50°C (without freezing)	
Range of Ambient Storage and Transport Temperature		-30 to +75°C (without freezing)	
Range of Relative Humidity		35 to 85%RH (without condensation)	
Atmospheric Pressure		80kPa to 110kPa (Operating), 70kPa to 110kPa (Transport)	
Reset Time		60msec maximum	
Repeat Error		±0.2%, ±10msec*	
Voltage Error		±0.2%, ±10msec*	
Temperature Error		±0.6%, ±10msec*	
Setting Error		±10% maximum	
Insulation Resistance		100MΩ minimum (500V DC)	
Dielectric Strength		Between power and output terminals: 2000V AC, 1 minute Between contacts of different poles: 2000V AC, 1 minute Between contacts of the same pole: 750V AC, 1 minute	
Vibration Resistance		10 to 55Hz amplitude 0.75mm ² hours in each of 3 axes	
Shock Resistance		Operating extremes: 98m/sec ² (approx. 10G) Damage limits: 490m/sec ² (approx. 50G) 3 times in each of 3 axes	
Degree of Protection		IP40 (enclosure), IP20 (socket) (IEC60529)	
Power Consumption (Approx.)	AF20	100V AC/60Hz	2.3VA
		200V AC/60Hz	4.6VA
	AD24 (AC/DC)		1.8VA/0.9W
Mounting Position		Free	
Dimensions		40Hx 36W x 70 mm	
Weight (Approx.)		72g	

Contact Ratings

Allowable Contact Power	960VA/120W	
Allowable Voltage	250V AC/150V DC	
Allowable Current	5A	
Maximum permissible operating frequency	1800 cycles per hour	
Rated Load	1/8HP, 240V AC	
	3A, 240V AC (Resistive)	
	5A, 120V AC/30V DC (Resistive)	
Conditional Short Circuit	Fuse 5A, 250V	
Life	Electrical	100,000 op. minimum (Resistive)
	Mechanical	20,000,000 op. minimum

* For the value of the error against a preset time, whichever the largest applies.



Part Number List

Part Numbers

Mode of Operation	Output	Contact	Time Range*	Rated Voltage	Pin Configuration	New Part Numbers
A: Sequential Start B: On-delay with course and fine C: Recycler and instaneous D: Recycler outputs (OFF Start) E: Recycler outputs (ON Start) F: Interval ON G: Interval ON Delay H: Sequential Interval	3A, 240V AC	Delayed SPDT + Delayed SPDT	1: 0.1sec - 6 hours *(See Time Range Settings for details.)	100 to 240V AC (50/60Hz)	8 pin	GT3W-A11AF20N
					11 pin	GT3W-A11EAF20N
				24V AC/DC	8 pin	GT3W-A11AD24N
					11 pin	GT3W-A11EAD24N
	5A, 120V AC/30V DC (Resistive Load)		12V DC	8 pin	GT3W-A11D12N	
				11 pin	GT3W-A11ED12N	
			100 to 240V AC (50/60Hz)	8 pin	GT3W-A33AF20N	
			24V AC/DC		GT3W-A33AD24N	
		3: 0.1sec - 300 hours				



1. For timing diagrams and schematics, see page 836.
2. For socket and accessory part number information, see page 838.
3. 8- and 11-pin models differ only in the number of pins (extra pins are not used).
4. For the timing diagram overview, see page 794.
5. *For details on setting time ranges, see the instructions on page 837.

Time Range Table

Time Range Code: 1			Time Range Code: 3		
Time Range Selector	Scale	Time Range	Time Range Selector	Scale	Time Range
1S	0-1	0.1 sec - 1 sec	1S	0 - 3	0.1 sec - 3 sec
10S		0.3 sec - 10 sec	1M		3 sec - 3 min
10M		15 sec - 10 min	1H		3 min - 3 hours
1S	0 - 6	0.1 sec - 6 sec	1S	0 - 30	0.6 sec - 30 sec
10S		1 sec - 60 sec	1M		36 sec - 30 min
1M		6 sec - 6 min	1H		36min - 30 hours
10M		1 min - 60 min	10H		6 hours - 300 hours
1H		6 min - 6 hours			

Switches & Pilot Lights

Display Lights

Relays & Sockets

Timers

Terminal Blocks

Circuit Breakers

Timing Diagrams/Schematics

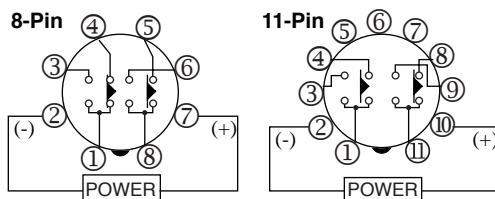

Mode	Operation Chart				Mode	Operation Chart			
A: Sequential Start	Item	Terminal No.	Operation	Description	E: Recycler outputs (ON Start)	Item	Terminal No.	Operation	Description
	Power	2-7	[Timing Diagram]			Power	2-7	[Timing Diagram]	
B: On-delay with course and fine	Item	Terminal No.	Operation	Description	F: Interval ON	Item	Terminal No.	Operation	Description
	Delayed Contact Ry1	1-4 (NC) 1-3 (NO)	[Timing Diagram]	ON after T1 + T2		Delayed Contact Ry1	1-4 (NC) 1-3 (NO)	[Timing Diagram]	ON during T1
C: Recycler and instantaneous	Item	Terminal No.	Operation	Description	G: Interval ON Delay	Item	Terminal No.	Operation	Description
	Delayed Contact Ry2	5-8 (NC) 6-8 (NO)	[Timing Diagram]	OFF during T1 ON during T2		Delayed Contact Ry2	5-8 (NC) 6-8 (NO)	[Timing Diagram]	ON after T1, during T2
D: Recycler outputs (OFF Start)	Item	Terminal No.	Operation	Description	H: Sequential Interval	Item	Terminal No.	Operation	Description
	Indicator	OUT1 OUT2	[Timing Diagram]			Indicator	OUT1 OUT2	[Timing Diagram]	

Switches & Pilot Lights

Display Lights

Relays & Sockets

Timers

Terminal Blocks

Circuit Breakers

Instructions: Setting GT3W Timer

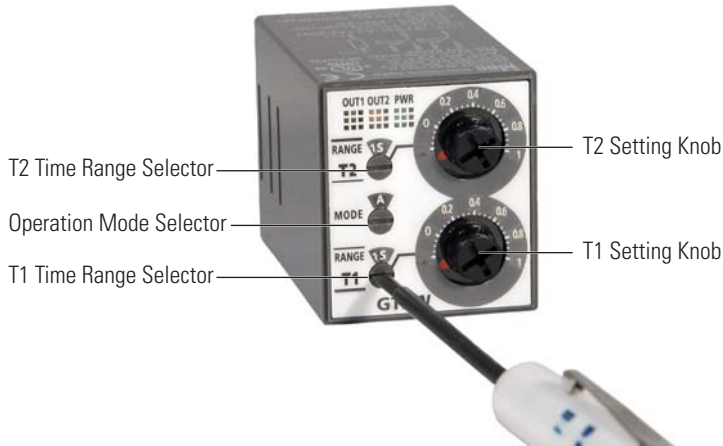

1. The switches should be securely turned using a flat screwdriver 4mm wide (maximum). Note that incorrect setting may cause malfunction. The switches, which do not turn infinitely, should not be turned beyond their limits.
2. Since changing the setting during timer operation may cause malfunction, turn power off before changing.

Safety Precautions

Special expertise is required to use Electronic Timers.

- All Electronic Timer modules are manufactured under IDEC's rigorous quality control system, but users must add a backup or fail safe provision to the control system when using the Electronic Timer in applications where heavy damage or personal injury may occur should the Electronic Timer fail.
- Install the Electronic Timer according to instructions described in this catalog.
- Make sure that the operating conditions are as described in the specifications. If you are uncertain about the specifications, contact IDEC in advance.
- In these directions, safety precautions are categorized in order of importance to Warning and Caution.

Warning

Warning notices are used to emphasize that improper operation may cause severe personal injury or death.

- Turn power off to the Electronic timer before starting installation, removal, Wiring, maintenance, and inspection on the Electronic Timer.
- Failure to turn power off may cause electrical shocks or fire hazard.
- Emergency stop and interlocking circuits must be configured outside the Electronic timer. If such a circuit is configured inside the Electronic Timer, failure of the Electronic timer may cause malfunction of the control system, or an accident.

Caution









Caution notices are used where inattention might cause personal injury or damage to equipment.

- The Electronic Timer is designed for installation in equipment. Do not install the Electronic Timer outside equipment.
- Install the Electronic Timer in environments described in the specifications. If the Electronic Timer is used in places where it will be subjected to high-temperature, high-humidity, condensation, corrosive gases, excessive vibrations, or excessive shocks, then electrical shocks, fire hazard, or malfunction could result.
- Use an IEC60127-approved fuse and circuit breaker on the power and output line outside the Electronic Timer.
- Do not disassemble, repair, or modify the Electronic Timer.
- When disposing of the Electronic Timer, do so as industrial waste.

**GT3 Series
Accessories**

DIN Rail Mounting Accessories

DIN Rail/Surface Mount Sockets and Hold-Down Springs

DIN Rail Mount Socket				Applicable Hold-Down Springs	
Style	Appearance	Use with Timers	Part No.	Appearance	Part No.
8-Pin Screw Terminal (dual tier)		GT3A-1, 2, 3 (8-pin) GT3D-1, 2, 3 (8-pin) GT3F-1, 2 (8-pin) GT3W (8-pin) GT3S	SR2P-05		SFA-203
11-Pin Screw Terminal (dual tier)		GT3A-1, 2, 3 (11-pin) GT3A-4, 5, 6 GT3D-1, 2, 3 (11-pin) GT3D-4, 8 GT3F-1, 2 (11-pin) GT3W (11-pin)	SR3P-05		
8-Pin Fingersafe Socket		GT3A-1, 2, 3 (8-pin) GT3D-1, 2, 3 (8-pin) GT3F-1, 2 (8-pin) GT3W (8-pin) GT3S	SR2P-05C		
11-Pin Fingersafe Socket		GT3A-1, 2, 3 (11-pin) GT3A-4, 5, 6 GT3D-1, 2, 3 (11-pin) GT3D-4, 8 GT3F-1, 2 (11-pin) GT3W (11-pin)	SR3P-05C		
8-Pin Screw Terminal		GT3A-1, 2, 3 (8-pin) GT3D-1, 2, 3 (8-pin) GT3F-1, 2 (8-pin) GT3W (8-pin) GT3S	SR2P-06		SFA-202
11-Pin Screw Terminal		GT3A-1, 2, 3 (11-pin) GT3A-4, 5, 6 GT3D-1, 2, 3 (11-pin) GT3D-4, 8 GT3F-1, 2 (11-pin) GT3W (11-pin)	SR3P-06		
DIN Mounting Rail Length 1000mm		—	BNDN1000		

**Installation of Hold-Down Springs
DIN Rail Mount Socket**

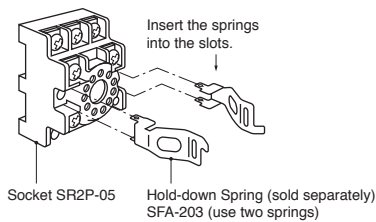
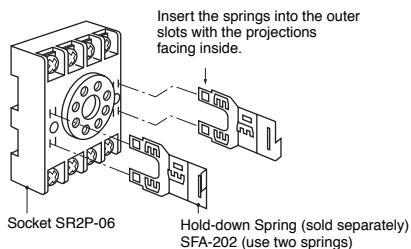

Panel Mount Socket

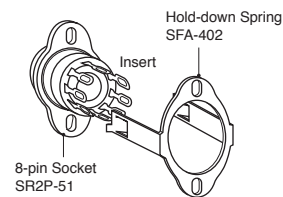

Switches & Pilot Lights

Display Lights

Relays & Sockets



Timers

Terminal Blocks

Circuit Breakers

Panel Mounting Accessories

Panel Mount Sockets and Hold-Down Springs

Panel Mount Socket				Applicable HD Springs	
Style	Appearance	Use with Timers	Part No.	Appearance	Part No.
8-Pin Solder Terminal		GT3A- (8-pin) GT3D- (8-pin) GT3W- (8-pin) GT3F- (8-pin) GT3S	SR2P-51		SFA-402
11-Pin Solder Terminal		GT3A- (11-pin) GT3D- (11-pin) GT3W- (11-pin) GT3F- (11-pin)	SR3P-51		





Switches & Pilot Lights

Display Lights



For information on installing the hold-down springs, see page 838.

Flush Panel Mount Adapter and Sockets that use an Adapter

Accessory	Description	Appearance	Use with Timers	Part No.
Panel Mount Adapter	Adaptor for flush panel mounting GT3 timers		All GT3 timers	RTB-G01
Sockets for use with Panel Mount Adapter	8-pin screw terminal		All 8-pin timers	SR6P-M08G
	11-pin screw terminal		(Shown: SR6P-M08G for Wiring Socket Adapter)	All 11-pin timers
	8-pin solder terminal		All 8-pin timers	SR6P-S08
	11-pin solder terminal		All 11-pin timers	SR6P-S11

Relays & Sockets

Timers

Terminal Blocks

Circuit Breakers



No hold down springs are available for flush panel mounting.

Instructions: Wiring Inputs for GT3 Series

Inputs Inputs

To avoid electric shock, do not touch the input signal terminal during power voltage application.

When connecting the input signal terminals of two or more GT3A timers to the same contact or transistor, the input terminals of the same number should be connected. (Connect Terminals No.2 in common.)

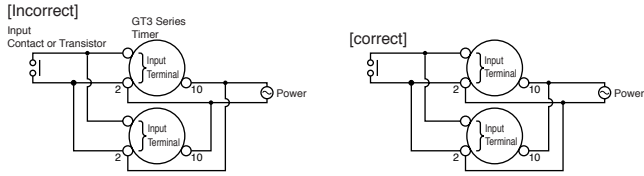

In a transistor circuit for controlling input signals, with its primary and secondary power circuits isolated, do not ground the secondary circuit.

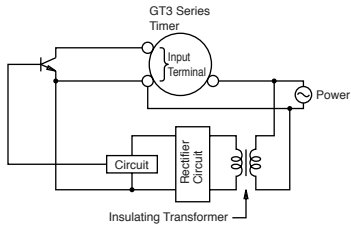

Connect the input signal terminals of the GT3A timers to Terminal No.2 only. Never apply voltage to other terminals; otherwise, the internal circuit may be damaged.

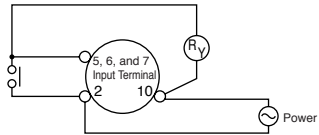

Input signal lines must be made as short as possible and installed away from power cables and power lines. Use shielded wires or a separate conduit for input wiring.

Switches & Pilot Lights

Display Lights

Relays & Sockets

Timers

Terminal Blocks

Circuit Breakers

Inputs Instructions, continued

For contact input, use gold-plated contacts to make sure that the residual voltage is less than 1V when the contacts are closed.

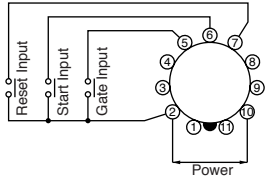

For transistor input, use transistors with the following specifications; VCE = 40V, VCES = 1V or less, IC = 50 mA or more, and ICBO = 50μA or less. The resistance should be less than 1kΩ when the transistor is on. When the output transistor switches on, a signal is input to the timer.

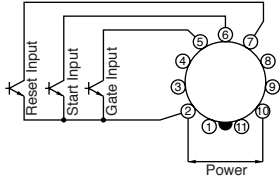

Inputs: GT3A-1, -2, -3

Transistor output equipment such as proximity switches and photoelectric switches can input signals if they are voltage/current output type, with power voltage ranges from 18 to 30V and have 1V. When the signal voltage switches from H to L, a signal is input to the timer

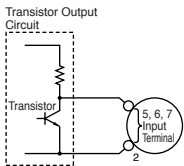

Inputs: GT3A-4, -5, -6

Start Input	The start input initiates a time-delay operation and controls output status.	No-voltage contact inputs and NPN open collector transistor inputs are applicable. 24V DC, 1mA maximum Input response time: 50msec maximum
Reset Input	When the reset input is activated, the time is reset, and contacts return to original state.	
Gate Input	The time-delay operation is suspended while the gate input is on (pause).	

Dimensions

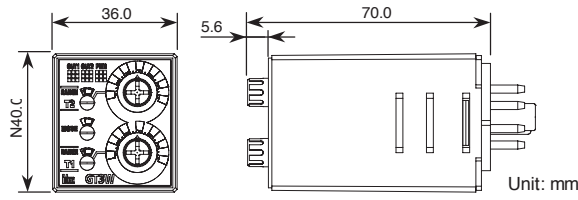

NOTE: GT3W series are UL Listed when used in combination with following IDEC's sockets:
 GT3W-A11, A33: SR2P-06* pin type socket.
 GT3W-A11E: SR3P-05* pin type socket.
 (*-May be followed by A,B,C or U)
 The socket to be used with these timers are rated:
 -Conductor Temperature Rating 60°C min.
 -Use 14AWG max.(2mm²max.) Copper conductors only
 -Terminal Torque 1.0 to 1.3 N-m

Analog GT3 Timer, 8-Pin with SR2P-06

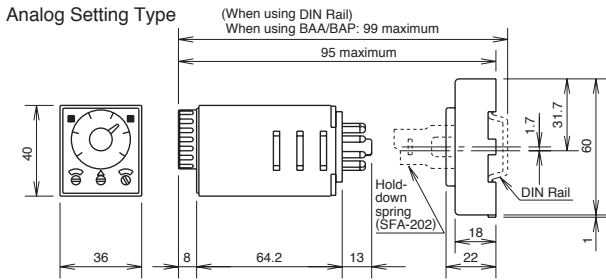

Analog GT3 Timer, 11-Pin with SR3P-06

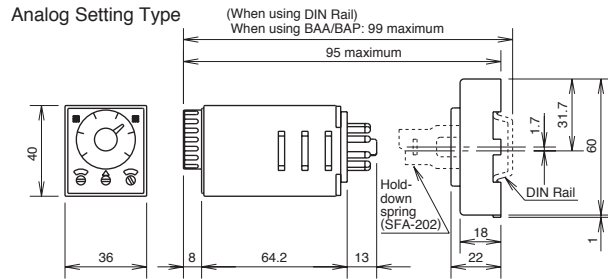

Digital GT3 Timer, 8-Pin with SR2P-06

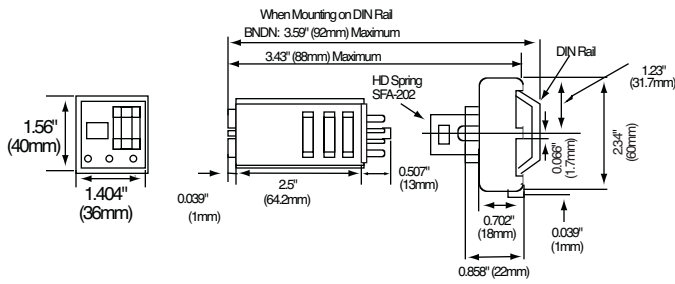

Digital GT3 Timer, 11-Pin with SR3P-06

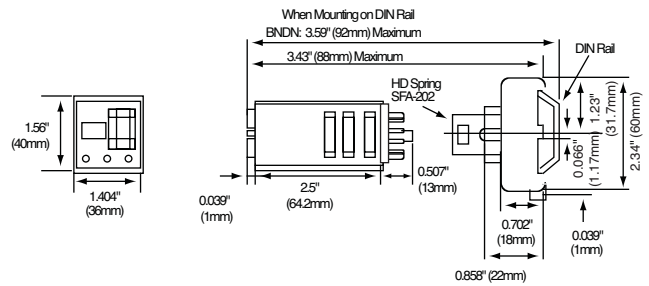

Analog GT3 Timer, 11-Pin with SR3P-05

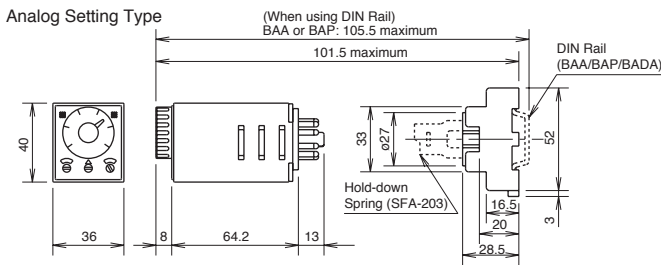

Digital GT3 Timer, 11-Pin with SR3P-05

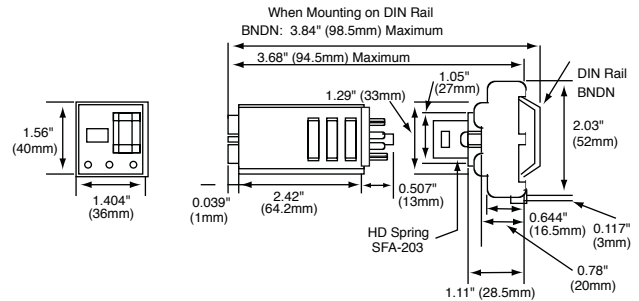

Switches & Pilot Lights

Display Lights

Relays & Sockets

Timers

Terminal Blocks

Circuit Breakers

Panel Mount Adapter

Analog GT3 Timer, 8-Pin and 11-Pin with SR6P-S08 or SR6P-S11

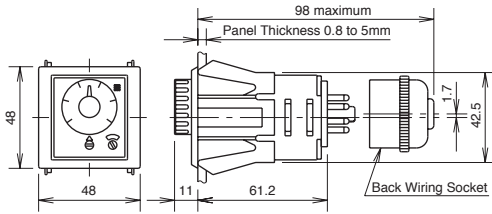

Digital GT3 Timer, 8-Pin and 11-Pin with SR6P-S08 or SR6P-S11

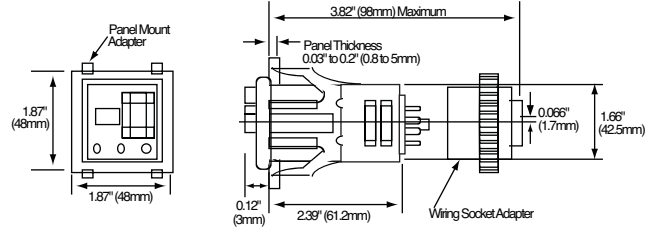

Mounting Hole Layout

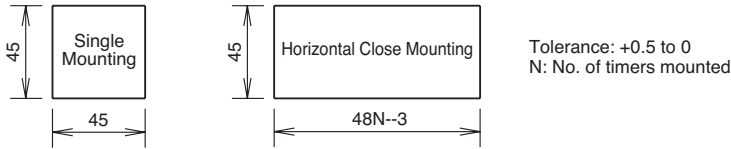

Analog and Digital GT3 Timer, 8-Pin with SR6P-M08G

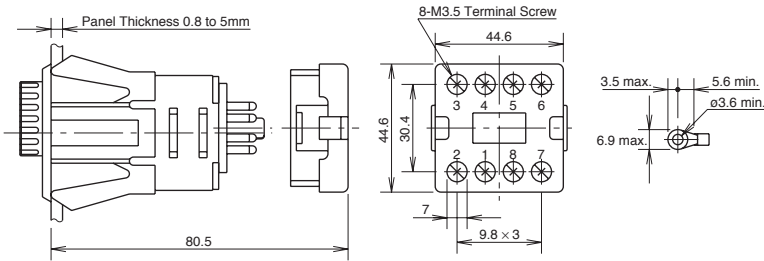

Analog and Digital GT3 Timer, 11-Pin with SR6P-M11G

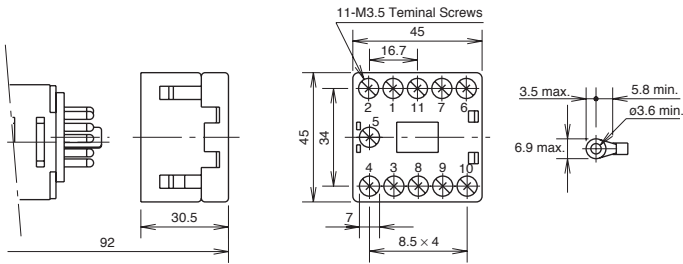

GE1A Series – ON Delay Timers

Single Function

Key features of the GE1A series include:

- DPDT or SPDT + instantaneous SPDT
- 8-pin, octal base
- 8 time ranges
- Repeat error $\pm 0.2\%$ maximum
- Large, clear knob for easy setting
- Instant monitoring of operational status by LED indicators



UL, c-UL Listed
File No. E55996



Specifications

Rated Operating Voltage	24V AC/DC 100 to 120V AC 220 to 240V AC	
Voltage Tolerance	AC: 85 to 110% DC: 90 to 110%	
Contact Rating	240V AC/5A 24V DC/5A	
Contact Form	DPDT or SPDT+ instantaneous SPDT	
Repeat Error	$\pm 0.2\% \pm 10\text{msec}$ maximum	
Voltage Error	$\pm 0.5\% \pm 10\text{msec}$ maximum	
Temperature Error	$\pm 3\%$ maximum	
Setting Error	$\pm 10\%$ maximum	
Reset Time	0.1 sec maximum	
Insulation Resistance	100M Ω minimum (500V DC megger)	
Dielectric Strength	Between power and output terminals: 1,500V AC, 1 minute Between contact circuits: 750V AC, 1 minute	
Vibration Resistance	Damage limits: Amplitude 0.75mm, 10 to 55 Hz Operating extremes: Amplitude 0.5mm, 10 to 55 Hz	
Shock Resistance	Damage limits: 500m/s ² (Approx. 50G)	
Power Consumption	GE1A-B	24V AC type: 1.6 VA
		24V DC type: 1.0W
		110V AC type: 3.8 VA
	GE1A-C	220V AC type: 7.7 VA
		24V AC type: 2.0 VA
		24V DC type: 0.8W
	110V AC type: 3.5 VA	
	220V AC type: 8.0 VA	
Electrical Life	100,000 operations minimum (at full rated load)	
Mechanical Life	10,000,000 operations minimum	
Operating Temperature	-10 to +55°C (without freezing)	
Operating Humidity	35 to 85% RH (without freezing)	

Switches & Pilot Lights

Display Lights

Relays & Sockets

Timers

Terminal Blocks

Circuit Breakers

Part Numbering List

Mode of Operation	Contact	Output	Rated Voltage	Time Range	Complete Part Number	
ON-Delay	Delayed SPDT + Instantaneous SPDT	24V DC/120V AC, 5A 240V AC, 5A	24V AC/DC	0.1s to 10m	GE1A-B10MAD24	
			110-120V AC		GE1A-B10MA110	
			220-240V AC		GE1A-B10MA220	
			24V AC/DC	0.1m to 10h	GE1A-B10HAD24	
			110-120V AC		GE1A-B10HA110	
			220-240V AC		GE1A-B10HA220	
	Delayed DPDT			24V AC/DC	0.1s to 10m	GE1A-C10MAD24
				110-120V AC		GE1A-C10MA110
				220-240V AC		GE1A-C10MA220
				24V AC/DC	0.1m to 10h	GE1A-C10HAD24
				110-120V AC		GE1A-C10HA110
				220-240V AC		GE1A-C10HA220

Switches & Pilot Lights

Display Lights

Timing Diagrams/Schematics

GE1A-B
Delayed SPDT + Instantaneous SPDT

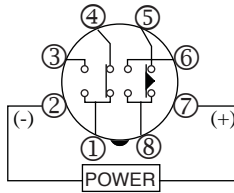

GE1A-C
Delayed DPDT

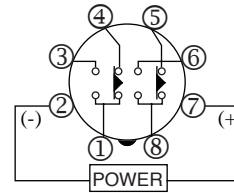

Operation Mode Selection

Relays & Sockets

ON-Delay 1

MODE

A

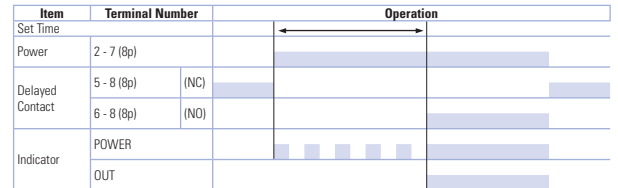
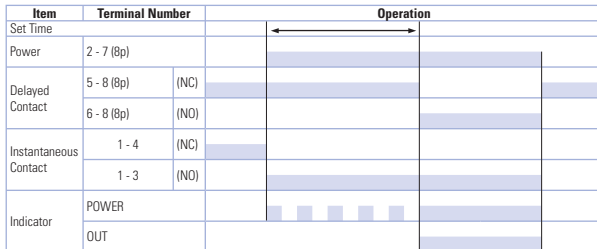

Timers

Terminal Blocks

Circuit Breakers

Accessories

Mounting Accessories & Sockets

	Style	Appearance	Part No.	
Switches & Pilot Lights	8-Pin Screw Terminal (dual tier)		SR2P-05	
	DIN Rail/Surface Mounting Accessories	8-Pin Fingersafe Socket		SR2P-05C
		8-Pin Screw Terminal		SR2P-06
Display Lights	DIN Mounting Rail Length 1000mm		BNDN1000	
Relays & Sockets	8-Pin Solder Terminal		SR2P-51	
	Panel Mounting Accessories	Screw Terminal Socket		SR6P-M08G
Terminal Blocks		Panel Mount Adapter		GE9Z-AD

Other Accessories

	Style	Appearance	Part No.
Circuit Breakers	Dust Cover		GE9Z-C48

Dimensions

GE1A Timer

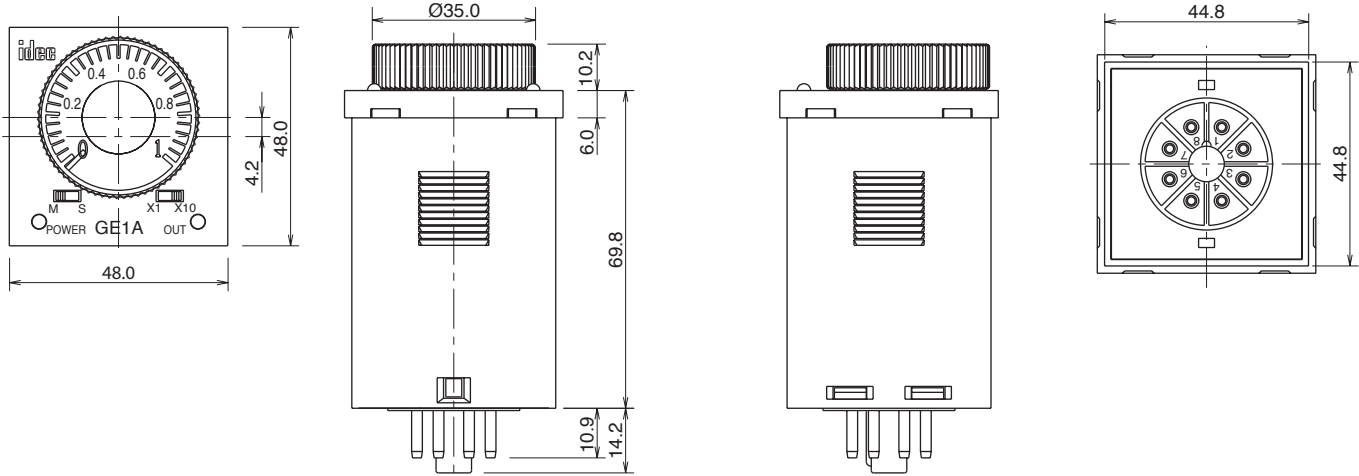

GE1A Timer Panel Cutout

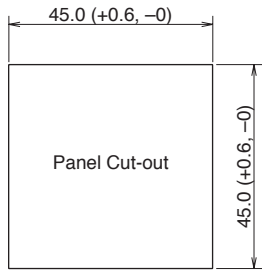

8-Pin SR2P-05

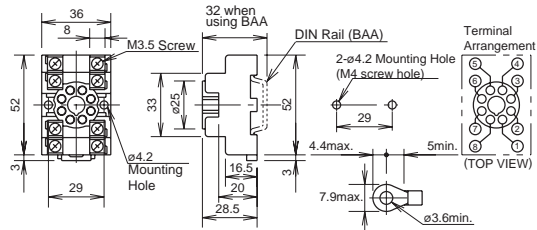

8-Pin SR2P-06

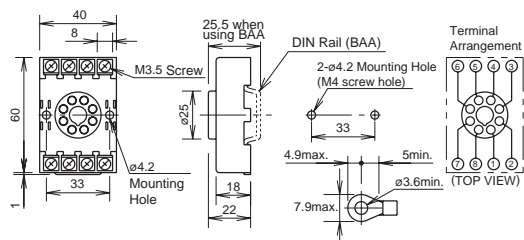

GT5P Series – ON Delay Timers

Key features of the GT5P series include:

- SPDT, 5A contacts
- 8-pin, octal base
- 9 time ranges
- Repeat error ±0.2% maximum
- Control settings by hand or screwdriver
- Power ON and timing out LED indicators
- Uses the same sockets and hold down clips as IDEC's RR2P 8-pin relays



UL Recognized
File No. E55996



CSA Certified
File No. LR66809



Specifications

Rated Operating Voltage	100 to 120V AC (50/60Hz) 200 to 240V AC (50/60Hz) 24V AC/DC 12V DC
Voltage Tolerance	AC type: ±15% DC type: ±10% (ripple 10% maximum)
Contact Rating	Resistive load 120V AC/24V DC, 5A 240V AC, 3A
	Inductive load 240V AC, 0.8A 120V AC, 1.4A 24V DC, 1.7A
Allowable Contact Power (resistive load)	960VA AC 120W DC
Contact Form	SPDT
Voltage	250V AC, 150V DC
Repeat Error	±0.2% ±10msec
Voltage Error	±0.5% ±10msec
Temperature Error	±3% maximum (over -10 to 50°C, reference temperature 20°C)
Setting Error	±10% maximum
Reset Time	When turning power off after time up: 0.1 sec maximum When turning power off before time up: 1 sec maximum
Insulation Resistance	100MΩ minimum
Dielectric Strength	2000V AC, 1 minute (except between contacts of the same pole)
Vibration Resistance	100N (approximate 10G)
Shock Resistance	Operating extremes: 100N (approximate 10G) Damage limits: 500N (approximate 50G)
Power Consumption	100V AC type: 1.5VA (at 50Hz) 200V AC type: 1.6VA (at 50Hz) 24V DC type: 0.9W
Electrical Life	100,000 operations minimum (at rated load)
Mechanical Life	20,000,000 operations minimum
Operating Temperature	-10 to +50°C
Operating Humidity	45 to 85% RH

1. Inductive load (reference), cos φ = 0.3 to 0.4 or L/R = 15msec.
2. Minimum applicable load: 5VDC/10mA (reference).

Switches & Pilot Lights
Display Lights
Relays & Sockets
Timers
Terminal Blocks
Circuit Breakers

Part Numbering List

Mode of Operation	Contact	Output	Rated Voltage	Time Range	Complete Part No.
ON-Delay	SPDT	24V DC/120V AC, 5A 240V AC, 3A	100 to 120V AC	1S	—
				3S	GT5P-N3SA100
				6S	—
				10S	GT5P-N10SA100
				30S	GT5P-N30SA100
				60S	GT5P-N60SA100
				3M	GT5P-N3MA100
				6M	GT5P-N6MA100
				10M	GT5P-N10MA100
			200 to 240V AC	1S	GT5P-N1SA200
				3S	—
				6S	GT5P-N6SA200
				10S	GT5P-N10SA200
				30S	GT5P-N30SA200
				60S	GT5P-N60SA200
				3M	GT5P-N3MA200
				6M	GT5P-N6MA200
				10M	GT5P-N10MA200
			24V AC/DC	1S	GT5P-N1SAD24
				3S	—
				6S	GT5P-N6SAD24
				10S	GT5P-N10SAD24
				30S	—
				60S	GT5P-N60SAD24
				3M	—
				6M	GT5P-N6MAD24
				10M	GT5P-N10MAD24
			12V DC	1S	—
				3S	—
				6S	—
				10S	GT5P-N10SD12
				30S	GT5P-N30SD12
				60S	GT5P-N60SD12
				3M	—
				6M	—
				10M	GT5P-N10MD12

For sockets and accessories, see page 851.

Switches & Pilot Lights

Display Lights

Relays & Sockets

Timers

Terminal Blocks

Circuit Breakers

Timing Diagram/Schematic/Electrical Life Curves

Switches & Pilot Lights

Display Lights

Relays & Sockets

Timers

Terminal Blocks

Circuit Breakers

SPDT

Operation Mode

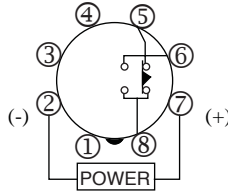

Do not apply voltage to terminals 1, 3, and 4.

ON-Delay

Item	Terminal Number	Operation
Set Time		← Operation →
Power	2 - 7 (8p)	[Bar chart showing power pulse]
Delayed Contact	5 - 8 (8p) (NC)	[Bar chart showing delayed NC contact]
	6 - 8 (8p) (NO)	[Bar chart showing delayed NO contact]
Indicator	POWER	[Bar chart showing power indicator]
	OUT	[Bar chart showing output indicator]

Electrical Life Curves

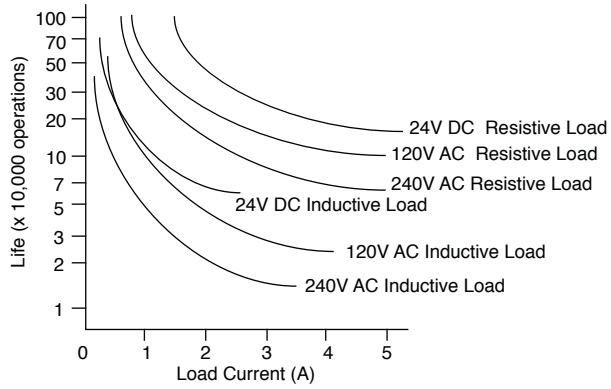

Accessories
Mounting

Mounting Accessories and Sockets					Applicable Hold-Down Springs	
	Style	Appearance	Use with Timers	Part No.	Appearance	Part No.
DIN Rail/ Surface Mounting Accessories	8-Pin Screw Terminal (dual tier)		GT5P	SR2P-05		SFA-203
	8-Pin Fingersafe Socket		GT5P	SR2P-05C		
	8-Pin Screw Terminal		GT5P	SR2P-06		SFA-202
	DIN Mounting Rail Length 1000mm		—	BNDN1000		
Part Numbers: Mounting Accessories and Sockets					Applicable Hold-Down Springs	
Mounting Accessories	8-Pin Solder Terminal			SR2P-51		SFA-402

Installation of Hold-Down Springs
DIN Rail Mount Socket

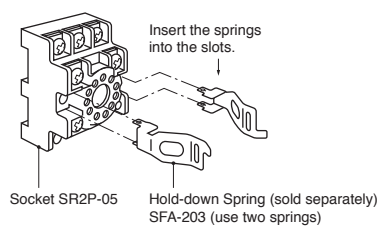
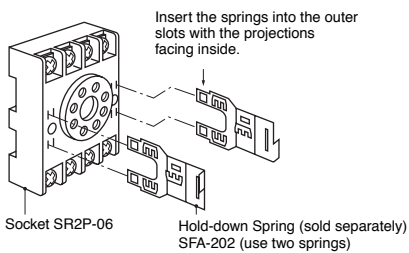

Panel Mount Socket

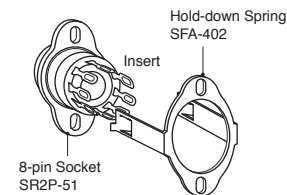

Switches & Pilot Lights

Display Lights

Relays & Sockets

Timers

Terminal Blocks

Circuit Breakers

Dimensions

GT5P Timer, 8-Pin with SR2P-05

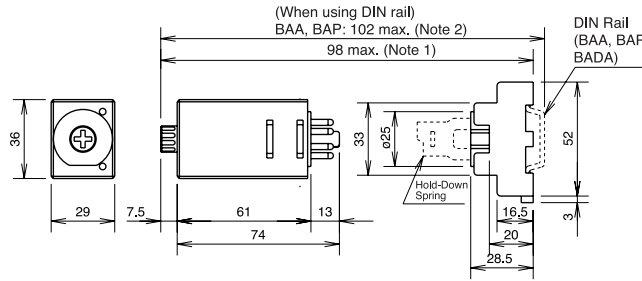

GT5P Timer, 8-Pin with SR2P-06

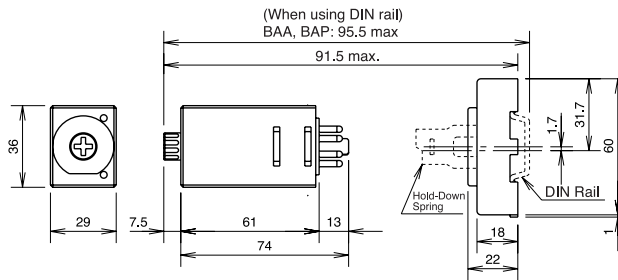

GT5Y Series – ON Delay Timers

Key features of the GT5Y series include:

- 4PDT, 3A or DPDT, 5A contacts
- 4 time ranges
- Repeat error $\pm 0.2\%$ maximum
- Control settings by hand or screwdriver
- Power ON and timing out LED indicators
- Uses the same sockets and hold-down clips as IDEC's RY4S and RU series relays



UL, c-UL Listed
File No. E55996

Specifications

		GT5Y-2	GT5Y-4
Rated Operating Voltage		100 to 120V AC (50/60Hz) 200 to 240V AC (50/60Hz) 24V DC 24V AC 12V DC	
Contact Form		DPDT	4PDT
Rated Load	Resistive Load	220V AC, 5A 30V DC, 5A	220V AC, 3A 30V DC, 3A
	Inductive Load	220V AC, 2A 30V DC, 2.5A	220V AC, 0.8A 30V DC, 1.5A
Allowable Contact Power	Resistive Load	1100VA AC 150W DC	660VA AC 90W DC
	Inductive Load Cos $\phi = 0.3$ L/R = 7msec	440VA AC 75W DC	176VA AC 45W DC
Allowable Voltage		250V AC, 125V DC	
Allowable Current		5A	3A
Temperature Error		$\pm 3\%$ maximum (over -10 to 50°C , reference temperature 20°C)	
Setting Error		$\pm 10\%$ maximum	
Reset Time		When turning power off after time up: 0.1 second maximum When turning power off before time up: 1 second maximum	
Insulation Resistance		100M Ω minimum	
Dielectric Strength		2,000V AC, 1 minute (except between contacts of the same pole)	
Vibration Resistance		100N (approximate 10G)	
Shock Resistance		Operating extremes: 100N (approximate 10G) Damage limits: 500N (approximate 50G)	
Power Consumption		100V AC type: 1.5VA (at 50Hz) 200V AC type: 1.6VA (at 50Hz) 24V DC type: 0.9W	
Electrical Life		500,000 operations minimum (220V AC, 5A)	200,000 operations minimum (110V AC, 3A)
Mechanical Life		50,000,000 operations minimum	
Operating Temperature		-10 to $+50^\circ\text{C}$	
Operating Humidity		45 to 85% RH	



1. Minimum applicable load: GT5Y-2: 5V DC, 20mA (reference value); GT5Y-4: 5V DC, 10mA (reference value).
2. Inductive load: cos $\phi = 0.3$, L/R=7msec.

Part Numbering List

Switches & Pilot Lights

Display Lights

Relays & Sockets

Timers

Mode of Operation	Contact	Output	Rated Voltage	Time Range	Complete Part No.			
ON-Delay	DPDT	220V AC/ 30V DC, 5A	100 to 120V AC	1S/10S/1M/10M	GT5Y-2SN1A100			
				3S/30S/3M/30M	GT5Y-2SN3A100			
				6S/60S/6M/60M	GT5Y-2SN6A100			
			200 to 240V AC	1S/10S/1M/10M	GT5Y-2SN1A200			
				3S/30S/3M/30M	GT5Y-2SN3A200			
				6S/60S/6M/60M	GT5Y-2SN6A200			
			12V DC	1S/10S/1M/10M	GT5Y-2SN1D12			
				3S/30S/3M/30M	GT5Y-2SN3D12			
				6S/60S/6M/60M	GT5Y-2SN6D12			
			24V DC	1S/10S/1M/10M	GT5Y-2SN1D24			
				3S/30S/3M/30M	GT5Y-2SN3D24			
				6S/60S/6M/60M	GT5Y-2SN6D24			
			24V AC	1S/10S/1M/10M	GT5Y-2SN1A24			
				3S/30S/3M/30M	GT5Y-2SN3A24			
				6S/60S/6M/60M	GT5Y-2SN6A24			
				4PDT	220V AC/30V DC, 3A	100 to 120V AC	1S/10S/1M/10M	GT5Y-4SN1A100
							3S/30S/3M/30M	GT5Y-4SN3A100
							6S/60S/6M/60M	GT5Y-4SN6A100
200 to 240V AC	1S/10S/1M/10M	GT5Y-4SN1A200						
	3S/30S/3M/30M	GT5Y-4SN3A200						
	6S/60S/6M/60M	GT5Y-4SN6A200						
12V DC	1S/10S/1M/10M	—						
	3S/30S/3M/30M	GT5Y-4SN3D12						
	6S/60S/6M/60M	—						
24V DC	1S/10S/1M/10M	GT5Y-4SN1D24						
	3S/30S/3M/30M	GT5Y-4SN3D24						
	6S/60S/6M/60M	GT5Y-4SN6D24						
24V AC	1S/10S/1M/10M	GT5Y-4SN1A24						
	3S/30S/3M/30M	GT5Y-4SN3A24						
	6S/60S/6M/60M	GT5Y-4SN6A24						



For sockets and accessories, see page 856.

Terminal Blocks

Circuit Breakers





Timing Ranges

Code	Scale	Time Range Indication		Time Range
1S	0 to 10	x 0.1	S	0.1 second to 1 second
10S		x 1	S	0.2 second to 10 seconds
1M		x 0.1	M	1.2 seconds to 1 minute
10M		x 1	M	12 seconds to 10 minutes
3S	0 to 3	x 1	S	0.1 second to 3 seconds
30S		x 10	S	0.5 second to 30 seconds
3M		x 1	M	3 seconds to 3 minutes
30M		x 10	M	30 seconds to 30 minutes
6S	0 to 6	x 1	S	0.1 second to 6 seconds
60S		x 10	S	1 second to 60 seconds
6M		x 1	M	6 seconds to 6 minutes
60M		x 10	M	1 minute to 60 minutes

Accessories

DIN Rail Mounting Accessories

DIN Rail/Surface Mount Sockets and Hold-Down Springs

DIN Rail Mount Socket			Applicable Hold-Down Springs	
Style	Appearance	Part No.	Appearance	Part No.
14-Blade Screw Terminal		SY4S-05		SFA-202
14-Blade Screw Terminal (fingersafe)		SY4S-05C		
DIN Mounting Rail Length 1000mm		BNDN1000		



Panel Mounting Accessories

Part Numbers: Panel Mount Socket and Hold-Down Springs

Panel Mount Socket			Applicable Hold-Down Springs	
Style	Appearance	Part No.	Appearance	Part No.
14-Blade Solder Terminal		SY4S-51		SFA-302

PCB Mounting Accessories

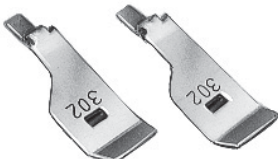
Part Numbers: PCB Mount Sockets with Applicable Hold-Down Springs

PCB Mount Socket			Applicable Hold-Down Springs	
Style	Appearance	Part No.	Appearance	Part No.
14 Blade, PCB Terminal		SY4S-61		SFA-302
14 Blade, PCB Terminal		SY4S-62		SY4S-02F1

Switches & Pilot Lights

Display Lights

Relays & Sockets

Timers

Terminal Blocks

Circuit Breakers

Dimensions

GT5Y Timer, Blade with SY4S-05

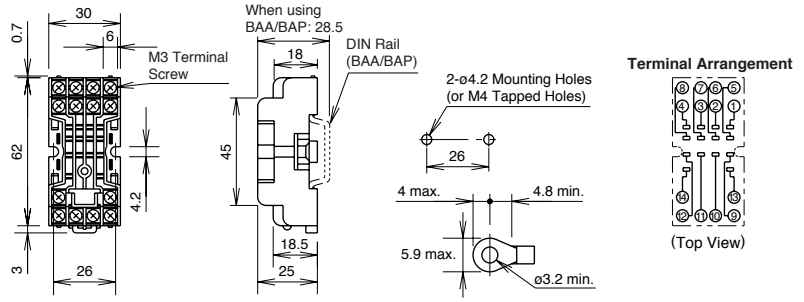
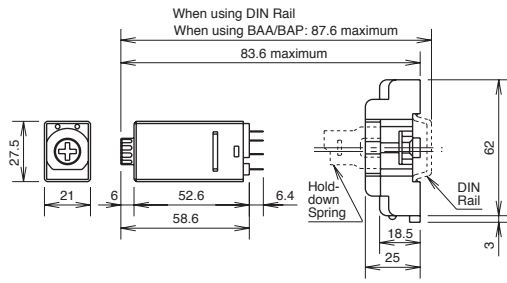

Switches & Pilot Lights

Display Lights

Relays & Sockets

Timers

Terminal Blocks

Circuit Breakers

General Instructions for All Timer Series

Switches & Pilot Lights

Load Current

With inductive, capacitive, and incandescent lamp loads, inrush current more than 10 times the rated current may cause welded contacts and other undesired effects. The inrush current and steady-state current must be taken into consideration when specifying a timer.

Contact Protection

Switching an inductive load generates a counter-electromotive force (back EMF) in the coil. The back EMF will cause arcing, which may shorten the contact life and cause imperfect contact. Application of a protection circuit is recommended to safeguard the contacts.

Temperature and Humidity

Use the timer within the operating temperature and operating humidity ranges and prevent freezing or condensation. After the timer has been stored below its operating temperature, leave the timer at room temperature for a sufficient period of time to allow it to return to operating temperatures before use.

Environment

Avoid contact between the timer and sulfurous or ammonia gases, organic solvents (alcohol, benzine, thinner, etc.), strong alkaline substances, or strong acids. Do not use the timer in an environment where such substances are prevalent. Do not allow water to run or splash on the timer.

Display Lights

Relays & Sockets

Vibration and Shock

Excessive vibration or shocks can cause the output contacts to bounce, the timer should be used only within the operating extremes for vibration and shock resistance. In applications with significant vibration or shock, use of hold down springs or clips is recommended to secure a timer to its socket.

Time Setting

The time range is calibrated at its maximum time scale; so it is desirable to use the timer at a setting as close to its maximum time scale as possible. For a more accurate time delay, adjust the control knob by measuring the operating time with a watch before application.

Input Contacts

Use mechanical contact switch or relay to supply power to the timer. When driving the timer with a solid-state output device (such as a two-wire proximity switch, photoelectric switch, or solid-state relay), malfunction may be caused by leakage current from the solid-state device. Since AC types comprise a capacitive load, the SSR dielectric strength should be two or more times the power voltage when switching the timer power using an SSR.

Generally, it is desirable to use mechanical contacts whenever possible to apply power to a timer or its signal inputs. When using solid state devices, be cautious of inrushes and back-EMF that may exceed the ratings on such devices. Some timers are specially designed so that signal inputs switch at a lower voltage than is used to power the timer (models designated as "B" type).

Timing Accuracy Formulas

Timing accuracies are calculated from the following formulas:

$$\text{Repeat Error} = \pm \frac{1 \times \text{Maximum Measured Value} - \text{Minimum Measured Value} \times 100\%}{2 \text{ Maximum Scale Value}}$$

$$\text{Voltage Error} = \pm \frac{T_v - T_r \times 100\%}{T_r}$$

T_v: Average of measured values at voltage V
T_r: Average of measured values at the rated voltage

$$\text{Temperature Error} = \pm \frac{T_t - T_{20} \times 100\%}{T_{20}}$$

T_t: Average of measured values at °C
T₂₀: Average of measured values at 20°C

$$\text{Setting Error} = \pm \frac{\text{Average of Measured Values} - \text{Set Value} \times 100\%}{\text{Maximum Scale Value}}$$

Timers

Terminal Blocks

Circuit Breakers