

OPERATING MANUAL

AIR-FUEL CONTROLLER EPC-100E

FORM EPC-100E OM 5-06



WARNING: DEVIATION FROM THESE INSTRUCTIONS MAY LEAD TO IMPROPER OPERATION OF THE ENGINE WHICH COULD CAUSE PERSONAL INJURY TO OPERATORS OR OTHER NEARBY PERSONNEL.

1.0 SYSTEM DESCRIPTION

- 1.1** The Altronic EPC-100E is an air/fuel ratio controller for use on carbureted gas engines. The controller utilizes microprocessor technology, allowing a high level of sophistication in control strategy, ease of programming and diagnostic capability. The EPC-100E is designed for use on engines operating at or near a stoichiometric air/fuel ratio (λ .95 - 1.05) and is ideally suited for application with 3-way catalytic converters.
- 1.2** An oxygen sensor is used in the exhaust stream to sense O₂ content; a thermocouple input signals when proper temperatures have been reached to allow for accurate sensor operation. A fuel/control valve installed in the fuel line to the carburetor is precisely adjusted by a stepper-motor under microprocessor control to maintain the correct O₂ content in the exhaust. The desired air/fuel ratio can be easily adjusted by changing the control target voltages through the sealed membrane keypad or through the use of a PC.
- 1.3** The EPC-100E has an alphanumeric LCD display showing the target voltage, sensor voltage, operating temperature, stepper motor position and diagnostic information.
- 1.4** Power requirement is 24 (10–30) VDC, 1 amp. In remote areas, power can be provided by the Altronic 24 VDC Alternator Power Package. Refer to Altronic Form ALT.
- 1.5** The EPC-100E also incorporates thermocouple inputs and a dedicated output for implementation of catalyst over-temperature protection.

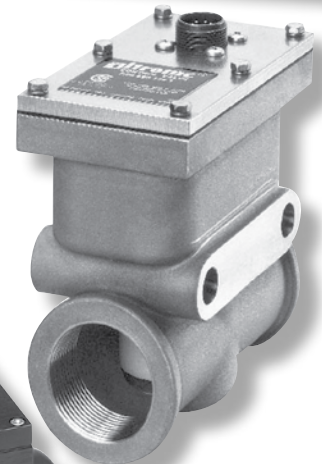

EPC-100E AIR-FUEL CONTROLLER

2.0 SYSTEM COMPONENTS

2.1 One part from each group below is required for each installation:

PART NO.	DESCRIPTION	QUANTITY REQUIRED
EPC-100E	Air/fuel controller	1 per engine—single bank
690154-1	Control Valve, standard 1.5" NPT	1 per carburetor
690154-2	Control Valve, low HP 1.5" NPT	
690154-5	Control Valve, very low HP 1.5" NPT	
690220-1	Control Valve, butterfly 2.0" NPT	
690225-1	Control Valve, butterfly 2.5" NPT	
690230-1	Control Valve, butterfly 3.0" NPT	
693005-1	Cable, control valve, 25 ft.	1 per carburetor
693005-2	Cable, control valve, 50 ft.	
693006-1	Cable, oxygen sensor, 25 ft.	1 per carburetor
693006-2	Cable, oxygen sensor, 50 ft.	
610621	Oxygen sensor	1 per carburetor
**	"K" Thermocouple Probe (ungrounded w/thermowell)	1 per carburetor, plus 2 for Catalyst In/Out
**	"K" Thermocouple Ext. Wire	50 ft. per thermocouple
**	12-16 AWG Hook-up Wire	150 ft. per engine

** Not supplied in Altronic kits.

2.2 FIG. 11 lists the accessory kit contents.

2.3 REFER TO FIGS. 1 OR 2 for the general layout of components used in the EPC-100E control system.

3.0 MOUNTING THE EPC-100E

3.1 The EPC-100E is preferably panel-mounted off the engine in such a manner as to minimize exposure to vibration.

REFER TO FIG. 3 for mounting details.

3.2 The EPC-100E controller should be mounted within 50 ft. of the exhaust stack of the engine which will be controlled.

3.3 Operating temperature range is -40° to 158°F. / -40° to 70°C. Humidity specification is 0-95%, non-condensing. The EPC-100E is rain and weather resistant; however the mounting site should provide as much protection from inclement weather as is practical. Avoid mounting the LCD display and keypad in direct sunlight.

NOTE: If possible, keep the original shipping container. If future transportation or storage of the controller is necessary, this container will provide the optimum protection.

4.0 MOUNTING THE OXYGEN SENSORS

4.1 The sensor should be installed in the exhaust system between the engine and the catalytic converter and/or muffler. The mounting location should be as close to the exhaust manifold of the engine as possible. The tip of the sensor should be exposed to the unobstructed flow of the exhaust gases from all cylinders to be controlled by that sensor. On a V-engine using two control banks, each sensor should be mounted such that it is exposed only to exhaust from the appropriate bank of the engine. This requires that the sensors be positioned at a point before the two banks join together. On engines using only one control bank, exhaust flow from all cylinders must be sensed. This means that the sensor should be mounted near, but still before the exhaust stack. **DO NOT** locate the sensor in a coupling or in a location where the exhaust gas flow is uneven due to obstructions or sharp bends. The sensor location chosen should allow easy access since sensor replacement may be required as often as every 2000 hours in some applications. The location chosen should not subject the exterior shell of the sensor to an ambient air temperature greater than 350°F.

NOTE: A weldment boss may be required for sensor installation in soft or thin wall exhaust systems.

4.2 Drill, tap and spot face a hole in the exhaust pipe at the selected location. A flat smooth sealing surface is required to assure accurate readings since air or exhaust leaks will impact sensor operation.

SEE FIG. 4 FOR DETAILS

4.3 New sensors are packaged with an anti-seize compound already applied to the threads. There is no need to apply additional anti-seize unless reinstalling a used sensor. If required, use high temperature anti-seize very sparingly and apply only to the sensor threads. Sensors should be torqued to 28-34 lb.-ft.

5.0 MOUNTING THE K-TYPE THERMOCOUPLES

- 5.1 EXHAUST TEMPERATURE THERMOCOUPLES** are used to monitor the temperature of exhaust gases near the exhaust oxygen sensor and should be mounted as close as possible to the appropriate O₂ sensor. As with the O₂ sensor, the location should be easily accessible, and the tip of the probe, which should be enclosed by a thermowell, should be surrounded by unobstructed exhaust flow.
- 5.3 CATALYST PROTECTION THERMOCOUPLES** should be installed in the catalyst housing. Provision for thermocouple installation is normally provided for in the design and manufacture of the catalyst. Installation of the thermocouples on the inlet to the catalyst and the outlet of the catalyst provides three modes of protection: High Inlet Temp Shutdown, High Outlet Temp Shutdown and High Catalyst Temperature Rise Shutdown. Consult catalyst manufacturer's recommendations for required overtemp protection.
- 5.3 ONLY UNGROUNDED THERMOCOUPLE PROBES** can be used with the EPC-100E. Grounded type thermocouples will not function correctly. Resistance from either lead of the thermocouple to the probe shell should be 2 megohms or greater.

NOTE: For detailed instructions covering the gas control valve, see form GCV1 OM (690154 series) or GCV2 OM (6902XX series).

6.0 MOUNTING THE FUEL CONTROL VALVES

- 6.1** In order to control the air/fuel ratio, an electronically controlled valve is connected in series between each regulator and carburetor. These valves should be installed as close to the fuel inlet of the carburetors as possible. The distance from the valve to the carburetor inlet should not exceed 12 pipe diameters in length. The valves should be installed with the control cable connector facing upward to avoid the collection of condensation in the stepper motor. Pre-drilled mounting holes are provided for user supplied brackets.
- 6.2** If possible connection piping should be of the same diameter as currently in use. The threaded connection to the valve body may require the use of thread adapters. If adapters are used, proper plumbing procedures must be followed.
- 6.3** The control valves are connected to the EPC-100E using the 693005 cables. If it is desired to enclose the cables in conduit this can be accomplished by cutting the 693005 cable in half. The cables are color coded and must be reconnected with each wire color matching. These cables must not be run in the same conduit as the ignition primary or other wires. A distance of 4 to 6 inches should be maintained between EPC-100E wiring and other engine wiring. Note that the upper connector on the EPC-100E controls the stepper valve for single control channel applications and the left bank valve on V-engines.

EPC-100E AIR-FUEL CONTROLLER

7.0 ELECTRICAL HOOK-UP

- 7.1** The power connections to the EPC-100E must be in accordance with the National Electrical Code. The EPC-100E is suitable for installation in Class I, Division 2 Group D locations.
- 7.2** Although the input power has internal protective fuses (3 amp), an external fuse (5 amp min.) near the power source is recommended.
- 7.3** The EPC-100E can be powered in one of the following ways:
- 24 volt battery with trickle charger (1 amp min. output).
 - DC power supply capable of furnishing 10-30 VDC, 2 amps.
 - Altronic 24 VDC Alternator Power Package –see form ALT.
- 7.4** Power wiring and signal (transducers) wiring must be in separate conduits and conduit entries into the EPC-100E to avoid undesired electrical interaction. Separate as follows (SEE FIG. 5):

Left Conduit Entry: Power Wiring and Earth Grounding

Center Conduit Entry: Signal Wiring; Oxygen Sensor wiring and Thermocouple inputs.

Right Conduit Entry: Alarm Outputs

- 7.5** Input power supply wires (16 AWG minimum) should enter the left most conduit entry and connect to the 24 volt supply terminals of terminal block TS2A. An earth ground wire (12 AWG minimum) should enter this same location and connect to the Earth Ground terminal. This connection is in addition to the power negative which may also be grounded.
- 7.6** Oxygen Sensors are connected via shielded cable P/N 693006. These should be run in conduit with, **AND ONLY WITH**, the EPC-100E thermocouple connections. These cables should enter the EPC-100E enclosure through the center conduit opening and connect to terminal block TS2B. The red wire should be connected to the O₂ sensor (red) terminal, and the black wire to the O₂ sensor (black) terminal. The shield wire should be cut short and not connected. Care should be taken to identify the left from right bank sensor wires. The cables provided are terminated with weather tight connectors which mate to the O₂ sensors provided by Altronic. The shield wire (green wire at connector end) must be connected to the exhaust piping near to the sensor. This shield will assist in rejecting noise from other wiring which could affect the O₂ sensor signal.

REFER TO FIGS. 4 AND 5

NOTE: Voltage and current supplied must be sufficient to operate all transducers used in the installation. If a heated Oxygen Sensor is required, the heater current must be added to the requirements shown.

NOTE: Engines using positive ground DC accessories or starter motors will require a separate dedicated ungrounded power supply for the EPC-100E.

7.7 The thermocouple (24 AWG min. type K extension) wires should be run in a conduit with and only with the EPC-100E O₂ sensor wires. These thermocouple wires should enter the enclosure through the center conduit opening and connect to terminal block TS2C and TS4. The yellow wire should be connected to the T/C (**YELLOW**) terminal and the red wire to the T/C (**RED**) terminal. Again, care should be taken to identify the four thermocouple wires (**LEFT, RIGHT, CATIN, CATOUT**).

SEE SECTION 20.0 FOR DETAILS

7.8 The **OUT 2 PSD** is configured as a normally closed output signal. Any of the protection shut down (**PSD**) diagnostic thresholds will cause this output to open. Connect this output to the safety shutdown system in combination with a relay to result in an engine shutdown for the purpose of catalyst protection. This output is not latching and self-resetting upon the clearing of related protection conditions. (SOLID STATE SWITCH RATED 30 VOLTS/0.5 AMPS MAX)

7.9 The **ALARM OUTPUT** is configured as a normally closed output signal. Any diagnostic relating to measured temperatures, O₂ sensor voltages, or rich or lean limit stepper positions will cause this output to open for identification of possible improper airfuel control system operation. This output is not latching and is self-resetting upon the clearing of all the alarm conditions. (SOLID STATE SWITCH RATED 30 VOLTS/0.5 AMPS MAX)

7.10 Although the basic application of the EPC-100E does not require a computer to be operated or installed, a serial port, located on the control board assembly, has been included which can be used for MODBUS RTU slave communications. Connections using RS-485 (3 position plug TS3) or RS-232 (DB9 connector) are supported (**SEE FIGURE 6**). The port configuration is accomplished using the display and keypad as described in **SECTION 12.18**. A software terminal package which permits communication with the EPC-100E is provided on a CD-ROM shipped with each unit. This Modbus based PC program provides operational monitoring and the capability to adjust default parameters and setpoints remotely. On screen directions and help are provided by the Altronic terminal software. Modbus communication register lists may be used to interface to PLC or SCADA systems.

SEE SECTION 20.0 FOR MODBUS REGISTER DETAILS.

*Note: this output can be restored to the closed position by pressing the **ALARM ACK** key to acknowledge the condition.*

8.0 THEORY OF OPERATION

8.1 The primary task of the EPC-100E is to accurately control the exhaust air fuel ratio (AFR) of an engine. Control should be maintained through reasonable load and fuel BTU variations.

8.2 Three-way catalysts are used to oxidize CO and HC and to reduce NOx. These processes require high temperature and correct AFR control. Catalysts perform best for all emissions when operated near the stoichiometric AFR.

8.3 The stoichiometric AFR is the AFR at which exactly the required amount of air (O₂) is present to completely burn all of the fuel. Because no engine can perform perfect combustion, typical emission by-products include O₂, HC, NO and CO even though the engine is running at stoichiometry. The stoichiometric AFR is determined by the chemical composition of the fuel, thus they are different for each fuel, or BTU rating.

(e.g. Methane => 16.09 : 1 and Gasoline => 14.70 : 1)

8.4 Because the fuel type is not always known, it is often easier to specify the AFR target in terms of Lambda. Lambda is an indicator of AFR normalized to the appropriate Stoichiometric AFR.

(Lambda Actual AFR/Stoichiometric AFR)

Thus Lambda for stoichiometric combustion would be 1.0, no matter what the fuel.

Lambda > 1 = Lean, Lambda < 1 = Rich.

8.5 An O₂ sensor (lambda sensor) is used to provide exhaust AFR feedback to the EPC-100E. This type of sensor uses a zirconia element which, when combined with a catalyzing outer surface, creates an output voltage used to indicate lambda. Characteristics of the sensor include: an output range of about 0.1 to 0.9 volts when above 650°F, a very high output impedance when cool, a very high sensitivity at stoichiometry and a very low sensitivity away from stoichiometry. The output signal provides a very suitable means of controlling just rich of Lambda 1.0 which is the AFR range required to obtain best catalyst efficiencies for methane-based fuels.

FIG. 4 describes a typical sensor output voltage curve versus lambda.

8.6 Type K thermocouples are used to assure that exhaust temperatures are high enough for correct operation of the sensor before closed loop control is enabled. Additional thermocouples are used to monitor catalyst temperatures: In, Out and Rise. Temperature limit setpoints are provided to create a catalyst protection shut-down capability.

- 8.7** An electronic valve is used to create a variable restriction between the fuel pressure regulator and the carburetor inlet. This restriction is used to adjust the effective inlet pressure seen by the carburetor and results in a mechanical adjustment of the air/fuel mixture delivered by the carburetor. A stepper motor adjusts the restriction by moving a plunger inside the valve. A stepper motor is a brushless motor consisting of a permanent magnet armature and a four-coil multi-pole stator. The armature is moved by sequentially pulsing the four stator coils. Coupled to a worm screw, the rotating armature of the motor provides very accurate linear positioning capability. The motor used provides 1700 steps of travel at .0005 inch/step for a total valve stroke of 0.85 inch.
- 8.8** The EPC-100E adjusts the stepper motor to maintain a specific input voltage from the O₂ sensor. When the sensor voltage is above the O₂ Target voltage, the system is richer than desired, and the stepper position is increased to further restrict fuel flow to the carburetor. Conversely, when the sensor voltage is below the O₂ Target voltage, the system is leaner than desired, and the stepper position is decreased to reduce the restriction of fuel flow.
- 8.9** Because the sensor voltage output is not linear with lambda, it would not be practical to adjust the system faster when the error from the set-point is greater. So in order to maximize the control response, the motors are instead adjusted faster as the error persists longer. This method provides rapid response characteristics as well as control stability. Control target voltages must be determined with the use of an exhaust analyzer to locate the operating point of lowest stack emissions. These target values are adjustable in the EPC-100E through the keypad. The resulting system provides accurate and stable control of air/fuel ratio which results in high catalyst efficiencies and reduced stack emissions.

EPC-100E AIR-FUEL CONTROLLER

9.0 PRE-START INSTALLATION CHECKLIST

9.1 BEFORE APPLYING POWER TO THE EPC-100E:

- A. Measure the power supply voltage to assure voltage is within limits (10-30 volts). Leave unit un-powered.
- B. Inside the EPC-100E, disengage terminal block TS2B and TS4 and measure resistance between the red and black O2 sensor wires. Resistance should be higher than 2 megohms if sensors are cool. This verifies that wires are not shorted in conduit.
- C. Inside the EPC-100E, disengage terminal block TS2C and TS4 and measure voltage between yellow and red thermocouple wires. The voltage should be 0.80-1.50 mV for temperatures 60-100°F. This verifies that thermocouple wires are terminated. If engine had been running, measurements will be higher, reflecting higher actual temperatures.
- D. With the terminal block still disengaged, measure resistance between the red wire and the still connected earth ground terminal. Resistance should be very high or open circuit. Repeat measurement between yellow wire and earth ground. This verifies that thermocouples are ungrounded and that wires are not shorted in conduit.

9.2 WITH THE EPC-100E POWERED UP AND THE ENGINE NOT RUNNING:

- A. Display should follow the power-up sequence **DESCRIBED IN SECT. 11.2.**
- B. Display of O2 sensor voltages should go to 0.5 volts. This may require a few minutes. **SECTION 14.0** explains how to view data screens.
- C. Data display screen for exhaust temperatures should indicate ambient temperatures.
- D. Disengage terminal block TS2B and TS4 and measure voltage between black O2 sensor wire and still connected earth ground terminal. The voltage should be 0 volts \pm 50 mV. This is to test for potential ground loop problems.
- E. Control valve operation should be verified during a start position command. This can easily be done if the valves are not yet fully installed in the fuel line. Press **ALARM ACK** if the alarm LED is on. Then press **F1** followed by **START POS.** During the start position activity, the left valve plunger should be fully retracted then positioned near the middle of its travel, followed by the right valve. No movement, erratic movement, or movement in the wrong direction will result from incorrect wiring of the stepper cables.

NOTE: If engine was running recently, temperature will be higher.

NOTE: Ground loops could be more significant when the engine is running. The addition of other electrical devices may affect EPC operation with regard to signal offsets.

F. RETURN THE SET-UP VALUES TO THE FACTORY DEFAULTS:

This can be done by slowly pressing the following keys in order **F1, F3, F2, F4**. Then, once the screen indicates that you are in the set-up mode, press **F2** followed by **F2** again to restore default setup values. Then press **F4** to exit the setup mode. The default values are set as follows:

Gain Value = 0.50

Left O₂ Target = 0.80 volts

Left Default Position = 1000 steps

Right O₂ Target = 0.80 volts

Right Default Position = 1000 steps

NOTE: Settings should be established based on catalyst manufacturer's recommendation.

G. CONFIGURE CATALYST PROTECTION THRESHOLDS:

This can be done by slowly pressing the following keys in order **F1, F3, F2, F4**, Then, **F1** to view each successive set-up parameter:

Exh Temp Hi = 1000°F

Exh Diff Hi = 200°F

Cat In Hi = 1000°F

Cat Out Hi = 1100°F

Cat Rise Hi = 100°F

- 9.3** When all of these checks have been made successfully, move on to the Start-Up Procedure.

EPC-100E AIR-FUEL CONTROLLER

10.0 START-UP PROCEDURE

10.1 BEFORE STARTING ENGINE:

- A. Check for fuel leaks where the fuel line was modified.
- B. Verify that a catalyst over-temp thermocouples and thresholds are in place and functional according to catalyst provider requirements and recommendations.
- C. Press **F1**, then press **START POS** on the EPC-100E keypad to reset stepper position and enable the warm-up delay.
- D. Be sure that the power screw adjustments on carburetors are full open or full rich. If these adjustments are not fully open, then the control range of the stepper control valve will be limited.
- E. If the alarm outputs of the EPC-100E are being used, temporarily disconnect or override these signals so that an alarm indication will not shut down the engine during setup.
- F. Verify that the catalyst protection output is wired and functional to cause a shutdown in an overtemp condition.
- G. Place EPC-100E controller in **MANUAL** mode by pressing **LEFT MANUAL**, then **RIGHT MANUAL** keys.
- H. Start and warm-up engine.

10.2 WITH THE ENGINE RUNNING:

- A. Load engine to desired operating point.
- B. Verify that the exhaust temperature data screen is displaying reasonable values, and that the temperatures exceed 650°F. **REFER TO SECTION 14.0 FOR DISPLAY KEY OPERATION**
- C. Enable automatic control by pressing the **AUTO OPER** key. The unit should begin adjusting the stepper valves trying to control the engines air/fuel ratio. Use any diagnostic warnings which may occur to trouble-shoot the system. Rich or lean limit errors are a good indication that the pressure regulators need some adjustment.
- D. Once the unit has gained control of the engine (O2 sensor voltage very near the target voltage), adjust the fuel pressure regulators until the EPC-100E is controlling with the stepper valve positions near 1000 steps. This is approximately the middle of the valve's control range.

10.3 FINETUNE THE CONTROL SETPOINTS:

- A. Using an exhaust analyzer, determine the set-point voltage which results in the best emission performance. This can be done by incrementally adjusting the O₂ Target voltage in the Set-Up Mode. Reference section 12.0 for an explanation of the setup mode. Alternatively, manual mode can be used to adjust the control valves to the positions which give the best emissions performance. **REFERENCE SECTION 15.0** for an explanation of manual mode operation. Then the O₂ Target voltages should be adjusted to match the actual sensor voltages using the **SET-UP** mode.
- B. The control gain rate and default stepper positions can also be adjusted now; however, the default values represent the best typical values for these parameters.

10.4 ONCE THE SYSTEM IS CONTROLLING AT THE BEST EMISSIONS POINT, THE ALARM OUTPUT CAN BE RE-ENABLED.

10.5 AT THIS POINT, THE EPC-100E SET-UP IS COMPLETE; THE UNIT SHOULD BE CONTROLLING THE ENGINE.

EPC-100E AIR-FUEL CONTROLLER

11.0 GENERAL: KEYPAD AND DISPLAY OPERATION

11.1 The EPC-100E includes a front-mounted keypad and an LCD display which permits the monitoring and adjustment of various parameters and actions. Two LED indicators are also included. The power LED (**GREEN**) is illuminated any time there is power to the unit. The alarm LED (**YELLOW**) will come on momentarily on power up then go out as soon as the unit is running. The alarm LED is used to indicate when a diagnostic test is violated. **REFERENCE SECTION 16.0** for more detail regarding diagnostics and the alarm indicator.

11.2 The keypad and display function together as the user interface. Only one key on the pad should be pressed at one time. Some commands require a key sequence (a series of key presses, one followed by the next). Whenever possible, special messages indicate what is happening or why a command is not accepted.

11.3 With the engine not running (cool exhaust), when power is first applied to the EPC-100E, the display will show an Altronic product description message.

```
Altronic Inc.  
EPC110E StoicAFC
```

11.4 After a few seconds the display will indicate that the controller is in warm-up mode. This display indicates that the thermocouples are still reading temperatures too cool for the O2 sensors to function correctly. The number at the end of the message indicates the current stepper valve position in steps. If the engine is not started this condition will persist for 10 minutes.

```
L AutoWarmUp1000  
R AutoWarmUp1000
```

11.5 After 10 minutes with a cool exhaust, the display will now begin rotating the diagnostic messages for low exhaust temperature. All diagnostic messages include the **!** character for recognition. Diagnostics exist for several functions and are **EXPLAINED IN DETAIL IN SECTION 16**. When any diagnostic condition is present, the status containing **!** will appear, then all of the appropriate descriptions will follow in rotation. The number in the warning message represents the present stepper valve position.

```
L!Auto!.802v1000  
R!Auto!.802v1000
```

AND

```
L! EXH TEMP LO !  
R! EXH TEMP LO !
```

11.6 Press **ALARM ACK** and the alarm LED which was turned on by the above warning will begin to flash. The low temperature alarm has now been acknowledged and the EPC-100E will accept other keypad commands. Any time the alarm LED is on steady, no keypad commands will be accepted until the **ALARM ACK** key is pressed. The display will indicate that the unit is responding to this command with message **WORKING**.

12.0 SETUP MODE: KEYPAD AND DISPLAY OPERATION

NOTE: all screens in setup mode include the \$ character.

12.1 Once the alarm LED is no longer on steadily, press **F1** followed by **F3** followed by **F2** followed by **F4**. This is the setup mode entry key sequence. The display will indicate that the setup mode is now active.

```

$$$ SETUP $$$
F1=Next F4=EXIT
    
```

12.2 Press **F2** then press **F2** again to restore factory default parameters. This special command can be used only from this screen when the user wants to restore factory default values. A message will indicate that the default values have been restored, then will return to the main setup message. **NOTE DEFAULT VALUES LISTED IN SECTION 9.2**

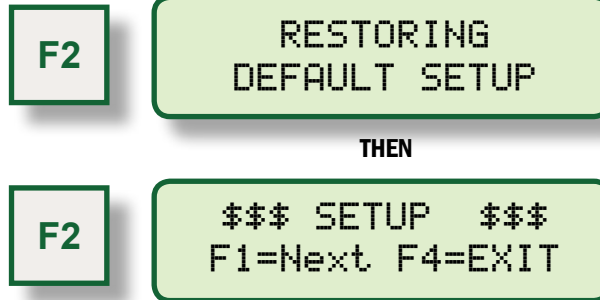

12.3 Press **F1** to increment to the control gain setup screen. The factory default value for this parameter is 0.50 as shown on the display. This parameter determines the stepper valve adjustment rate when in automatic mode. The higher the value the faster the controller will move the stepper in response to the O2 sensor.

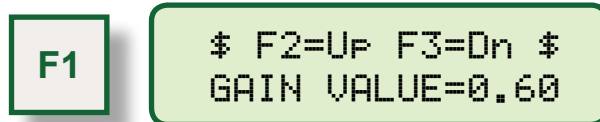

NOTE: Multiple presses of the key are required to continue incrementing the value. If the key is held, the value will be adjusted at a progressively faster rate.

12.4 Press **F2** to increase the value for the gain parameter. The display will indicate that the value has been changed. At this point the value is updated and will be used until the value is changed again.

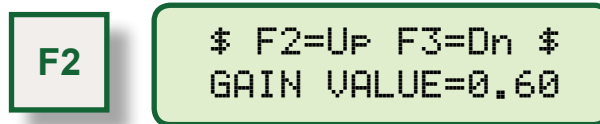

EPC-100E AIR-FUEL CONTROLLER

- 12.5** Press **F3** to decrease the value. Now the value is decreased to the default value again. The range for the gain value is limited to (0.1 to 2.0). The value cannot be moved beyond its limits.

F3

```
$ F2=Up F3=Dn $  
GAIN VALUE=0.50
```

- 12.6** Press **F1** to increment to the left O2 Target setup screen. The factory default value for this parameter is 0.80 volts as shown on the display. Like the gain value, the target can be increased and decreased with the **F2** and **F3** keys. The typical range is near 0.8 volts. The allowable range is 0.01 to 1.05; however most sensor's output range is limited to 0.1 to 0.9 volts.

F1

```
$ F2=Up F3=Dn $  
L02SetPnt=0.800v
```

- 12.7** Press **F1** to move to the right O2 Target setup screen. This screen functions just like the one described in section 12.6 for the left bank. In a single bank application, this set-up screen would be skipped.

F1

```
$ F2=Up F3=Dn $  
R02SetPnt=0.800v
```

- 12.8** Press **F1** to rotate to the left default stepper position screen. The default position is used when any of the O2 sensor or thermocouple diagnostics are active. The number on the right is the current default position. Because the temperature diagnostic is still active, the actual stepper position on the left is also 1000.

F1

```
$F2=chn9 L.dflt$  
1000 ---> 1000
```

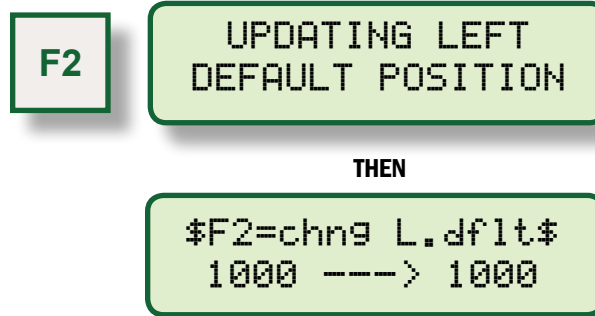

- 12.9** Press **F2** to update the default position (on right) with the value of the current position (on left). Since both values are the same no change was actually made in this example. By using the manual mode which is **DESCRIBED IN SECTION 15.0**, the actual position can be adjusted to the desired position before entering the setup mode.

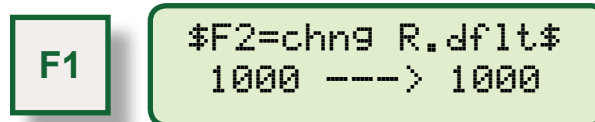

- 12.10** Press **F1** to move to the right default stepper position screen. This screen functions just like the one described in section 12.7 for the left bank. In a single bank application, this set-up screen would be skipped.

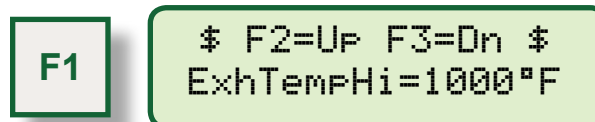

- 12.11** Press **F1** to rotate to the first temperature protection setup value. The **EXHAUST TEMPERATURE HI** setpoint represents the maximum permitted engine exhaust temperature as sensed by the left and right (dual bank) thermocouples mounted near the O₂ sensors. High temperatures at these locations may indicate engine overload or engine misfire. The **OUT 2 PSD** as well as the **ALARM** output switch will open if this threshold is exceeded to cause a protection shutdown. The same value is used to test both left and right bank temperatures.



EPC-100E AIR-FUEL CONTROLLER

- 12.12** Press **F1** to rotate to **LVS R EXHAUST TEMPERATURE DIFFERENCE HI** setting. For dual bank applications, the absolute difference between the left and right bank thermocouples will be compared to this threshold. If the temperature difference exceeds the setpoint, then the **OUT 2 PSD** as well as the **ALARM** output switch will open to cause a protection shutdown. A condition of misfire or improper bank to bank engine balance are potential conditions identified by this test.

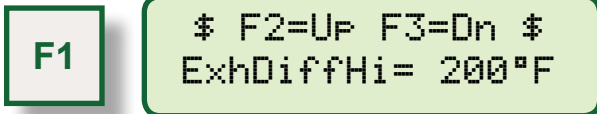

A screenshot of the controller's display. On the left, a small box contains the text 'F1'. To its right, a larger rounded rectangle contains the text: '\$ F2=Up F3=Dn \$' on the top line and 'ExhDiffHi= 200°F' on the bottom line.

- 12.13** Press **F1** to display the **CATALYST-IN HI** temperature setpoint threshold. If the inlet temperature to the Catalyst should exceed this setting, then the **OUT 2 PSD** as well as the **ALARM** output switch will open to cause a protection shutdown. Conditions of misfire or overload or improper engine operation may be identified by this test. Extreme temperature at the inlet to the catalyst will lead to premature failure of the catalyst element and its support structure. Consult the catalyst manufacturer for the recommended inlet temperature shutdown limits.

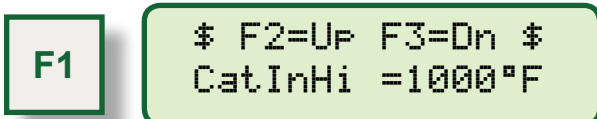

A screenshot of the controller's display. On the left, a small box contains the text 'F1'. To its right, a larger rounded rectangle contains the text: '\$ F2=Up F3=Dn \$' on the top line and 'CatInHi =1000°F' on the bottom line.

- 12.14** Press **F1** to display the **CATALYST-OUT HI** temperature setpoint threshold. If the outlet temperature of the Catalyst should exceed this setting, then the **OUT 2 PSD** as well as the **ALARM** output switch will open to cause a protection shutdown. Conditions of misfire or overload or improper engine operation may be identified by this test. Extreme temperature at the outlet of the catalyst indicates that the catalyst is being damaged by the operation conditions of the engine. Provision may be provided in the catalyst to mount a temperature probe at the catalyst element. This location may serve as an alternative to catalyst outlet temperature. Consult the catalyst manufacturer for the recommended outlet-temperature shutdown limits.

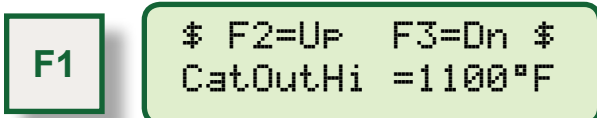

A screenshot of the controller's display. On the left, a small box contains the text 'F1'. To its right, a larger rounded rectangle contains the text: '\$ F2=Up F3=Dn \$' on the top line and 'CatOutHi =1100°F' on the bottom line.

12.15 Press **F1** to display the **CATALYST TEMPERATURE RISE HI** setpoint threshold. The temperature difference Outlet – Inlet is compared to this setpoint to identify excessive temperature rise across the catalyst. This condition of temperature rise is an indication that the catalyst is reacting unburned air and fuel that may result from a misfire or condition. If the temperature rise across the Catalyst should exceed this setting, then the **OUT 2 PSD** as well as the **ALARM** output switch will open to cause a protection shutdown. Consult the catalyst manufacturer for the recommended temperature rise shutdown limits.

F1 \$ F2=Up F3=Dn \$
CatRiseHi= 100°F

12.16 Press **F1** to display the **NUMBER OF BANKS** setting screen. The EPC-100E must be configured for dual (2) or single (1) bank operation mode.

F1 \$ F2=Up F3=Dn \$
Number Banks = 2

12.17 Press **F1** to display the **MODBUS NODE ID** setup screen. Valid node ID's are 1 to 250 permitting the communication system to incorporate multidrop communications to various ModBus slave devices.

F1 \$ F2=Up F3=Dn \$
ModBus ID=100

12.18 Press **F1** to display the **MODBUS PORT** setup screen. Various baud rates and parity modes are supported by the EPC-100E. The selections include baud rates of (300, 600, 1200, 4800, 9600, 19200, 38400, 57600). The selection of parity includes (Even, Odd and None). The selection of port types includes (RS485 and RS232, both support half-duplex ModBus RTU).

F1 \$ F2=Up F3=Dn \$
485ModBus9600n81

12.19 Press **F1** to rotate back to the main screen.

F1 \$\$\$ SETUP \$\$\$
F1=Next F4=EXIT

EPC-100E AIR-FUEL CONTROLLER

12.20 Press **F4** to exit the setup mode. **F4** can be used from any setup screen. Remember all setup screens have the **\$** character on them somewhere. This returns the display to the warning message which was caused by low exhaust temperatures.

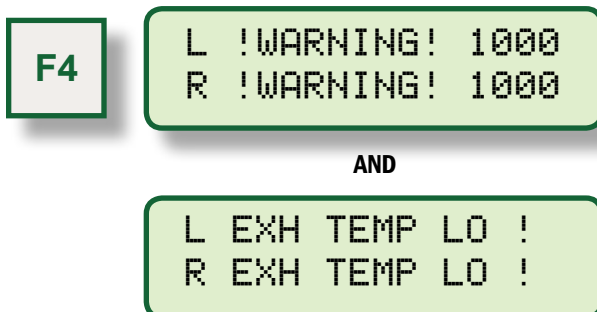

Note: Loading default settings as shown in section 12.2 does not affect settings relating to the OUT 2 PSD or ModBus configuration.

13.0 ENGINE STARTUP: KEYPAD AND DISPLAY OPERATION

13.1 Press **ALARM ACK** to acknowledge alarms if alarm LED is **ON**.

13.2 Press **F1** then press **START POS** to send the steppers to start position (stepper default position) and disable the alarm warnings for 10 minutes. The controller will return each stepper to its start position and then display the warm-up screen. This procedure should **ALWAYS** be used when starting the engine.



13.3 Now the engine should be started, warmed up and loaded. Temperature requirements would be met before the 10 minute delay expires and the controller would go into automatic control. Both the current left O₂ sensor voltage, and the current left stepper valve position are provided on the automatic display screen.

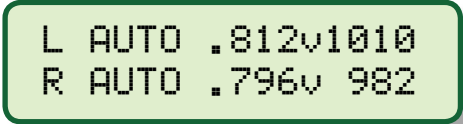

EPC-100E AIR-FUEL CONTROLLER

14.0 DATA VIEWING: KEYPAD AND DISPLAY OPERATION

14.1 Press **DSPL SEL** to display the first data view screen. The first data screen displays the current O2 sensor voltages.

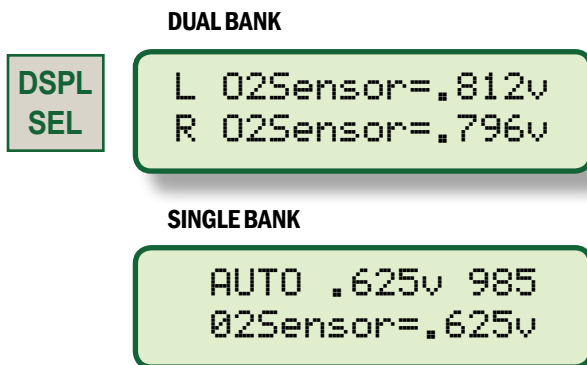

14.2 Press **DSPL SEL** again to display current O2 target voltages.

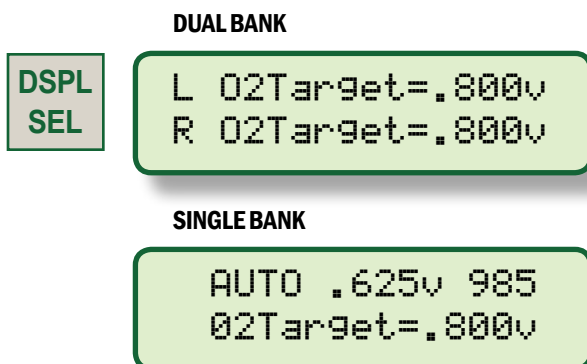

14.3 Press **DSPL SEL** again to display the exhaust temperature readings from the thermocouples near the O2 sensors.

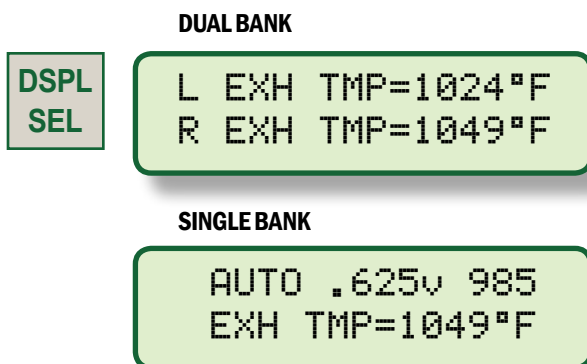

14.4 Press **DSPL SEL** again to display the Catalyst temperatures.

DUAL OR SINGLE BANK

DSPL
SEL

Cat Rise=+ 24°F
In=1098 Out=1125

14.5 Press **DSPL SEL** to view the enabled feature data.

DSPL
SEL

AUX1=1.52v= 1271
AUX2=2.22v= 2156

DSPL
SEL

AUX3=2.76v= 1271
AUX4=2.76v= 2156

DSPL
SEL

Tb1A= 382=+.030
Tb1B= 1571=+.040

DSPL
SEL

Tb1C= 1517= 1.5
Tb1D= 1517=-1517

14.6 Press **DSPL SEL** again to loop back to the automatic screen.

DUAL BANK

DSPL
SEL

L AUTO .811v1010
R AUTO .796v 982

SINGLE BANK

DSPL
SEL

AUTO .811v1010

EPC-100E AIR-FUEL CONTROLLER

15.0 MANUAL MODE: KEYPAD AND DISPLAY OPERATION

15.1 Press **LEFT MAN** to enter the manual mode for the left bank. The display will indicate **WORKING** and then return with the left bank in manual mode. This mode can be used to help setup the controller, and to diagnose problems. Because no diagnostic alarms are present, it was not necessary to acknowledge alarms. Also, once in manual mode, diagnostic alarms for that bank are disabled. The alarm LED will flash while in manual mode to serve as a reminder that the EPC-100E is not in automatic control.

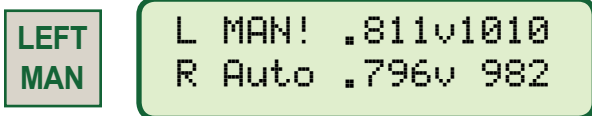

15.2 Press **RIGHT MAN** to enter the right bank manual mode.

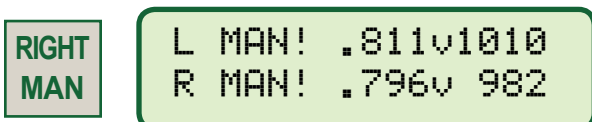

NOTE: Both the **ALARM LED** and the **ALARM output** return to the normal condition when the system fault is corrected.

15.3 Press **LEFT LEAN** to increase the stepper position by 25 steps. A descriptive message will be displayed and then the modified position will be returned. Increasing the position causes the valve to close and the mixture to change in the lean direction.

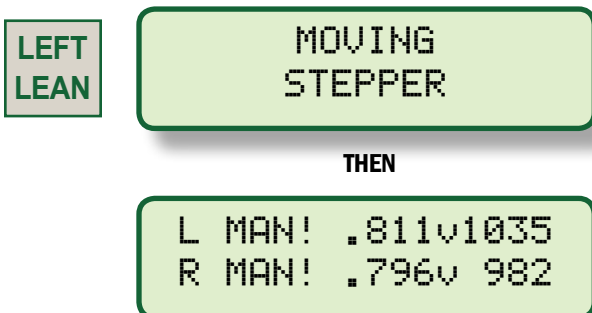

15.4 Press **LEFT FAST**, then press **LEFT LEAN** to increase the stepper position by 100 steps.

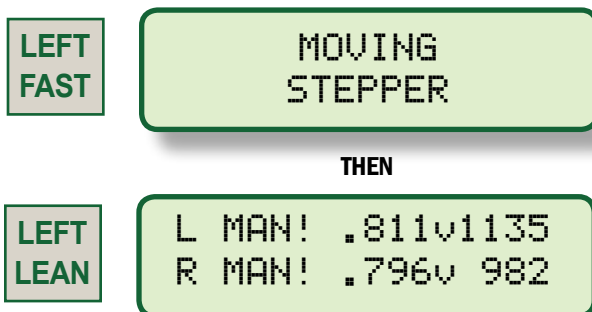

NOTE: When **F1** then **START** are pressed before starting the engine, the exhaust temperature diagnostic will be delayed 10 minutes displaying the warm-up screen.

- 15.5** Press **LEFT RICH** to decrease the stepper position by 25 steps. Decreasing the position causes the valve to open and the mixture to change in the rich direction. These same commands are used to operate the right bank using the **RIGHT LEAN**, **RIGHT RICH** and **RIGHT FAST** keys.

LEFT RICH MOVING STEPPER

THEN

LEFT MAN L MAN! .811v1110
R MAN! .796v 982

- 15.6** Press **AUTO OPER** to return to automatic mode. Any time this key is pressed, automatic mode will be enabled for both banks.

AUTO OPER L AUTO .811v1110
R AUTO .796v 982

EPC-100E AIR-FUEL CONTROLLER

16.0 DIAGNOSTIC DISPLAYS AND OPERATION

16.1 ALARM LED AND ALARM OUTPUT

The **ALARM** LED and **ALARM** output operate in conjunction with the diagnostic features of the EPC-100E. The three operation modes of these alarm features are described below:

A. Alarm LED OFF

Indicates that the unit is operating correctly in automatic mode, or in warm-up mode waiting for the exhaust temperatures to increase.

B. Alarm LED ON Steady

Indicates that the unit is attempting automatic control; however one of the diagnostic criteria has not been satisfied. The alarm indicator will stay on solid until the alarm acknowledge key is pressed at which time the LED will flash. A solid on yellow LED also indicates that the alarm output terminal is in its alarm state.

C. Alarm LED Flashing

Indicates one of two things; either an acknowledged alarm condition still exists, or the unit is in manual operation mode. The flashing LED should simply signify to the operator that the unit is not in normal automatic control. The alarm output terminal is in its normal state if the LED is flashing.

16.2 ALARM OUTPUT

The **ALARM** output is configured as a **NORMALLY CLOSED** output signal. Any system fault will open the alarm circuit including loss of power, diagnostic warnings, etc. As described above, the alarm output would be in its fault condition (open) any time that the alarm indicator on the front panel is **ON** solid.

16.3 SYSTEM DIAGNOSTICS

The system diagnostics included in the EPC-100E are designed to identify conditions which are not considered normal operation. These diagnostic tests are performed continuously while the controller is in automatic mode. Each of the diagnostics will display a descriptive message, turn on the **ALARM LED (YELLOW)** and place the alarm output in the fault condition (**OPEN**).

16.4 DIAGNOSTIC WARNING MESSAGES

Active diagnostic warning messages include the **!** character and are displayed in rotation, each message being displayed for about 1 second. The home screen uses the **!** character to indicate the status and that other diagnostics will follow in rotation.

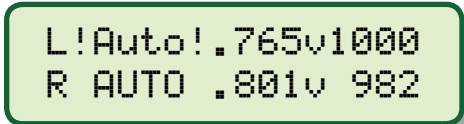

16.5 EXHAUST TEMPERATURE

The Exhaust Temperature diagnostic monitors the exhaust temperatures near the O₂ sensors as measured with the thermocouples. If the temperature is below 650°F or above 1400°F, then the EPC-100E displays the appropriate low or high message and activates the **ALARM** LED and **ALARM** output. Automatic control is also disabled and the stepper valves are positioned at the default stepper position. Thermocouple probe or thermocouple connection failures will also activate this diagnostic.



```
L EXH TEMP LO !  
R Auto .800v 982
```

OR



```
L EXH TEMP HI !  
R Auto .800v 982
```

16.6 SENSOR NOT READY

The Sensor Not Ready diagnostic is designed to identify problems with the O₂ sensor. The controller has a very high impedance pull up resistor to 0.5 volts in parallel with each exhaust sensor input. When the sensor is too cool or disconnected this will force the input to read 0.5 volts. If the controller sees that the sensor output is 0.5 volts for 10 or more seconds the EPC-100E will display the sensor not ready message and activate the **ALARM** LED and **ALARM** output. Automatic control is also disabled and the stepper valves are moved to the default stepper position. The sensor ready test is only performed if the exhaust temperature requirements of 16.5 are satisfied. Failure of this test indicates a cold, disconnected or failed sensor.

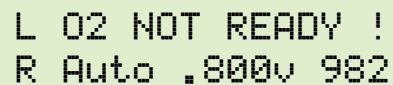

```
L O2 NOT READY !  
R Auto .800v 982
```

EPC-100E AIR-FUEL CONTROLLER

16.7 SENSOR INPUT VOLTAGE

The Sensor Input Voltage diagnostic is also designed to identify problems with the O₂ sensor. Normal input voltages should be between 0.1 and 0.9 volts. If the sensor input voltage is less than 0.1 volts or more than 1.1 volts, the EPC-100E will display the appropriate low or high message and activate the **ALARM** LED and **ALARM** output. Automatic control is also disabled, and the stepper valves are moved to the default stepper position. Failure of this diagnostic test indicates shorted wiring or a failed sensor.

```
L O2 SIGNAL LO!  
R Auto .800v 982
```

OR

```
L O2 SIGNAL HI!  
R Auto .800v 982
```

16.8 LEAN AND RICH LIMIT

The Lean and Rich Limit diagnostic monitors the stepper positions. If the position of a stepper valve is at the minimum (0) or maximum (1700) travel limit, the EPC-100E displays the appropriate message and activates the **ALARM** LED and **ALARM** output. The rich limit warning indicates that the engine is too lean and the controller cannot open the valve any further to enrich the mixture. The lean limit warning indicates that the engine is too rich and the controller cannot close the valve any further.

```
L RICH LIMIT !  
R Auto .800v 982
```

OR

```
L LEAN LIMIT !  
R Auto .800v 982
```

16.9 ENGINE OUT EXHAUST OVER-TEMPERATURE

When the left or right bank exhaust temperature exceeds the setup threshold, the alarm output will open, the alarm LED will turn on, the **OUT 2 PSD** will open, and the messages below may be displayed.

DUAL BANK

```
!L ExhTempHiPSD!  
R AUTO!WARN! 875
```

OR

```
L AUTO!WARN! 905  
!R ExhTempHiPSD!
```

SINGLE BANK

```
AUTO!WARN! 905  
!L ExhTempHiPSD!
```

16.10 ENGINE OUT EXHAUST DIFFERENTIAL

On a dual bank application, when the engine exhaust temperature differential between the banks exceeds the setup threshold, the alarm output will open, the alarm LED will turn on, the **OUT 2 PSD** will open and the message below is displayed.

```
!LvsR Delta PSD!  
!LvsR Delta PSD!
```

16.11 CATALYST INLET OVERTEMP OVER-TEMPERATURE

When the inlet temperature of the catalyst exceeds the setup threshold, the alarm output will open, the alarm LED will turn on, the **OUT 2 PSD** will open and the message below is displayed.

```
L AUTO!WARN! 905  
!CatInTempHiPSD!
```

EPC-100E AIR-FUEL CONTROLLER

16.12 CATALYST OUTLET OVER-TEMPERATURE

When the outlet temperature of the catalyst exceeds the setup threshold, the alarm output will open, the alarm LED will turn on, the **OUT 2 PSD** will open and the message below is displayed.

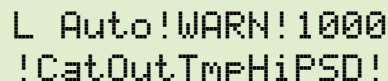

```
L Auto!WARN!1000  
!CatOutTmPHiPSD!
```

16.13 CATALYST TEMPERATURE RISE

When the temperature from the inlet to the outlet of the catalyst exceeds the setup threshold, the alarm output will open, the alarm LED will turn on, the **OUT 2 PSD** will open and the message below is displayed.

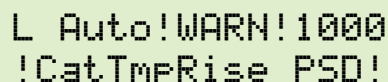

```
L Auto!WARN!1000  
!CatTmPRise PSD!
```

16.13 ADDITIONAL FEATURE ALARM MESSAGES

Additional Alarm Messages may be reported which relate to advance feature alarm setpoints.

```
L!INHIBITACTIVE!  
R!INHIBITACTIVE!  
!CATTMPDROP PSD!  
!FLEXHIORLO PSD!  
!LVSR DELTA CSD!  
!CATINTEMPHICSD!  
!CATOUTTMPLOCSD!  
!CATOUTTMPHICSD!  
!CATOUTTMPLOCSD!  
!CATTMPRISE CSD!  
!CATTMPDROP CSD!  
!FLEXHIORLO CSD!  
!L EXH02V HICSD!  
!L EXH02V LOCSD!  
!R EXH02V HICSD!  
!R EXH02V LOCSD!  
!CATINO2V HICSD!  
!CATINO2V LOCSD!  
!CATOUTO2VHICSD!  
!CATOUTO2VLOCSD!
```

17.0 AUTOLOG FEATURE

17.1 Press “F3” to display the first out Autolog screen which provides the first most recent detected cause for leaving normal automatic operation. The cause is logged to a modbus register and also presented as below on the screen using a text string. The example below indicates that a difference in the left to right bank temperatures exceeded the setpoint which resulted in a catalyst protection alarm which triggered the snapshot of auto log values. The auto log values are updated on every transition out of fully automatic control without alarms. The table of auto log causes is shown below.



```
AutoLOG Code 67
!LvsR Delta PSD!
```

**L! EXH TEMP LO !
R! EXH TEMP LO !
L! EXH TEMP HI !
R! EXH TEMP HI !
L! O2 SIGNAL LO!
R! O2 SIGNAL LO!
L! O2 SIGNAL HI!
R! O2 SIGNAL HI!
L! O2 NOT READY!
R! O2 NOT READY!
L! LEAN LIMIT !
R! LEAN LIMIT !
L! RICH LIMIT !
R! RICH LIMIT !
!L EXHTEMPHIPSD!
!R EXHTEMPHIPSD!
!LVSDELTA PSD!
!CATINTEMPHIPSD!
!CATOUTTMPHIPSD!
!CATTMPRISE PSD!
!L USER MANUAL !
!R USER MANUAL !**

EPC-100E AIR-FUEL CONTROLLER

17.2 Additional AutoLog Codes may be reported which relate to advanced feature alarm setpoints.

**L!INHIBITACTIVE!
R!INHIBITACTIVE!
!CATTMPDROP PSD!
!FLEXHIORLO PSD!
!LVS DELTA CSD!
!CATINTEMPHICSD!
!CATOUTTMPLOCSD!
!CATOUTTMPHICSD!
!CATOUTTMPLOCSD!
!CATTMPRISE CSD!
!CATTMPDROP CSD!
!FLEXHIORLO CSD!
!L EXH02V HICSD!
!L EXH02V LOCSD!
!R EXH02V HICSD!
!R EXH02V LOCSD!
!CATINO2V HICSD!
!CATINO2V LOCSD!
!CATOUTO2VHICSD!
!CATOUTO2VLOCSD!**

17.3 The following screens are viewed in rotation, displaying the next screen on each press of **F3**.

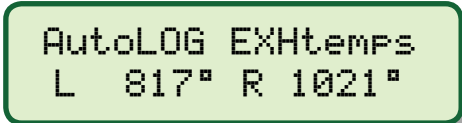

AutoLOG EXHtemps
L 817° R 1021°

Identifies the left and right bank temperatures at auto log event.



AutoLOG CATtemps
In 985° Out1057°

Identifies catalyst temperatures at auto log event trigger

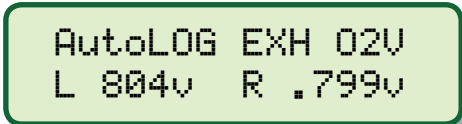

AutoLOG EXH 02V
L 804v R .799v

Identifies O2 voltage measurements at auto log event trigger

```
AutoLOG CAT 02V  
In.382v Out.378v
```

```
AutoLOG Aux 0-5v  
1=1.52v 2=2.22v
```

```
AutoLOG Aux 0-5v  
3=2.76v 4=1.75v
```

Included when features are enabled

```
AutoLOG Steppers  
L 1191 R 990
```

Identifies stepper positions at auto log event trigger

```
AutoLOG Supply V  
5.04vdd 2402v
```

Identifies internal and supply voltage at auto log event trigger

EPC-100E AIR-FUEL CONTROLLER

18.0 ADDITIONAL DISPLAY SCREENS

18.1 Three additional screens exist which can be helpful in obtaining information about the version and supply voltage and temperature of the EPC-100E. They can be viewed as follows.

Press **F1** then **DISP-SEL**, to view the version number of EPC-100E firmware.

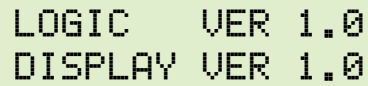

```
LOGIC   VER 1.0  
DISPLAY VER 1.0
```

Press **F2** then **DISP-SEL**, to view the version date of EPC-100E firmware.

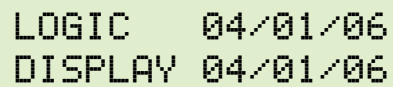

```
LOGIC   04/01/06  
DISPLAY 04/01/06
```

Press **F1** then **F2** then **DISP-SEL** to view the supply voltage and temperature.

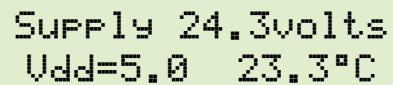

```
SUPPLY 24.3volts  
Vdd=5.0  23.3°C
```

19.0 TROUBLE-SHOOTING THE EPC-100E SYSTEM

19.1 GREEN LED AND LCD DISPLAY ARE BLANK; POWER IS INTERRUPTED.

- A. Check power supply voltage at EPC terminal block TS2A (18-30 volts), while still connected.
- B. Power down unit, then remove and check resistance of on-board fuses (**F1**) (< 2 ohms).

SEE FIG. 9

- C. Verify tight cable connections between control and display boards.

19.2 DISPLAY READS (EPC Bottom Board **!NOT Running!**); CONTROL BOARD IS NOT RUNNING.

- A. Power-down unit for 1 minute. Re-power, check display and status of **LED1C** on logic board.

- B. **LED LIT AND NOT BLINKING INDICATES:**
 - Firmware mismatch of versions
 - OR**
 - Cable between logic and display loose or broken
 - OR**
 - Display board damaged
 - OR**
 - Logic board damaged

- C. **BLINKING LED INDICATES:**
 - Logic board not running properly.
 - Verify IC in blue socket installed properly.
 - Replace logic board assembly.

- D. **LED NOT LIT INDICATES:**
 - Replace logic board assembly

SEE FIG. 9

19.3 DISPLAY TOP ROW IS DARK, BOTTOM ROW IS LIGHT; DISPLAY BOARD IS NOT RUNNING.

- A. Power-down unit for 1 minute. Then re-power and check display.
- B. On back of display board, examine both blue socketed IC's for tight engagement.
- C. Check cable connection between control and display boards.
- D. Replace display board assembly. **SEE FIG. 9**

19.4 DISPLAY IS BLANK, BUT GREEN LED IS ON. CONTRAST ADJUSTMENT REQUIRED.

- A. On back of display board adjust contrast potentiometer.
Clockwise = Lighter; Counterclockwise = Darker.

SEE FIG. 9/10 FOR LOCATION.

- B. Replace display board assembly. **SEE FIG. 9**

EPC-100E AIR-FUEL CONTROLLER

19.5 KEY PAD ENTRIES CAUSE NO DISPLAY RESPONSE.

- A. At bottom of display board, verify connection of keypad ribbon connector.
- B. Replace enclosure and keypad assembly. **SEE FIG. 9**

19.6 ALARM LED IS ON SOLID.

- A. Read the warning message on the display, and reference the diagnostic section for an explanation of the warning.
- B. Press **ALARM ACK** to permit normal keypad operation and to disable the alarm output terminal.

19.7 EPC-100E WILL NOT MOVE STEPPER VALVES DURING **F1** THEN **START POS.** COMMAND.

- A. Check stepper cable connections at EPC-100E and at stepper valve.
- B. Inside EPC-100E verify that red LED on control board is **ON**. If LED is off, or flashing check the fuses on the control board.
- C. Examine blue socketed I.C. for tight engagement.
- D. Test EPC-100E with a spare stepper valve assembly.
- E. Test EPC-100E and stepper valve assembly, with a spare stepper cable.
- F. Replace entire control board assembly. **SEE FIG. 9**

19.8 HIGH OR LOW EXHAUST TEMP WARNINGS PERSIST.

- A. Observe thermocouple readings for reasonable values using display select screens in **SECTION 14**.
- B. Compare observed readings to, and verify feasibility of catalyst protection setpoints as described in **SECTION 9.2 (G)**.
- C. If engine is not running, start and warm up engine.
- D. Test the disconnected thermocouple reading at EPC-100E with an alternate thermocouple reading device.
- E. Replace thermocouple or correct wiring if temperatures are incorrect. The life of thermocouple probes is highly dependent on the use of a thermowell and on corrosives in exhaust.
- F. If low temperature is a problem during first installation, an alternate sensor and probe location may be required. Please contact the factory before pursuing any other action to raise sensor temps.
- G. Replace entire control board assembly. **SEE FIG. 9**

19.9 RICH OR LEAN LIMIT WARNINGS PERSIST.

- A. A misfiring engine can cause the system to shift in the rich direction. Check the engine for misfiring cylinders using a timing light or exhaust pyrometer.
- B. Use an exhaust analyzer and the EPC-100E manual mode to adjust the %O₂ before the converter to around 1.0%. If the %O₂ cannot be manipulated in the manual mode, then test to make sure the stepper valve is functioning as was done during installation.
- C. If manual mode moves the %O₂ but cannot attain 1.0%, then the fuel system may need to be readjusted. First verify that the load screw adjustments on the carburetors are full rich or full open. If they are not full open, the control range of the stepper valves will be limited. Second, adjust the fuel pressure regulators so that when in automatic mode, the stepper valves are controlling near 1000 steps.
- D. If the fuel system appears to be adjusting correctly, use an exhaust analyzer and the EPC-100E manual mode to sweep the %O₂ from around 3% down to 0.2% while watching the O₂ sensor voltage on the display. The voltage should move from around 0.2 volts toward 0.8 volts as the %O₂ is changed. If this is not the case, a new sensor should be tested.
- E. If EPC-100E O₂ sensor voltage display does not match actual sensor voltage, test for ground loop problems.
DESCRIBED IN SECTION 9.2D.
- F. Replace entire control board assembly. **SEE FIG. 9**

19.10 SETUP VALUES ARE LOST AT POWER-DOWN; BATTERY FOR BBRAM IS FAILED.

- A. Replace entire control board assembly. **SEE FIG. 9**

20.0 EPC-100E ADVANCED CONTROL OPTIONS

20.1 In addition to the basic closed loop Lambda sensor control, it may be useful to apply additional automatic air/fuel ratio control trimming strategies. This might be done in an effort to secure more consistent exhaust emission levels across a wider range of operating conditions. The EPC-100E offers a number of advanced, user-customizable control options. For example, a dynamic adjustment of the pre-catalyst O₂ target setpoint based upon another measured engine operating parameter can be made. Some of the parameters which could be used to do this are post catalyst O₂, engine load, or differential temperature across the catalyst. It is also possible to automatically adjust controller gain at various load levels or other measured operating conditions to maintain the best possible control stability. Under certain other conditions a means of inhibiting automatic control on the basis of satisfying an external parameter such as load or temperature can be implemented. Selection of options is accomplished via proprietary, high-level Windows™-based Modbus RTU Terminal Program included with each Altronic EPC-100E. Operation and configuration is essentially hidden from the casual user and therefore completely resistant to tampering or unauthorized adjustment.

20.2 The user can configure the EPC-100E system to automatically adjust the target O₂ setpoint or the controller gain (responsiveness) versus a variety of measured engine operating parameters. It is also possible to inhibit automatic control based upon a specified measured operating parameter, if necessary.

20.3 Optional control inputs and outputs include:

- **Two (2) Additional Type K Thermocouple Sensors**
- **Two (2) Additional Oxygen (Lambda) Sensors**
- **Four (4) Additional General Purpose 0-5 Volt Parametric Transducer Inputs**
- **Four (4) Additional Discrete Outputs**

These inputs and outputs, combined with the Terminal Program, offer the flexibility to meet specific control requirements for exhaust gas emissions levels. Specific control strategies that can be implemented by the user are almost limitless, with various control functions used simultaneously or in combination. Examples include:

- **Dynamic adjustment of the O₂ setpoint(s) versus** post-catalyst O₂, load, catalyst differential temperature, fuel BTU, post-catalyst NO_x, ambient temperature, engine RPM, fuel flow, or other parameters.
- **Adjustment of the controller gain (responsiveness) versus** post-catalyst O₂, load, catalyst differential temperature, fuel BTU, post-catalyst NO_x, ambient temperature, engine RPM, fuel flow, or other parameters.
- **Inhibiting automatic control based on** post-catalyst O₂, load, catalyst differential temperature, fuel BTU, post-catalyst NO_x, ambient temperature, engine RPM, or other parameters.
- **Shutting down the engine or alarming based on** post-catalyst O₂, fuel flow, catalyst temperature, NO_x emissions, catalyst differential temperature, catalyst differential pressure, or other parameters.

21.0 SETTING UP THE TERMINAL PROGRAM CONNECTION

21.1 See **FIG.1** for the proper wiring to connect the EPC-100E system to a Personal Computer. Install the Terminal Program Version 5.0 which is provided on the CD-ROM shipped with the unit. The computer must have an operating system of Windows™ 95 or above. The program will auto-install to the default directory. After installing the program, the communications link to the EPC-100E must be setup. Click on the word **CONNECTION** on the top toolbar to open the connection dialog box shown below. Select an available comm. port on your computer and configure the Modbus port settings. The default communication settings for the RS-485 EPC-100E are **9600, N, 8, 1**.

REFER TO SECTIONS 12.17 AND 12.18

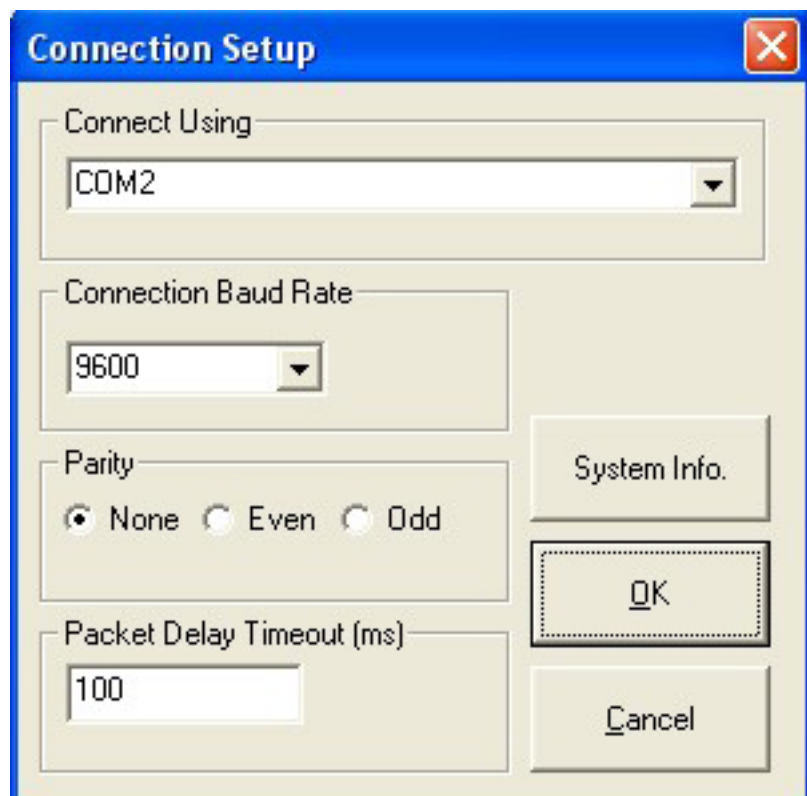

EPC-100E AIR-FUEL CONTROLLER

22.0 IMPLEMENTING THE ADVANCED CONTROL OPTIONS

22.1 With version 6.0 or later of the Terminal Program installed on a PC connected to the EPC-100E unit, the user is brought to the main or legacy screen which shows the current operating conditions.

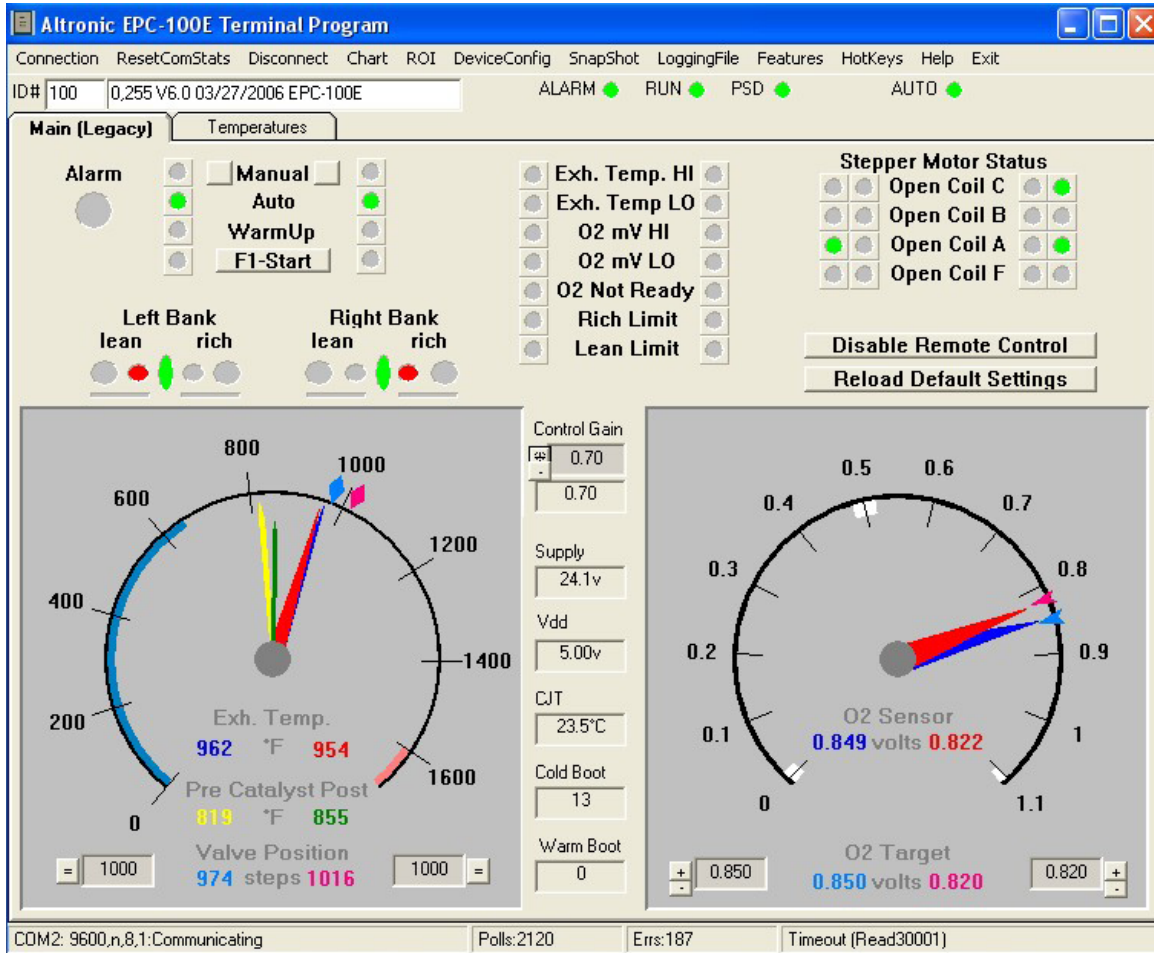

The current dynamic operating conditions are displayed on cockpit style gauges and the numeric values of temperature, stepper position and oxygen sensor voltage are shown in the bottom center of the gauge face. The numeric value of each of the parameters is color matched to the appropriate gauge needle. For example, the **RIGHT EXHAUST TEMPERATURE** is the **RED 953** on the left hand gauge display shown above. On the right hand gauge display the **BLUE 0.850** is the **LEFT BANK O2 SENSOR VOLTAGE** which matches the setpoint voltage of **0.850** shown on the outside of the gauge scale by a **LIGHT BLUE ARROW** point.

In addition to these operating values, the status of the standard EPC-100E alarms for exhaust temperature, O2 sensor voltage, rich or lean limit, and so on are also displayed. The status flag for each of these turns **RED**, whenever that particular alarm is activated. On status flags which are user selected or which are normally changing during operation a **GREEN** status flag is used to show that a particular condition is active and in the normal range of operation.

Throughout the EPC-100E terminal program **Windows Tool Tips** have been provided to help guide the user. By placing the mouse indicator over a particular item any hidden tool tips will be revealed. Typical tips would include the Modbus register address attached to a flag and its description. On user-adjustable values a suggested range would also be included.

22.2 From the legacy screen, the user can enable tabbed, individually accessible custom configuration screens via the **Features** menu. It is via these setup screens that all optional features are configured and implemented.

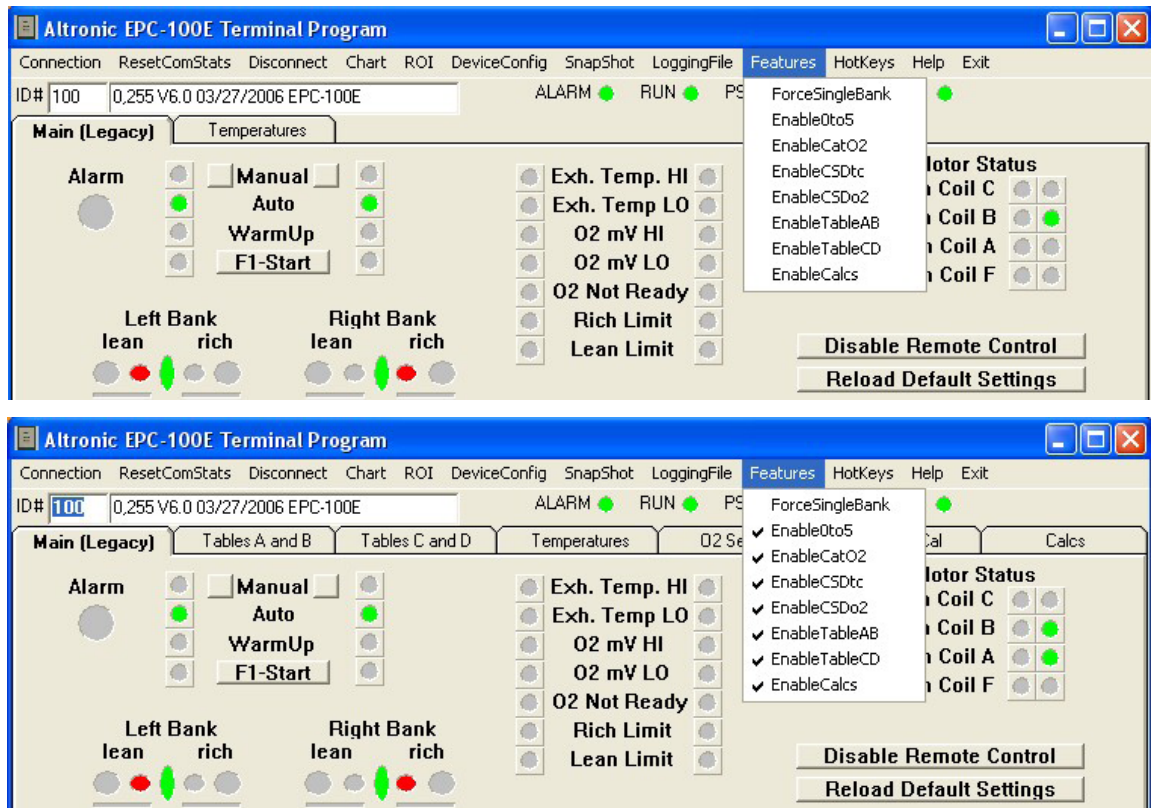

22.3 The Terminal Program on the PC is the Graphical User Interface (GUI) of the system and uses the Modbus RTU address structure to simplify the process of configuration. In general, the user creates custom control functions by entering the Modbus register number (address) assigned to a particular engine parameter into a pre-configured control function block. First, the selection of a specific input parameter to be used as control variable (engine manifold pressure, exhaust temperature, post-catalyst O₂, or other) is made, then the controller can be configured to bias the O₂ setpoint, to make a gain adjustment, enable or inhibit automatic controls, or even to incorporate additional alarm or shutdown protection. Additionally, multiple means of control versus various monitored parameters can be used simultaneously or under different operating or ambient conditions. Specific examples of the advanced capability of this control system will follow, but these are examples only. The specific relationships and values required for best emissions performance must be developed for each application.

EPC-100E AIR-FUEL CONTROLLER

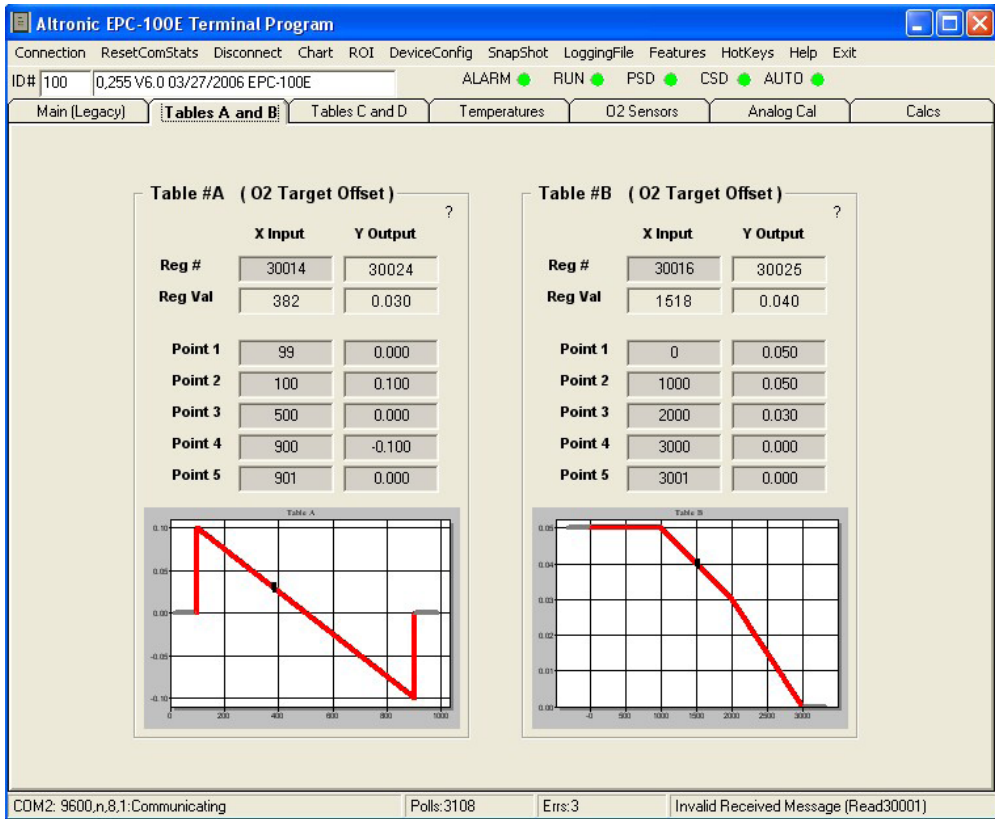

22.4 Offsetting the pre-catalyst Lambda sensor setpoint being used by the controller for closed loop control can be done with the PC program. This is the control approach used most often when a post catalyst O2 sensor or an engine load sensor is added for feedback. From the PC program click on the **TABLES A and B** tab. The screen shown above appears.

Tables A and B enable the user to establish two separate, five-point schedules by which the O2 target level would be offset relative to the input of another parameter. The Modbus address (register number) of the input parameter which has been selected as the independent variable (X value) is entered first (30014 in this example). The resultant offset value (Y value) will be stored in the Modbus register 30024. The “Y value” will be added to the fixed O2 setpoint of the pre-catalyst O2 sensors. The “Y value” (offset voltage) can be negative or positive in sign. On dual channel applications the same value will be added to both channels. Endpoint and breakpoint values are entered into the table form by clicking on the dark gray boxes. Once the cursor is inside the box, use the keypad to type in the desired numeric value. As values are entered into the table they appear in **RED**. When the values are accepted by pressing the **ENTER** key on the computer, they turn **BLACK** and the resultant graph of the programmed function will appear below the table. The X values must be entered in ascending order. Tables A and B can be used individually or cumulatively, whereby the bias (offset) generated by each of the tables would be summed to determine the offset value. Remember to use the **Tool Tips** by placing the cursor on the item of interest. There is also additional help available by clicking the **?**.

EXAMPLE 1: The following explanation refers to Table A (PAGE 42). Using an exhaust gas analyzer, the user has determined that he can minimize engine emissions by incorporating an automatic adjustment of the normally fixed pre-catalyst O₂ setpoint as a function of the signal from a post-catalyst O₂ sensor. From the Modbus register address list included with these instructions (SECTION 00.0), the register which contains the post catalyst sensor voltage is 30014, this number is entered for the X input REG#. The user has determined that the optimum catalyst performance on a given engine occurs when the post catalyst O₂ sensor is reading about 500 mV. On initial setup of the engine, the best emissions were found to occur with the pre-catalyst sensor setpoint at 720 mV, this also corresponded to a post-catalyst sensor voltage of 500 mV. In order to maintain this operating relationship over time, the post-catalyst O₂ sensor will be allowed to influence the pre-catalyst sensor setpoint by a maximum of ± 100 mV. If the post-catalyst sensor voltage is outside its normal operating range of 100 to 900 mV, it has no effect. The current values of the X and Y variables are shown directly below the Modbus register address number. The actual offset value coming from the programmed function is also displayed as the small black bar on the graph.

Note: In this example, the best relationship was not linear, so that a breakpoint at X equals 2000 when Y equals 30 millivolts was used.

Note: The permanently-configured engineering unit values for each of the pre-defined Modbus registers is included in the Modbus register listing. The Aux. analog inputs have separate Modbus register locations for the measured voltage and for user-defined engineering units. Either of these register locations may be used to add an offset, but the data needs to be entered accordingly. It is recommended that the actual input voltage being measured be used whenever possible in order to simplify basic troubleshooting.

EXAMPLE 2: In reference to Table B (PAGE 42), using an exhaust gas analyzer, the user has determined that he can minimize engine emissions by incorporating an automatic adjustment of the target O₂ setpoint as a function of engine load. Using a transducer monitoring engine intake manifold pressure (as a representation of engine load), the user has determined that the optimum O₂ sensor setpoint should range between 750mV and 700mV from zero to fullload. Thus, the baseline O₂ sensor setpoint could be established at 700mV with an offset adjustment of +50mV being made for light engine load conditions.

This example would be implemented by adding a 0-50 psi transducer (Altronic P/N 691-204-50) to the engine intake manifold and wiring it to Aux. analog input 1. The user would then enter the Modbus RTU value for that transducer (in this case, 30016 for AUX 1 0-5 RATIO-METRIC 1mv/cnt) into Table B under Reg# for the X input. This configures the system to accept the input of that transducer as the biasing input for the O₂ target value offset. To provide the EPC-100E with the schedule for when and by what value to offset the target value, the user enters the X value in transducer mV (0 to 5000mV for 0 to 5 volts) and the offset voltage in O₂ sensor mV (in this case, 0 to 50 mV).

These examples are intended only to illustrate the optional capabilities of the EPC-100E. Among the concepts with the potential to improve long-term emissions may also be using the relative activity of the on-engine catalyst as indicated by the current temperature rise across the converter, or the use of a wide band oxygen or Nox sensor post-catalyst. Likewise the use of the engine intake manifold pressure is an example of a means to sense the current engine load and offset the O₂ setpoint, but this could also be done using a KW sensor, a throttle position sensor or fuel flow signal.

In as much as the generated offset values for Tables A and B are additive, utilizing both tables simultaneously allows the user to allow for the complex interaction of operating parameters.

EPC-100E AIR-FUEL CONTROLLER

22.5 Selecting the **TABLES C and D** tab displays the following PC screen.

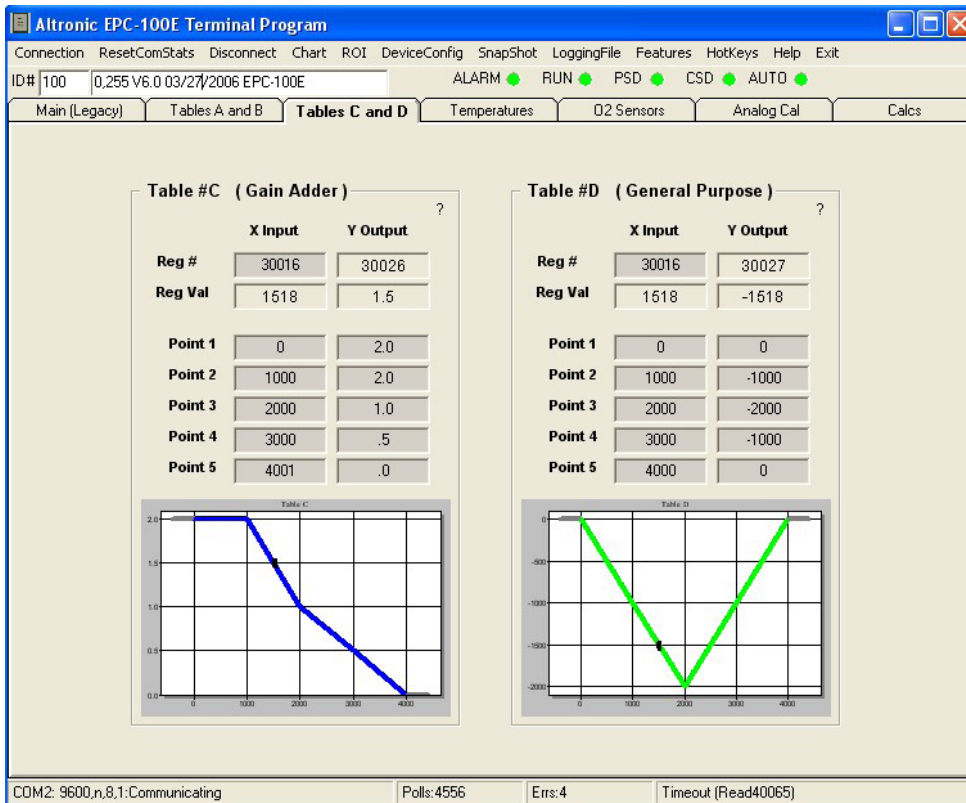

Table C can be programmed to dynamically alter the gain setting (degree of response) of the EPC-100E controller based upon the value of a Modbus register. The selected Modbus register address number is entered into the X Input Reg# box at the top of the table. The contents of the selected register can represent a measured engine parameter or could be provided serially by an external source.

EXAMPLE 1 (illustrated above): The basic fixed gain adjustment of the EPC-100E should always be optimized for the typical operating conditions of the engine. When the engine is operated at “off design” conditions, the normal gain setting may not be responsive enough to minimize variations in the emissions. In this example, the register address selected for the X Input (30016) is for the analog value connected to Aux.1. A pressure sensor measuring intake manifold pressure senses engine load. The values entered into the table result in a higher gain at lighter loads, which is often desirable because as fuel flow drops at lighter loads, the “leverage” of the flow control valve over the flow is reduced requiring a greater response to maintain control.

Table D is a general purpose function block used to translate the relationship of any one parameter (the X input Register #) to another computed value (Y output) according to the graph of the function created. The output of this function (Y) is placed in register 30027 from which it can be routed for use in another control block (Table A, B, or C) where it can be used for controls, or it can be used for Protection Shut Down setpoints (PSD) or Compliance Shut Down setpoints (CSD). This function may also be used to rescale values for reporting in standard engineering units.

23.0 ADVANCED TEMPERATURE MONITORING OPTIONS

23.1 The EPC-100E system includes several advanced temperature monitoring options. Some are provided to better protect the engine or catalyst from thermal damage and some are to better support the current or future EPA requirements for CAM or other emissions compliance regulations. Altronic has characterized the monitoring options as either **PSD (Protection Shut Down)** or **CSD (Compliance Shut Down)**. The identifiers of **PSD** or **CSD** assigned to these setpoints is not meant to limit the use of these individual functions or their outputs, it just identifies which output transistor changes state and how it might be used in one of its typical applications. Likewise, while the names used included the word shutdown, the output switches are also intended to sound alarms or interface to other systems where that is the intended action. Clicking the **TEMPERATURES** tab displays this screen.

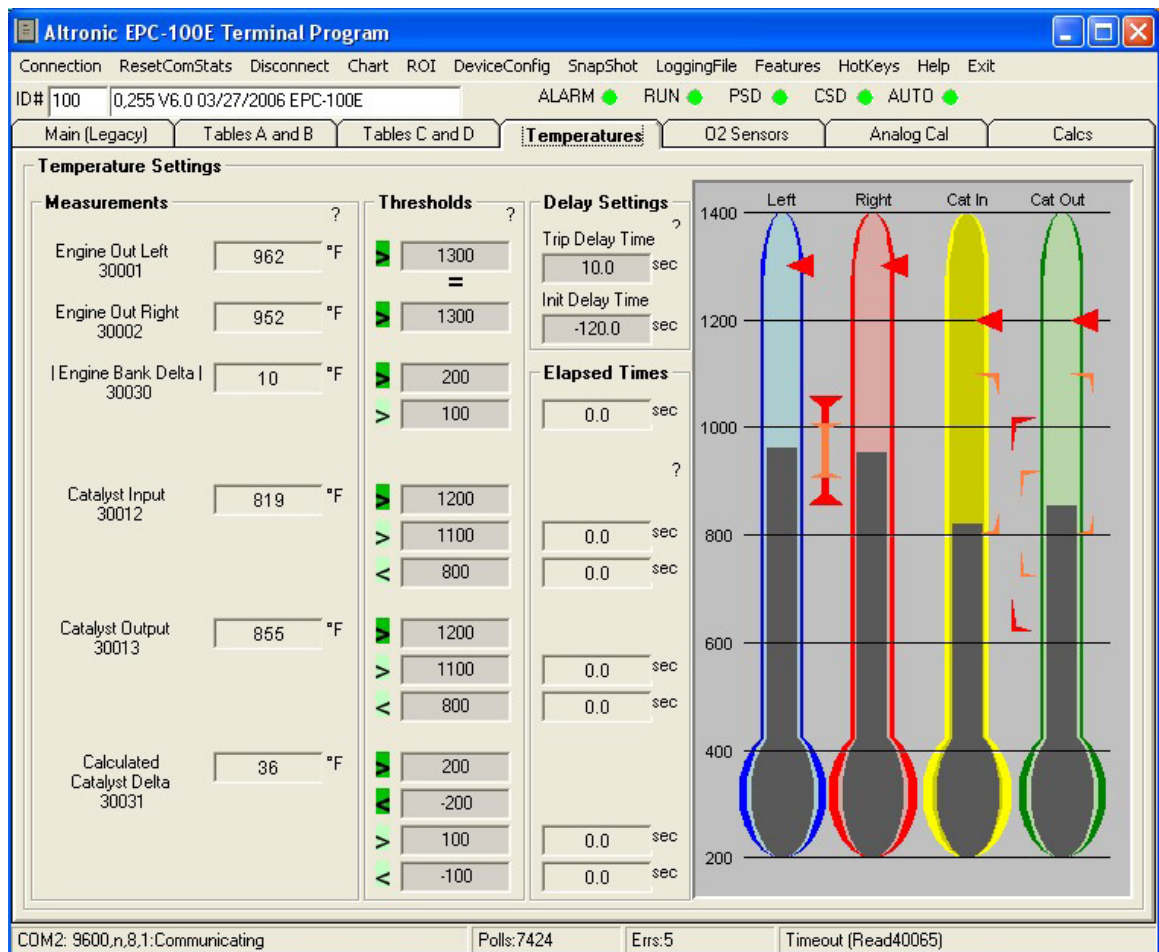

The setpoint relationships shown with the **DARK GREEN >** or **<** are **PSD** functions and they are shown graphically on the right side display by the **RED ARROWS** or **BRACKETS**. The setpoint relationships shown in **LIGHT GREEN** are **CSD** functions and they are shown graphically by the **ORANGE BRACKETS**. The **PSD** setpoints trip **Output B** and the **CSD** setpoints trip **Output C**. Output transistors are normally closed (ON) to ground and turn OFF (open) when tripped.

EPC-100E AIR-FUEL CONTROLLER

As explained previously, **Tool Tips** are provided on all of the screens of this program to help guide the user in its proper application. In order to view the tool tip for a particular entry, place the cursor over the item and allow it to remain motionless for several seconds. The program help as shown in the examples below will appear.

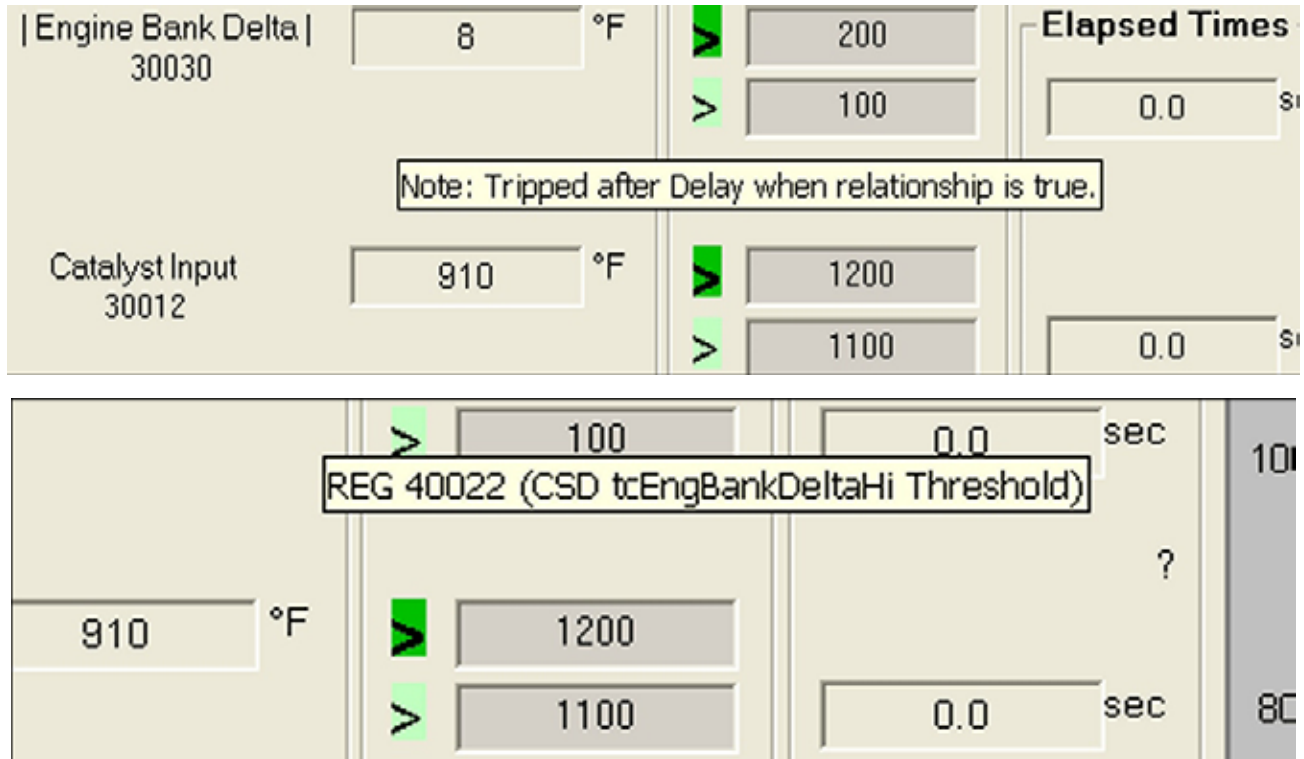

24.0 ADVANCED OXYGEN SENSOR MONITORING OPTIONS

24.1 By selecting the **O2 SENSORS** tab, the user is given the option of implementing a number of advanced **CSD** (Emissions Compliance) functions. All of these functions are intended to alert the operator of a potential problem with the operation of the engine being out of compliance with its permitted emissions limits. The types of problems detected could be with the O2 sensors, some other control system component, the catalyst or even with the engine itself. Since upset conditions will often cause momentary excursions in emissions, all of these functions provide for a user selectable time delay before tripping. The time delay function provided, counts the elapsed time of an excursion by counting up at fixed rate of 10 pulses per second until the delay time is completed and the output trips. If the condition normalizes before the delay assigned to it is completed, the counter will begin to count down at the rate of two counts per second. This interaction of the up/down counting function produces a compliance testing means whereby any single continuous excursion exceeding the setpoint causes an output trip and any repetitive or oscillating condition which is out of compliance for 20% or more of the time also causes the output to trip. Any **CSD** trip will cause the **CSD** indicator to turn from **GREEN** to **ORANGE** and cause the transistor assigned to Output C on the auxiliary terminal strip to turn **OFF**.

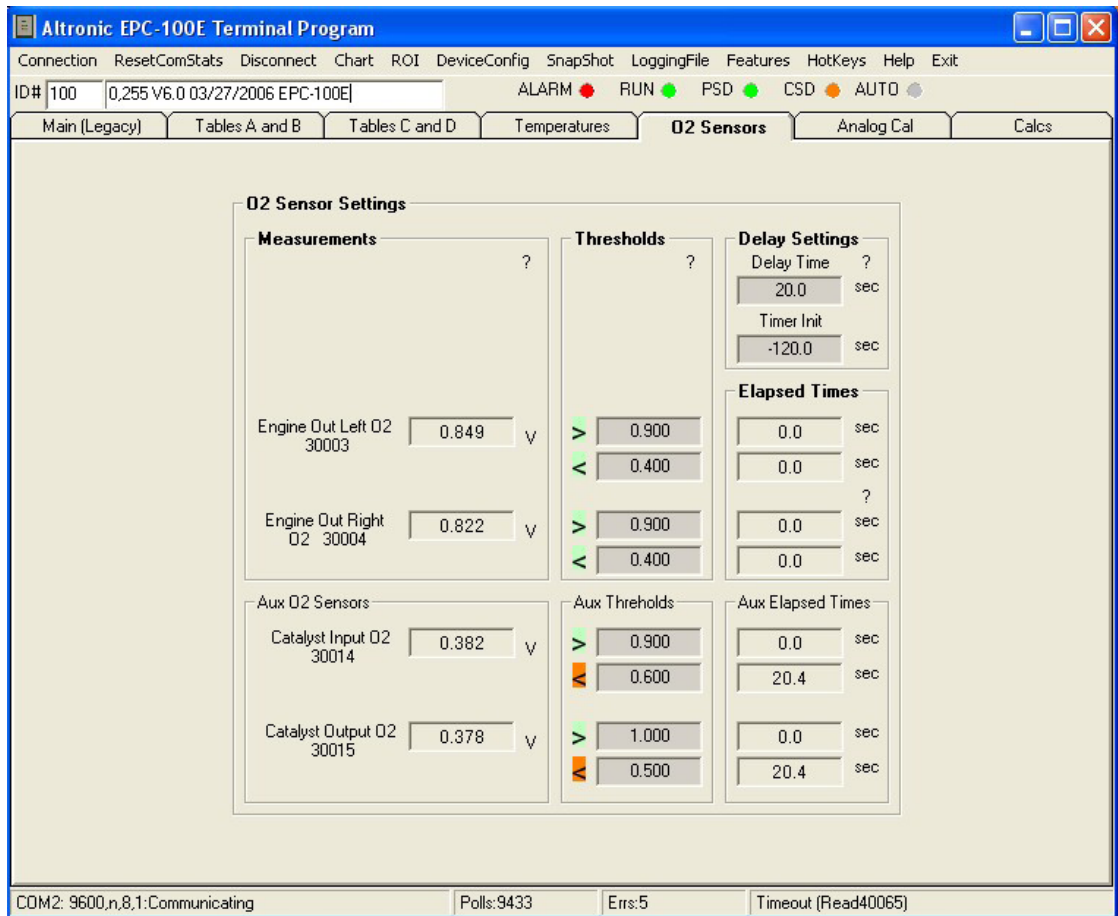

EPC-100E AIR-FUEL CONTROLLER

25.0 CALIBRATION OF THE OPTIONAL ANALOG INPUTS

25.1 The four auxiliary analog inputs are designed for use with virtually any transducers having an output voltage of 0 to 5 volts DC. If current mode transmitters are used, a resistor of 250 ohms or less should be used for termination. These inputs are not prescaled in any engineering units. The range of numeric values for the engineering units is -32,768 to +32,767. The inputs are configured for use with linear signals, if a non-linear transfer function is required, use the **TABLE D** function to process the original data after it is received. The calibration of these inputs allows the user to pick the minimum voltage to be used for calibration and its corresponding engineering units value as well as the maximum calibration voltage and its engineering units value. Additionally, the user can also pick an absolute minimum and maximum engineering units value to be used for calculation and control purposes. Since the calibration values of voltage and engineering units are used to create a straight line approximation of the input, the absolute minimum and maximum values to be used can be placed anywhere along the line. Any input voltage which would then cause the engineering units value to fall beyond these absolute limits will use the limiting value for all calculations.

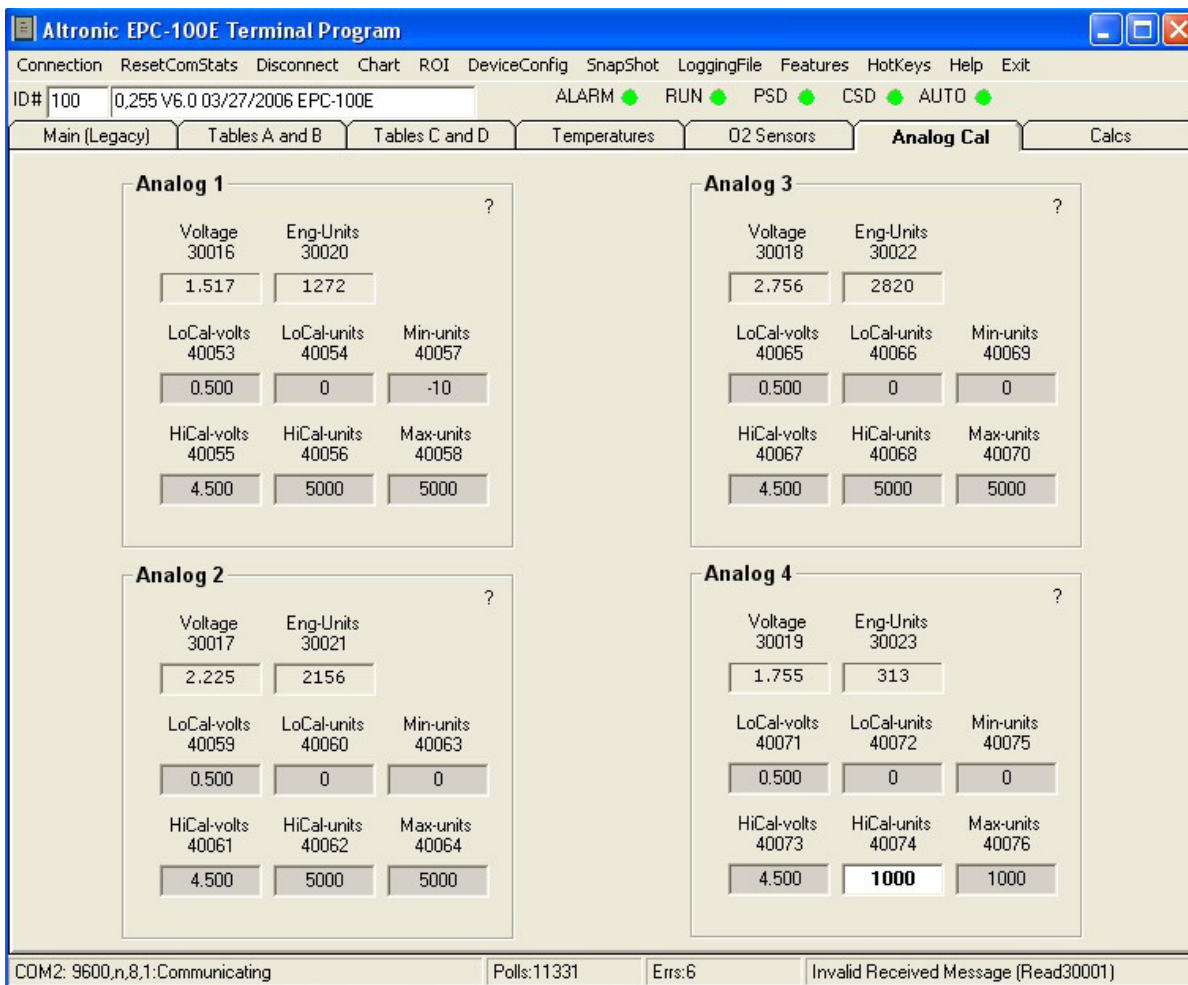

26.0 USING THE OPTIONAL ONBOARD CALCULATIONS

26.1 The last tab on the right is labeled **CALCS** and is used where needed to create custom calculated values for the required control functions. A series of pre-defined function blocks which include the basic math operations is available. The contents of any Modbus register in the 30xxx or 40xxx range can be used as the variables by entering their Reg# into the box provided. Addition, subtraction, multiplication, absolute value and time weighted averaging (filtering) are available. Calculations will be done using the values of the selected registers without regard to the engineering units.

26.2 On the right hand side of the screen above are the Flexible Protection Shut Down and Flexible Compliance Shut Down configuration tables. The user may choose to compare the relationship of the engineering unit values of any of the available registers by selecting the Reg# of desired parameters. The contents of the selected registers will be compared according to the statement shown and if the statement is true will cause the appropriate output **CSD** or **PSD** to trip.

26.3 Lastly, there may be cases where the automatic function of the controller should be inhibited until a certain measured condition or conditions is met. By entering the Reg# of the measured condition into register 40121 its engineering units value will be compared to the numeric value stored in register 40122. If the statement shown is true then the automatic control function will be inhibited. A second set of registers is provided to allow for a “window of operation” between two setpoints or to inhibit control by a second independent parameter.

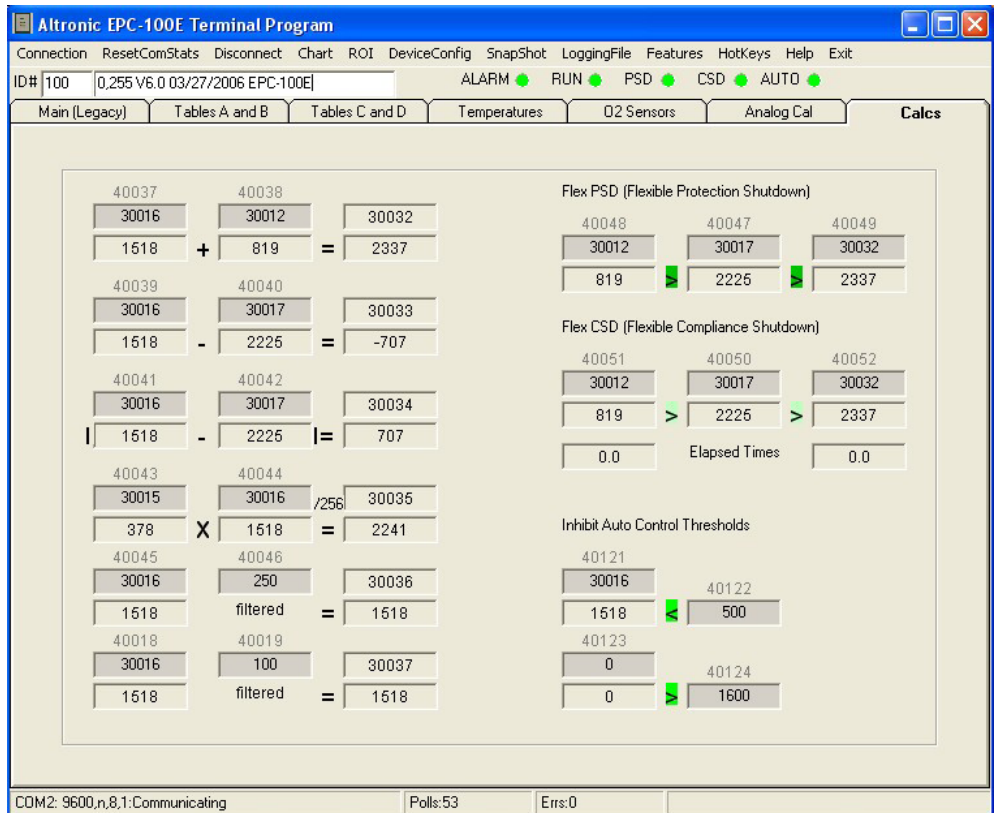

EPC-100E AIR-FUEL CONTROLLER

27.0 EPC-100E MODBUS REGISTER LIST

The EPC-100E incorporates a half-duplex RS-485 or RS232 port which is Modbus RTU slave compliant. The protocol used follows the Modicon Modbus RTU standard. A complete listing of the Modbus registers is included on the EPC-100E Terminal program CD along with a PC-based Modbus-compatible monitoring program. The default configuration for the port is 9600 baud N81 with a node ID of 100. The Modbus communications will allow the EPC-100E to meet the needs of continuous emissions monitoring should it be required.

The 10xxx registers are read-only binary and support Modbus standard function 1. These registers are read in multiples of 8 (1 byte) addressed at each 8 bit boundary (10001-10008, etc.). A single Boolean read from registers 10001 to 10064 can be made which will return all 64 values as a group of 8 bytes. These registers also support an Altronic custom function 101 which will return a descriptive label for each specific register. The custom label function can be used to reduce the need for the Modbus master to maintain a current listing of all of the register labels for each unit.

REGISTER	BINARY REGISTER VALUES
10001	Left Bank Manual Override
10002	Right Bank Manual Override
10003	Left Bank Warm-up
10004	Right Bank Warm-up
10005	Left Bank Stepper Resetting
10006	Right Bank Stepper Resetting
10007	Reserved
10008	Unacknowledged Alarm Preset
10009	Left Bank Exh Temp Low
10010	Left Bank Exh Temp High
10011	Left Bank O2 Signal Low
10012	Left Bank O2 Signal High
10013	Left Aux Auto Inhibit
10014	Left Bank O2 sensor Not Ready
10015	Left Bank Stepper Lean Limit
10016	Left Bank Stepper Rich Limit
10017	Right Bank Exh Temp Low
10018	Right Bank Exh Temp High
10019	Right Bank O2 Signal Low
10020	Right Bank O2 Signal High
10021	Right Aux Auto Inhibit
10022	Right Bank O2 sensor Not Ready
10023	Right Bank Stepper Lean Limit
10024	Right Bank Stepper Rich Limit

REGISTER	BINARY REGISTER VALUES
10025	Right Bank Step Coil Open Pin C
10026	Right Bank Step Coil Open Pin B
10027	Right Bank Step Coil Open Pin A
10028	Right Bank Step Coil Open Pin F
10029	Left Bank Step Coil Open Pin C
10030	Left Bank Step Coil Open Pin B
10031	Left Bank Step Coil Open Pin A
10032	Left Bank Step Coil Open Pin F
10033	Left Auto Control is Active
10034	Left Getting Richer
10035	Left Very Rich Offset >512 mv
10036	Left Rich
10037	Left On Target +/-5 mv
10038	Left Lean
10039	Left Very Lean Offset >512 mv
10040	Left Getting Leaner
10041	Right Auto Control is Active
10042	Right Getting Richer
10043	Right Very Rich Offset >512 mv
10044	Right Rich
10045	Right On Target +/-5 mv
10046	Right Lean
10047	Right Very Lean Offset >512 mv
10048	Right Getting Leaner
10049	Right Bank Step Coil 1 On
10050	Right Bank Step Coil 2 On
10051	Right Bank Step Coil 3 On
10052	Right Bank Step Coil 4 On
10053	Left Bank Step Coil 1 On
10054	Left Bank Step Coil 2 On
10055	Left Bank Step Coil 3 On
10056	Left Bank Step Coil 4 On
10057	Left Stepper Power On
10058	Right Stepper Power On
10059	Reserved
10060	Reserved
10061	Reserved
10062	Reserved
10063	Single Bank Sysytem
10064	Dual Bank System

EPC-100E AIR-FUEL CONTROLLER

REGISTER	BINARY REGISTER VALUES
10065	TC ENG LEFT HI Temp PSD
10066	TC ENG RGHT HI Temp PSD
10067	TC ENG LvsR HI Delta PSD
10068	TC CAT IN HI Temp PSD
10069	TC CAT OUT HI Temp PSD
10070	TC CAT Delta HI Delta PSD
10071	Cat Temp I/O Delta LO PSD
10072	Calc Flex PSD HI/LO
10073	Exh Temp Delta HI L/R CSD
10074	Cat Temp In HI CSD
10075	Cat Temp In LO CSD
10076	Cat Temp Out HI CSD
10077	Cat Temp Out LO CSD
10078	Cat Temp Delta I/O HI CSD
10079	Cat Temp Delta I/O LO CSD
10080	Calc Flex CSD HI/LO
10081	Left Eng O2 HI CSD
10082	Left Eng O2 LO CSD
10083	Right Eng O2 HI CSD
10084	Right Eng O2 LO CSD
10085	Left Bank Step Coil 1 On
10086	Cat In O2 LO CSD
10087	Left Bank Step Coil 3 On
10088	Cat Out O2 LO CSD
10089	no function
10090	no function
10091	no function
10092	OUTPUT ALARM legacy ALM +PSD
10093	Output A, Logic1 is ON, Running
10094	OUTPUT A CATALYST ALARM
10095	Output C, Logic1 is ON, No CSD
10096	OUTPUT B Auto Operation Active

The 30xxx registers are read-only, 16 bit, analog values. The Modbus standard function 4 is supported. These registers also support an Altronic custom function 104 which will return a descriptive label for each specific register.

REGISTER	16-BIT INPUT REGISTER VALUES	
30001	Left Exh TC Temp	1 deg F/cnt
30002	Right Exh TC Temp	1 deg F/cnt
30003	Left Exh O2 Volt	1 mv/cnt
30004	Right Exh O2 Volt	1 mv/cnt

REGISTER	16-BIT INPUT REGISTER VALUES	
30005	Left Stepper Position	
30006	Right Stepper Position	
30007	CJT Deg C	+/- 0.01 deg C/cnt
30008	Supply Voltage	0.1 v/cnt
30009	Logic Voltage	1 mv/cnt
30010	Left Est. LAMBDA	.01/cnt
30011	Right Est. LAMBDA	.01/cnt
30012	CATALYST IN TC	1 deg F/cnt
30013	CATALYST OUT TC	1 deg F/cnt
30014	Left AUX O2	1mv/cnt
30015	Right AUX O2	1mv/cnt
30016	Aux 1 0-5 Ratiometric	1mv/cnt
30017	Aux 2 0-5 Ratiometric	1mv/cnt
30018	Aux 3 0-5 Ratiometric	1mv/cnt
30019	Aux 4 0-5 Ratiometric	1mv/cnt
30020	Aux 1 Engineering value	
30021	Aux 2 Engineering value	
30022	Aux 3 Engineering value	
30023	Aux 4 Engineering value	
30024	Lookup Table A result	
30025	Lookup Table B result	
30026	Lookup Table C result	
30027	Lookup Table D result	
30028	Left O2 Dynamic Target	1mv/cnt
30029	Right O2 Dynamic Target	1mv/cnt
30030	EXHAUST TEMP DELTA	LEFT-RGHT
30031	CATALYST TEMP RISE	(OUT-IN)
30032	Calculator, signed sum	
30033	Calculator, signed difference	
30034	Calculator, absolute difference	
30035	Calculator, x times y divided by 256	
30036	Calculator, signed filter 1	
30037	Calculator, signed filter 2	
30038	Control gain with dynamic offset	
30047	Compliance SD Calc LT timer	
30048	Compliance SD GT timer	
30049	CSD left/right Temp Delta time	0.1s
30050	CSD Cat In Temp HI time	0.1s
30051	CSD Cat In Temp LO time	0.1s
30052	CSD Cat Out Temp HI time	0.1s

EPC-100E AIR-FUEL CONTROLLER

REGISTER	16-BIT INPUT REGISTER VALUES	
30053	CSD Cat Out Temp LO time	0.1s
30054	CSD Cat Delta Temp HI time	0.1s
30055	CSD Cat Delta Temp LO time	0.1s
30056	CSD left bank O2 HI time	0.1s
30057	CSD left bank O2 LO time	0.1s
30058	CSD right bank O2 HI time	0.1s
30059	CSD right bank O2 LO time	0.1s
30060	CSD Cat In O2 HI time	0.1s
30061	CSD Cat In O2 LO time	0.1s
30062	CSD Cat Out O2 HI time	0.1s
30063	CSD Cat Out O2 LO	0.1s
30064	Loop timer 0	
30083	Spare	
30084	Cause of NOT AUTO condition	
30085	Autolog Left Eng Exh Temp	
30086	Autolog Right Eng Exh Temp	
30087	Autolog Left Eng O2	
30088	Autolog Right Eng O2	
30089	Autolog Left Stepper Position	
30090	Autolog Right Stepper Position	
30091	Autolog Left Aux TC	
30092	Autolog Right Aux TC	
30093	Autolog Aux1 O2	m v
30094	Autolog Aux2 O2	m v
30095	Autolog Analog 1	m v
30096	Autolog Analog 2	m v
30097	Autolog Analog 3	m v
30098	Autolog Analog 4	m v
30099	Aux TCR - Aux TCL	°F
30100	Aux 3 - AUX 4	mv
30101	CJT Comp	1 uv/cnt
30102	A/D 0 Filtr	2.5 v reference
30103	A/D 1 Filtr supply voltage	
30104	A/D 2 Filtr	vss
30105	A/D 3 CJT	
30106	A/D 4 O2 Right Legacy	
30107	A/D 5 O2 Left Legacy	
30108	A/D 6 TC Right Legacy	
30109	A/D 7 TC Left Legacy	
30110	A/D 8 TC Right Aux	
30111	A/D 9 TC Left Aux	

REGISTER	16-BIT INPUT REGISTER VALUES	
30112	A/D O2 Right Aux	
30113	A/D B O2 Left Aux	
30114	A/D C Sensor 1 Aux	0-5v
30115	A/D D Sensor 2 Aux	0-5v
30116	A/D E Sensor 3 Aux	0-5v
30117	A/D F Sensor 4 Aux	0-5v
30118	Calc filter + 32768	
30119	Calc filter 2 + 32768	
30120	Spare	
30127	Warm-Boot Counter	
30128	Cold-Boot Counter	

The 40xxx registers are read/write, 16-bit, analog values and they support the Modbus standard functions 3, 6 and 16. These registers may have new values written to them in order to make setpoint adjustments from a remote location. They also support a custom function 103 which will return a label describing each specific register.

REGISTER	16-BIT READ/WRITE REGISTER VALUES	
40001	Left Bank O2 Target	mV
40002	Right Bank O2 Target	mV
40003	Left Bank Start Position	steps
40004	Right Bank Start Position	steps
40005	Control Gain Rate	value/40
40006	Exh Temp HI Alarm	deg F
40007	Exh Temp LO Alarm	deg F
40008	Exh O2 HI Alarm Setpoint	mV
40009	Exh O2 LO Alarm Setpoint	mV
40010	Exh O2 Ready HI Setpoint	mV
40011	Exh O2 Ready LO Setpoint	mV
40012	TC ENGOUT HI PSD	degF
40013	TC ENG LvsR HI PSD	degF
40014	TC CAT IN HI PSD	degF
40015	TC CAT OUT HI PSD	degF
40016	TC CAT DELTA HI PSD	degF
40017	PSD Cat Temp Delta I/O LO	°F
40018	Calculator Input A Reg#	Filtered
40019	Calculator Filter Value 0 to 255	
40020	PSD Eng Out Temp HI	°F
40021	PSD Eng Out Temp L/R Delta HI	°F
40022	CSD Eng Out Temp Delta L/R	°F
40023	CSD Cat In Temp HI	°F

EPC-100E AIR-FUEL CONTROLLER

REGISTER	16-BIT READ/WRITE REGISTER VALUES	
40024	CSD Cat In Temp LO	°F
40025	CSD Cat Out Temp HI	°F
40026	CSD Cat Out Temp LO	°F
40027	CSD Cat Temp Delta I/O HI	°F
40028	CSD Cat Temp Delta I/O LO	°F
40029	CSD O2 Delay Time to Trip	sec
40030	CSD O2 Start-up Disable Time	sec
40031	CSD Eng Out O2 Setpoint HI	mV
40032	CSD Eng Out O2 Setpoint LO	mV
40033	CSD Cat In O2 Setpoint HI	mV
40034	CSD Cat In O2 Setpoint LO	mV
40035	CSD Cat Out O2 Setpoint HI	mV
40036	CSD Cat Out O2 Setpoint LO	mV
40037	Calculator Term A Reg#	A + B
40038	Calculator Term B Reg#	A + B
40039	Calculator Term A Reg#	A - B
40040	Calculator Term B Reg#	A - B
40041	Calculator Term A Reg#	A - B
40042	Calculator Term B Reg#	A - B
40043	Calculator Term A Reg#	(AxB)/256
40044	Calculator Term B Reg#	(AxB)/256
40045	Calculator Term A Reg#	Filtered
40046	Calculator Filter Value	0 to 255
40047	Flex PSD Term B Reg#	A>B>C
40048	Flex PSD Term A Reg#	A>B>C
40049	Flex PSD Term C Reg#	A>B>C
40050	Flex CSD Term B Reg#	A>B>C
40051	Flex CSD Term A Reg#	A>B>C
40052	Flex CSD Term C Reg#	A>B>C
40053	Analog1 Low Cal Volts	0 to 5000 mv
40054	Ana1 Cal LO units	-32768 to 32767
40055	Analog1 High Cal Volts	0 to 5000 mv
40056	Ana1 HI Cal units	-32768 to 32767
40057	Analog1 Abs Min Value	
40058	Analog1 Abs Max Value	
40059	Analog2 Low Cal Volts	0 to 5000 mv
40060	Ana2 Cal LO units	-32768 to 32767
40061	Analog2 High Cal Volts	0 to 5000 mv
40062	Ana2 Cal HI units	
40063	Analog2 Abs Min Value	

REGISTER	16-BIT READ/ WRITE REGISTER VALUES
40064	Analog2 Abs Max Value
40065	Analog3 Low Cal Volts 0 to 5000 mv
40066	Ana3 Cal LO units -32768 to 32767
40067	Analog3 High Cal Volts 0 to 5000 mv
40068	Ana3 Cal HI units -32768 to 32767
40069	Analog3 Abs Min Value
40070	Analog3 Abs Max Value
40071	Analog4 Low Cal Volts 0 to 5000 mv
40072	Ana4 Cal LO units -32768 to 32767
40073	Analog4 High Cal Volts 0 to 5000 mv
40074	Ana4 Cal HI units -32768 to 32767
40075	Analog4 Abs Min Value
40076	Analog4 Abs Max Value
40077	Table A Source Reg# for "X value"
40078	Table A Value "X1"
40079	Table A Value "Y1"
40080	Table A Value "X2"
40081	Table A Value "Y2"
40082	Table A Value "X3"
40083	Table A Value "Y3"
40084	Table A Value "X4"
40085	Table A Value "Y4"
40086	Table A Value "X5"
40087	Table A Value "Y5"
40088	Table B Source Reg# for "X value"
40089	Table B Value "X1"
40090	Table B Value "Y1"
40091	Table B Value "X2"
40092	Table B Value "Y2"
40093	Table B Value "X3"
40094	Table B Value "Y3"
40095	Table B Value "X4"
40096	Table B Value "Y4"
40097	Table B Value "X5"
40098	Table B Value "Y5"
40099	Table C Source Reg# for "X value"
40100	Table C Value "X1"
40101	Table C Value "Y1"
40102	Table C Value "X2"
40103	Table C Value "Y2"
40104	Table C Value "X3"

EPC-100E AIR-FUEL CONTROLLER

REGISTER	16-BIT READ/WRITE REGISTER VALUES
40105	Table C Value "Y3"
40106	Table C Value "X5"
40107	Table C Value "Y5"
40108	Table D Source Reg# for "X value"
40109	Table D Value "X1"
40110	Table D Value "Y1"
40111	Table D Value "X2"
40112	Table D Value "Y2"
40113	Table D Value "X3"
40114	Table D Value "Y3"
40115	Table D Value "X4"
40116	Table B Value "Y4"
40117	Table D Value "X5"
40118	Table B Value "Y5"
40119	Spare
40120	Spare
40121	Inhibit Auto Control Term A Reg#
40122	Inhibit < Value of A 0 to 32767
40123	Inhibit Auto Control Term B Reg#
40124	Inhibit > Value of B 0 to 32767
40125	Outputs D=128 C=64 B=32 A=16
40126	Modbus Port Config Code
40127	Modbus Node ID / Slave ID
40128	Modbus Key Command Register

Detailed below are the command values which can be written to the Modbus Key Command Register (40128).

1. Reg(40128) 00510 Select auto mode for both banks
2. Reg(40128) 00765 Select manual mode for left bank
3. Reg(40128) 01020 Select manual mode for right bank
4. Reg(40128) 01275 F1-Start stepper reset
5. Reg(40128) 01530 Alarm acknowledge
6. Reg(40128) 01785 Decrement left O2 target
7. Reg(40128) 02040 Increment left O2 target
8. Reg(40128) 02295 Decrement right O2 target
9. Reg(40128) 02550 Increment right O2 target
10. Reg(40128) 02805 Decrement control gain rate
11. Reg(40128) 03060 Increment control gain rate
12. Reg(40128) 03315 Reload calibration defaults
13. Reg(40128) 03570 Update left start position with current pos
14. Reg(40128) 03825 Update right start position with current pos
20. Reg(40128) 05355 Manual move left stepper rich (- 25)
21. Reg(40128) 05610 Manual move left stepper lean (+ 25)
22. Reg(40128) 05865 Manual move left stepper rich (-100)
23. Reg(40128) 06120 Manual move left stepper lean (+100)
24. Reg(40128) 06375 Manual move right stepper rich (- 25)
25. Reg(40128) 06630 Manual move right stepper lean (+ 25)
26. Reg(40128) 06885 Manual move right stepper rich (-100)
27. Reg(40128) 07140 Manual move right stepper lean (+100)

The EPC-100E unit also supports a Modbus function 17 which will return the unit information including the Version, Date and Name.

30. Reg(40128) 07905 decrement Hi Exhaust Temp Threshold
31. Reg(40128) 08160 increment Hi Exhaust Temp Threshold
32. Reg(40128) 08415 decrement Hi Exhaust Temp Delta Threshold
33. Reg(40128) 08670 increment Hi Exhaust Temp Delta Threshold
34. Reg(40128) 08925 decrement Hi Catalyst Temp In Threshold
35. Reg(40128) 09180 increment Hi Catalyst Temp In Threshold
36. Reg(40128) 09435 decrement Hi Catalyst Temp Out Threshold
37. Reg(40128) 09690 increment Hi Catalyst Temp Out Threshold
38. Reg(40128) 09945 decrement Hi Catalyst Rise Temp Threshold
39. Reg(40128) 10200 increment Hi Catalyst Rise Temp Threshold
199. Reg(40128) 51118 autolog reset
200. Reg(40128) 51256 increase modportcfg
201. Reg(40128) 51511 decrease modportcfg
202. Reg(40128) 51766 increase modidcode
203. Reg(40128) 52021 decrease

EPC-100E AIR-FUEL CONTROLLER

28.0 CHARTING THE VALUES OF THE MEASURED VARIABLES

28.1 The EPC-100E Terminal program allows the user the option of displaying the measured variables in a strip chart form as shown below. This type of display can be very useful to analyze large amounts of data quickly or to detect operating trends over time. To turn on this display click on the word **CHART** on the top toolbar. Scales can be expanded or compressed using the mouse to “drag” the small white boxes on each axis.

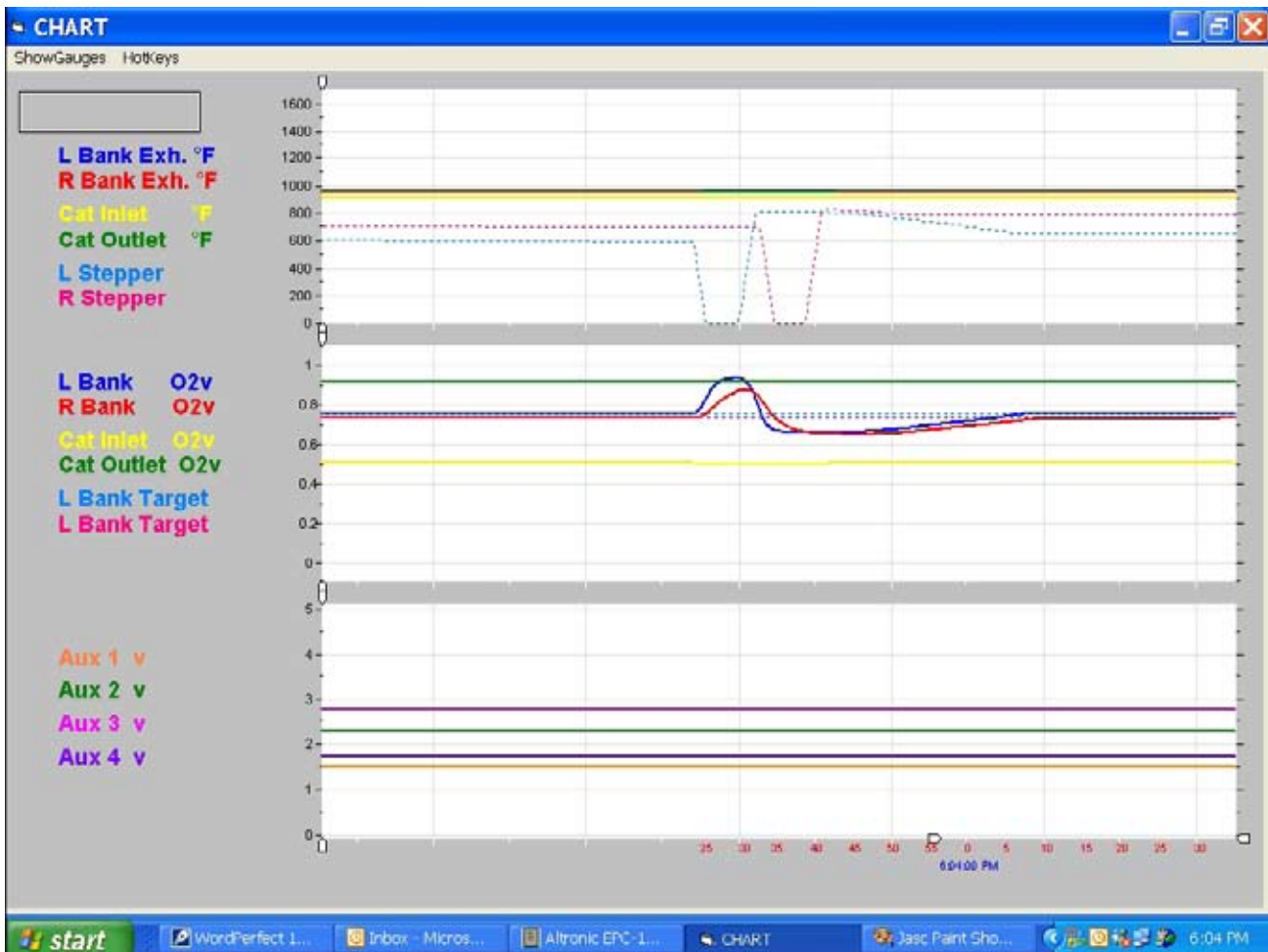

Note: Do not attempt to modify communications setup values using ROI or communications will be lost until the computer is reset to the new values.

29.0 ROI – THE REMOTE OPERATING INTERFACE

29.1 ROI (Remote Operating Interface) provides the user of the terminal with a direct interface to the EPC-100E keypad and display, just as if they were at the location. When using the **ROI** option, any function normally available at the keypad will execute and display in same manner as if the local keys were actually pressed. At the site where the EPC-100E unit is operating, the **ROI** function will appear to be keypad operation by an invisible operator.

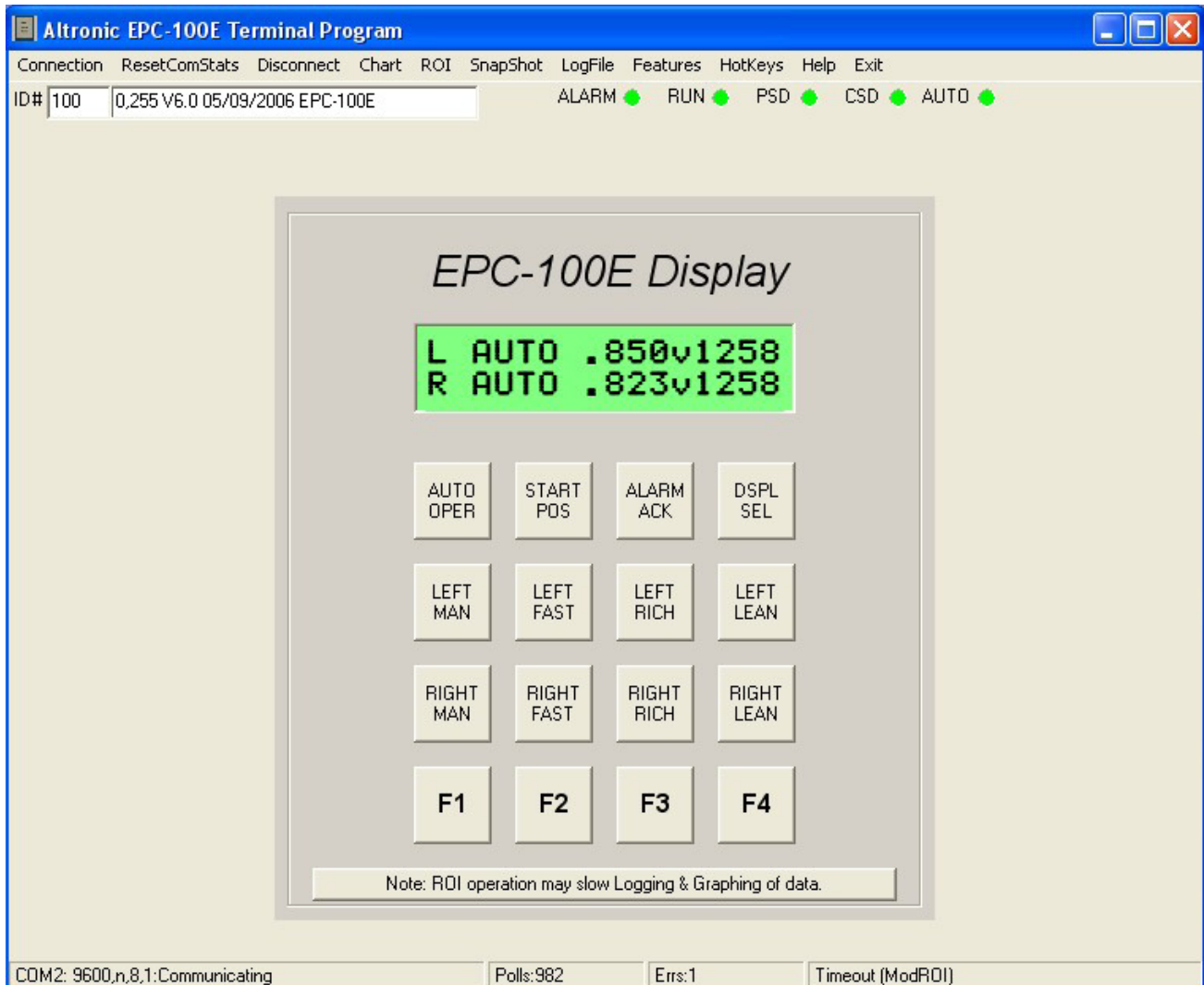

EPC-100E AIR-FUEL CONTROLLER

30.0 OTHER TOOLBAR OPTIONS

30.1 There are some additional toolbar functions not covered elsewhere in this document, the operation of each of these is explained below.

- **ResetComStats:** Clears the Modbus communications error counter to zero. This can be very useful when troubleshooting communication problems.
- **Connect/Disconnect:** Connects/disconnects the computer from the EPC-100E.
- **Snapshot:** Creates a snapshot of the current screen display on the computer to be saved in a *.jpg file. This captures the gauge or the chart display whichever one is active.
- **LogFile:** Allows for the selection of automatic data logging on the computer connected to the EPC-100E. Datalogs are Excel compatible, CSV type (comma separated values).
- **HotKeys:** Gives access from any screen to turn on Chart display or to Enable remote control via Modbus.
- **Help:** Displays Software Version and dates.
- **Exit:** Disconnects EPC-100E from computer and exits this program.

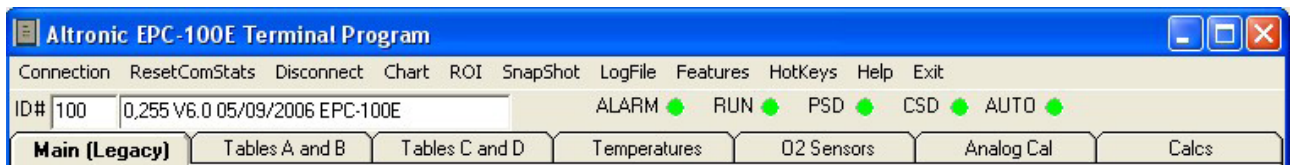

FIGURES SECTION:

- FIG. 1** GENERAL INSTALLATION LAYOUT
- FIG. 2** MOUNTING DETAIL
- FIG. 3** OXYGEN SENSOR DETAIL
- FIG. 4** BASIC WIRE ROUTING DETAIL
- FIG. 5** MODBUS COMMUNICATION CONNECTIONS
- FIG. 6** BASIC TERMINAL LAYOUT
- FIG. 7** TERMINAL LAYOUT FOR EXPANDED FEATURE I/O
- FIG. 8** TYPICAL O₂ SENSOR RESPONSE
- FIG. 9** EPC-100E PARTS BREAKDOWN
- FIG. 10** EPC-100E PARTS IDENTIFICATION
- FIG. 11** EPC-100E ACCESSORY KIT IDENTIFICATION

EPC-100E AIR-FUEL CONTROLLER

FIG. 1 GENERAL INSTALLATION LAYOUT

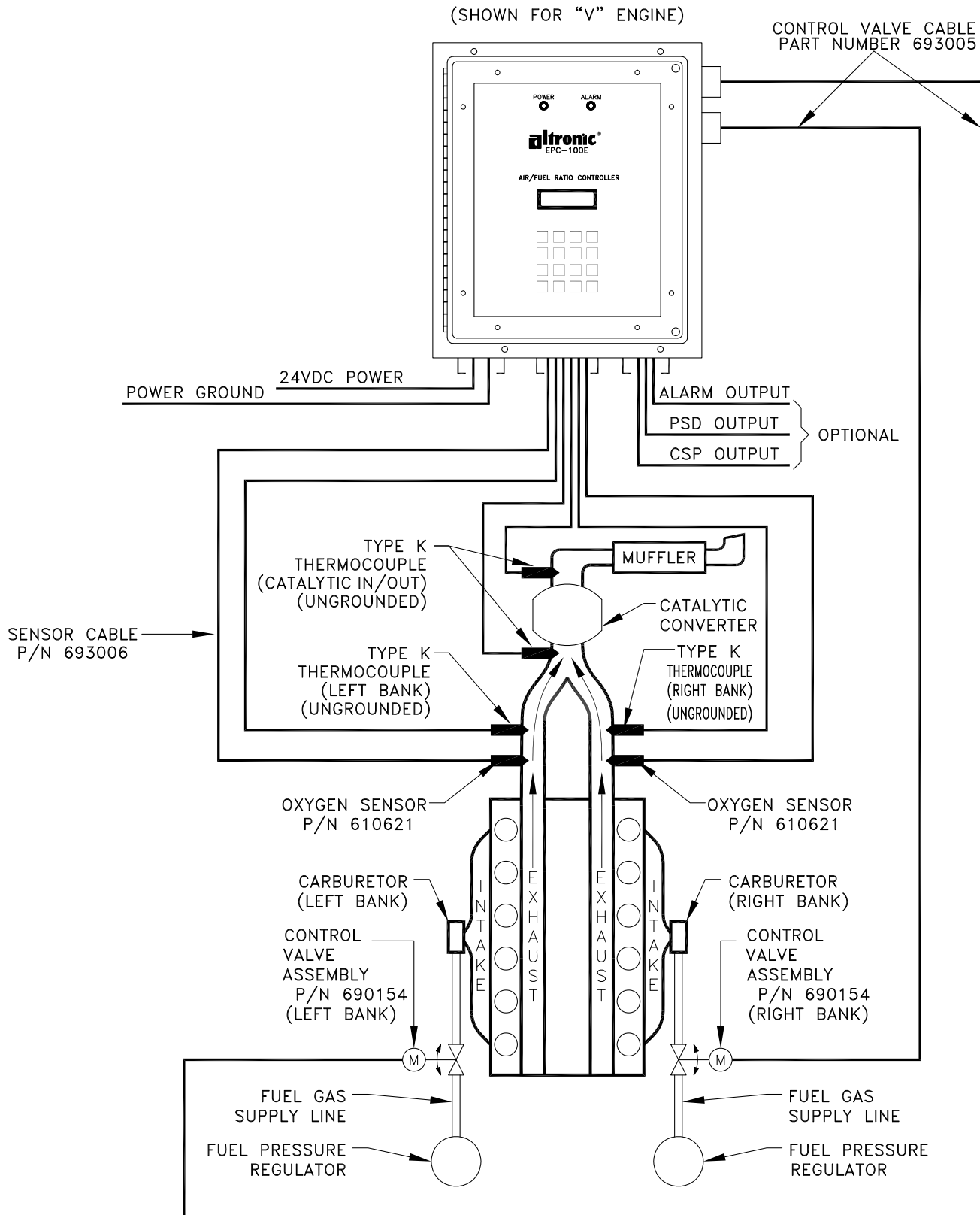
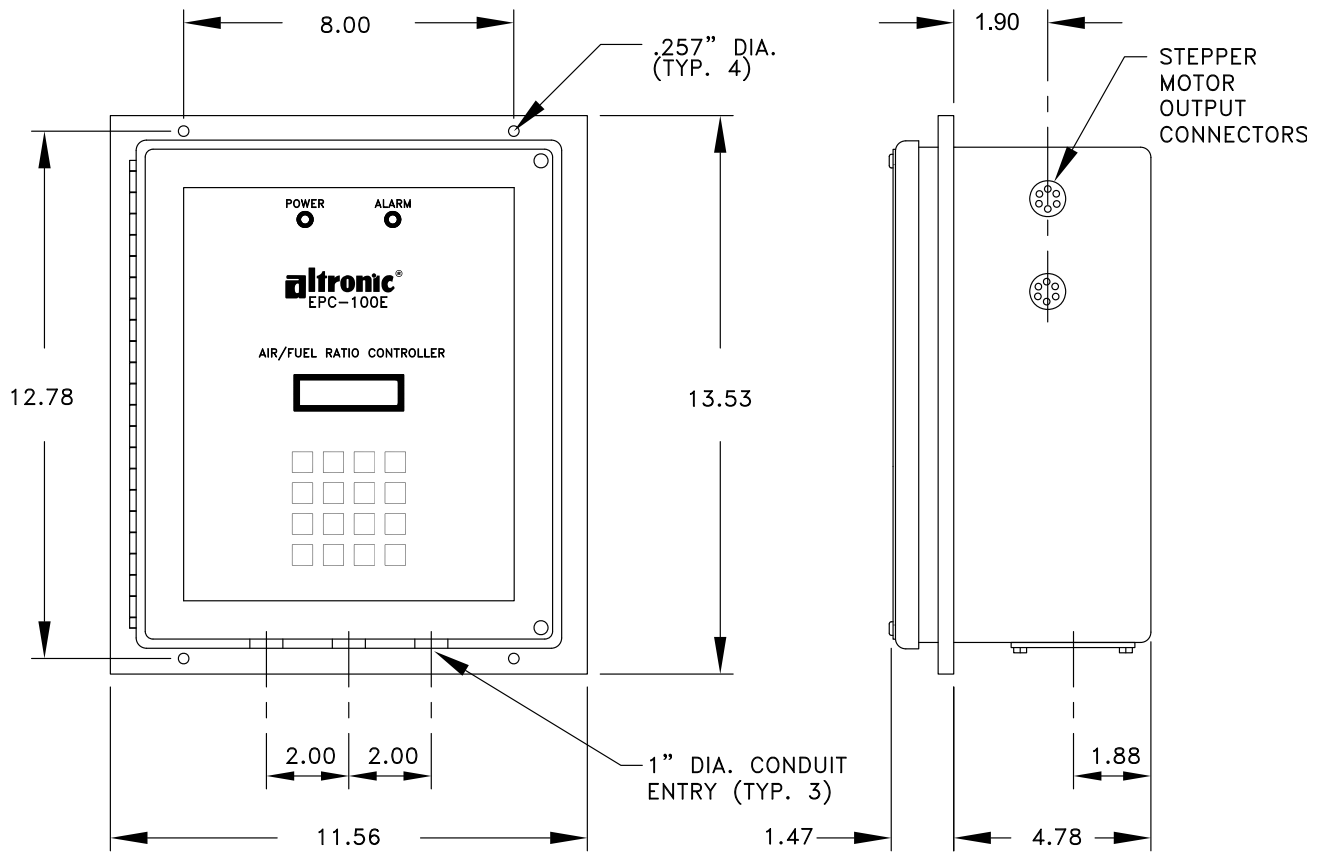

FIG. 3 MOUNTING DETAIL



NOTE: PANEL CUT-OUT IS 10.12" X 12.12"
ALL DIMENSIONS ARE IN INCHES.

EPC-100E AIR-FUEL CONTROLLER

FIG. 3 OXYGEN SENSOR DETAIL

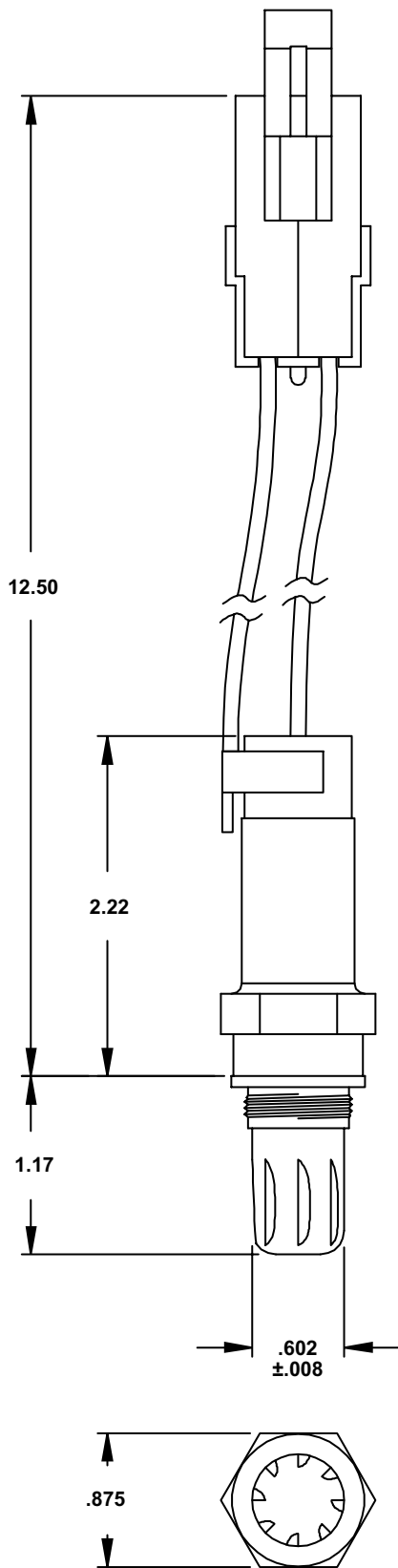

CONNECTOR PIN	WIRE COLOR	PIN AND WIRE CONNECTION
A	TAN	SENSOR (GROUND)
B	BLACK	OUTPUT

MATING CONNECTOR:
PACKARD ELECTRIC DIV. PART NO. 12010501

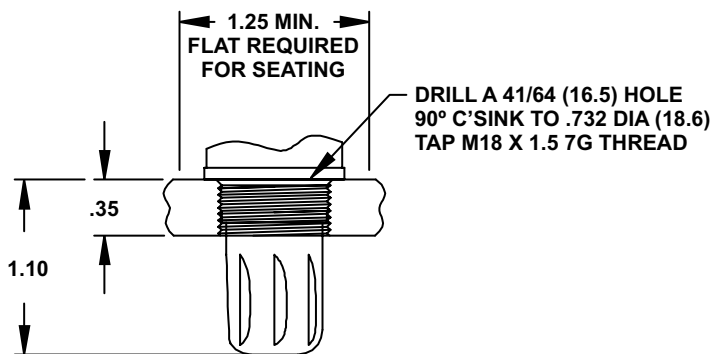

RECOMMENDED INSTALLATION DIMENSIONS

INSTALLATION INSTRUCTIONS:

1. INSTALL IN THE APPROPRIATE MOUNTING HOLE TO A TORQUE OF 28-34 LB. FT.
2. USE A 7/8" WRENCH SIZE.
3. SENSORS ARE TO BE SUPPLIED WITH THREADS COATED WITH MS-0572 ANTISEIZE COMPOUND. CAUTION: DO NOT APPLY ANTISEIZE COMPOUND TO AREAS OTHER THAN THE MOUNTING THREADS.
4. FOR OPTIMUM RESISTANCE TO WATER INTRUSION, AC RECOMMENDS MOUNTING SENSORS SUCH THAT THE EXPOSED END (WIRE END) OF THE SENSOR IS ORIENTED AT OR ABOVE HORIZONTAL.
5. THIS SENSOR IS DESIGNED FOR WATER SPLASH RESISTANCE.

FIG. 4 BASIC WIRE ROUTING DETAIL

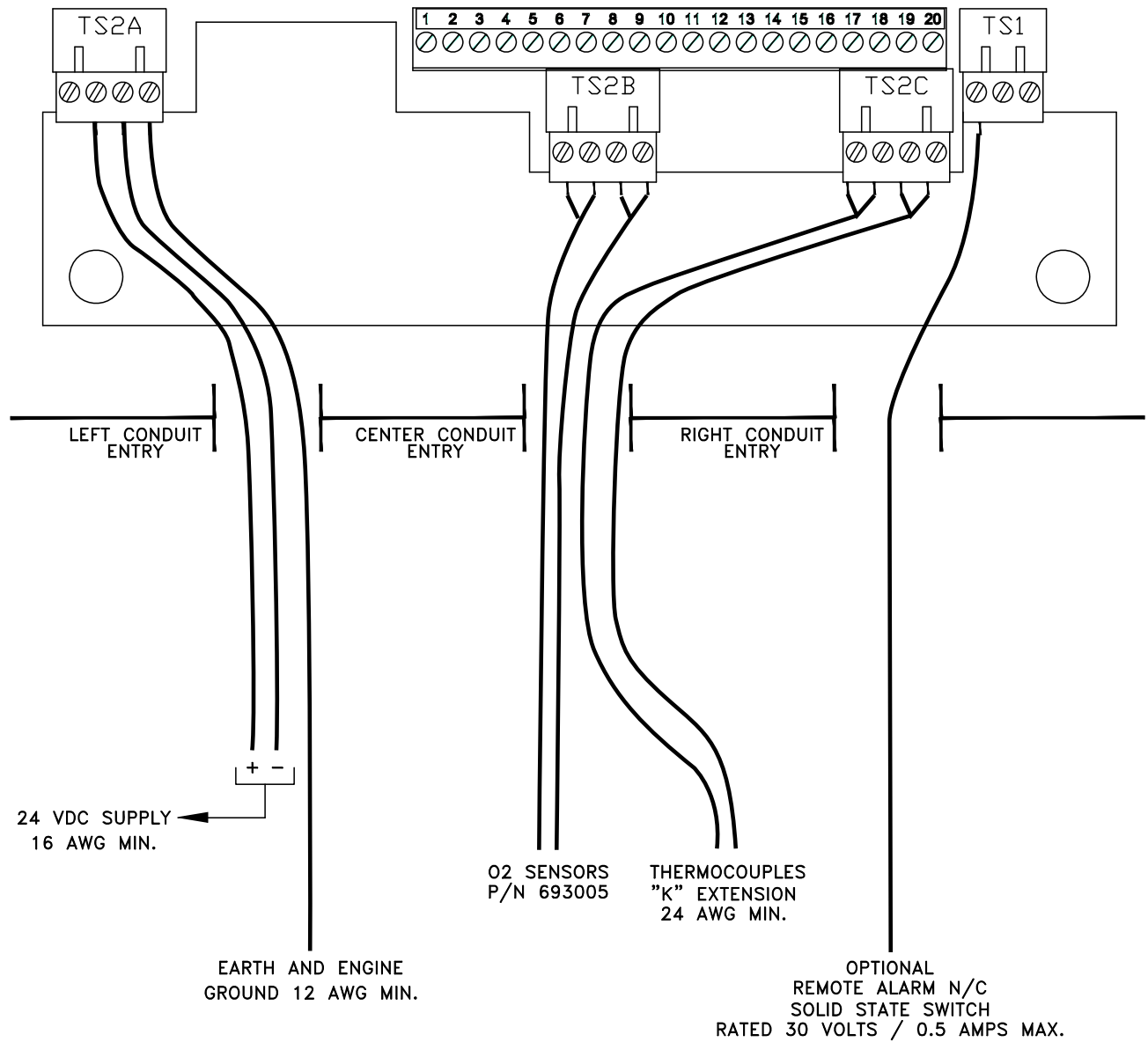

NOTE: DO NOT ROUTE WIRES INTO UNIT IN ANY OTHER MANNER. MAINTAIN SEPARATION AFTER LEAVING ENCLOSURE. IF CONDUIT IS USED, THREE SEPARATE CONDUITS ARE REQUIRED.

EPC-100E AIR-FUEL CONTROLLER

FIG. 5 MODBUS COMMUNICATION CONNECTIONS

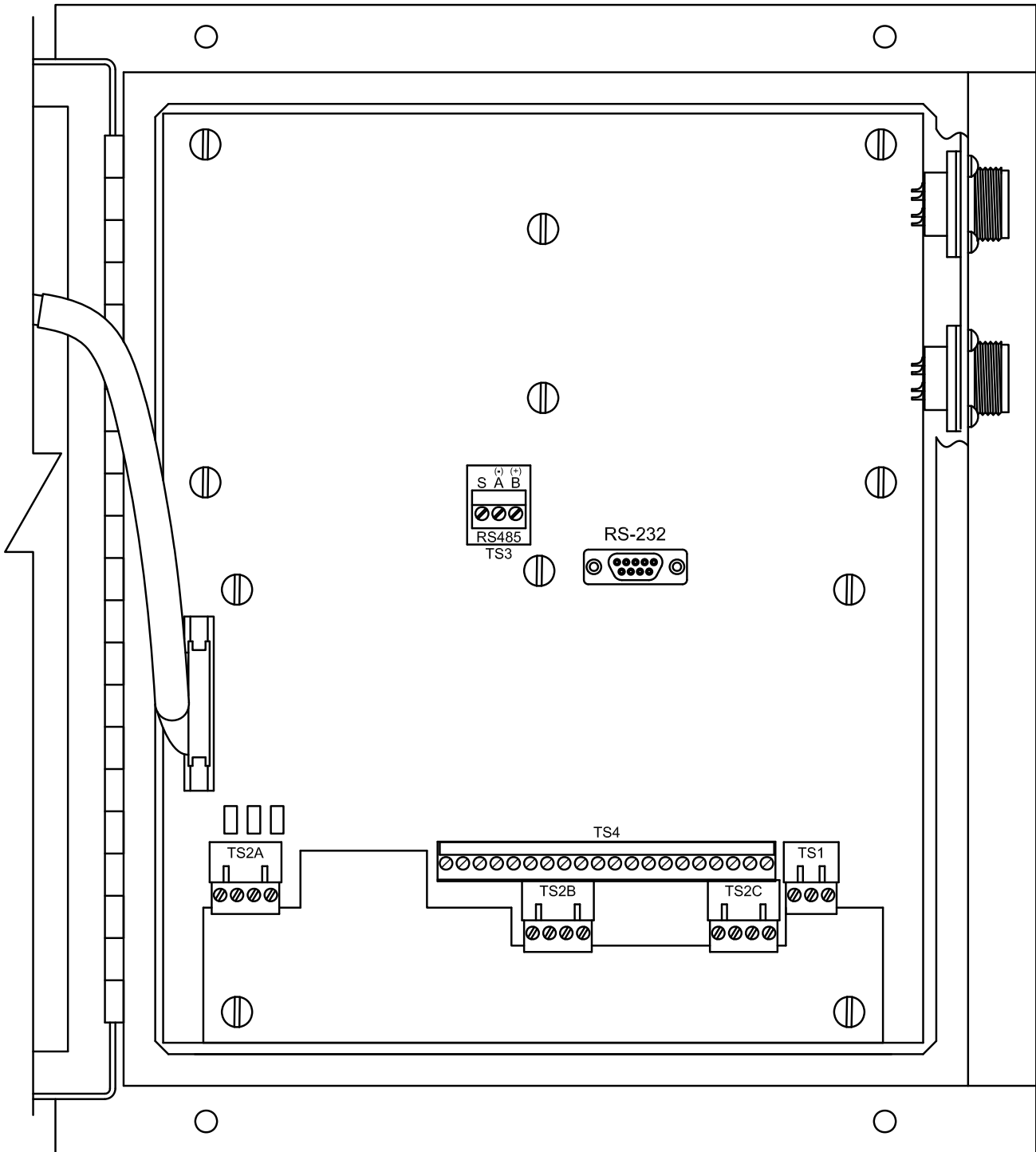
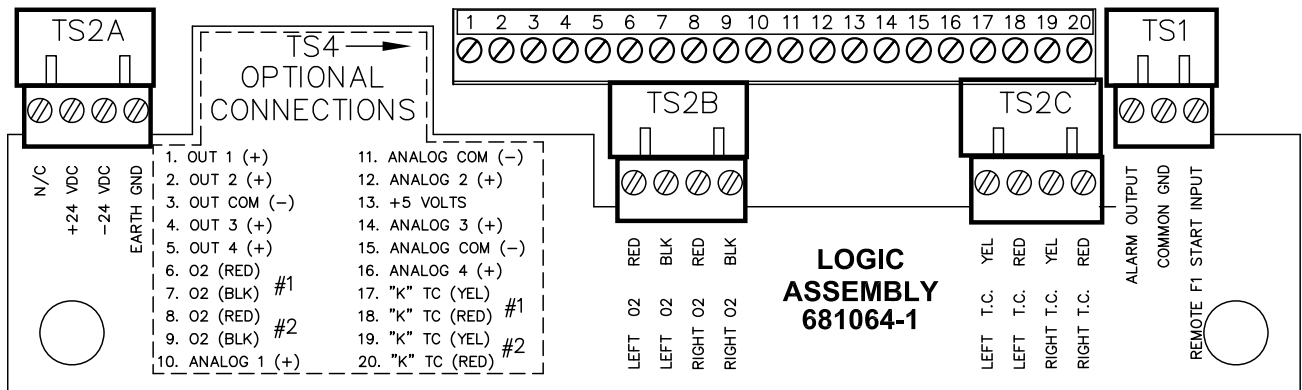

FIG. 6 BASIC TERMINAL LAYOUT



TS2A

- +24 VDC POSITIVE LEAD OF THE D.C. POWER SOURCE.
- 24 VDC NEGATIVE LEAD OF THE D.C. POWER SOURCE.
- EARTH GND EARTH GROUND ALSO CONNECTED TO ENGINE GROUND.

TS2B

- * LEFT O2 RED POSITIVE LEAD OF 693006 CONNECTED TO LEFT SENSOR.
 - * LEFT O2 BLACK NEGATIVE LEAD OF 693006 CONNECTED TO LEFT SENSOR.
 - RIGHT O2 RED POSITIVE LEAD OF 693006 CONNECTED TO RIGHT SENSOR.
 - RIGHT O2 BLACK NEGATIVE LEAD OF 693006 CONNECTED TO RIGHT SENSOR.
- NOTE: SHIELD OF 693006 CABLE TERMINATES AT SENSOR END TO EXHAUST.

TS2C

- * LEFT T.C. YELLOW POSITIVE LEAD OF "K" EXTENSION WIRE CONNECTED TO LEFT THERMOCOUPLE.
- * LEFT T.C. RED NEGATIVE LEAD OF "K" EXTENSION WIRE CONNECTED TO LEFT THERMOCOUPLE.
- RIGHT T.C. YELLOW POSITIVE LEAD OF "K" EXTENSION WIRE CONNECTED TO RIGHT THERMOCOUPLE.
- RIGHT T.C. RED NEGATIVE LEAD OF "K" EXTENSION WIRE CONNECTED TO RIGHT THERMOCOUPLE.

TS1

- ALARM OUTPUT POSITIVE LEAD, N/C TO GROUND. OPEN FOR ALARM.
- COMMON GND COMMON RETURN FOR F1 START INPUT.
- REMOTE F1 START INPUT MOMENTARILY GROUND FOR F1 START.

* NOTE: IN-LINE OR SINGLE CARBURETOR APPLICATIONS USE LEFT BANK CONNECTIONS ONLY. SELECT SINGLE OR DUAL BANK USING SETUP MENU.

EPC-100E AIR-FUEL CONTROLLER

FIG. 7 TERMINAL LAYOUT FOR ADVANCED CONTROL OPTIONS

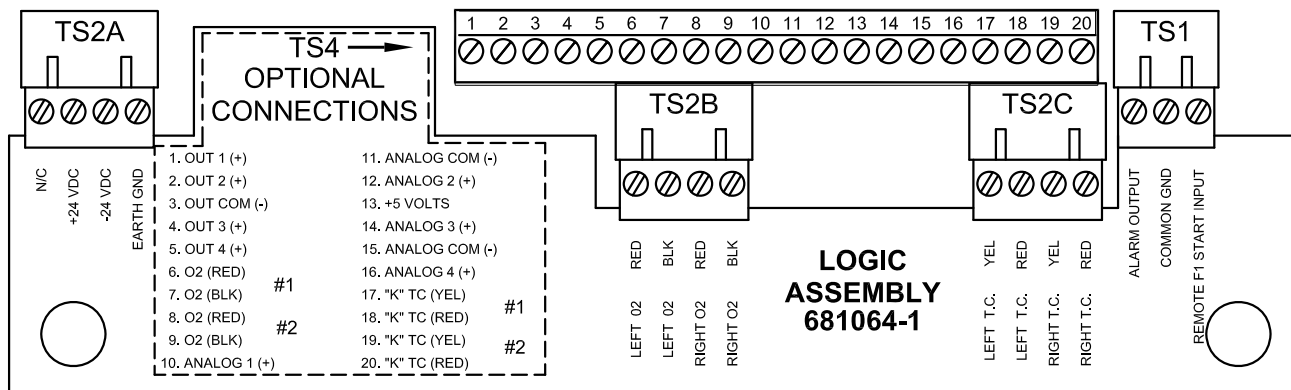

TS4:

PIN 1	OUT1 (+)	RUN L or R Exhaust >650°F (closed to ground when hot)
PIN 2	OUT2 (+)	PSD Protection ShutDown (closed to ground when safe)
PIN 3	OUT COMMON (-)	Common for all Outputs (not isolated)
PIN 4	OUT3 (+)	CSD Compliance ShutDown (closed to ground when safe)
PIN 5	OUT4 (+)	AUTO-OK (closed to ground when auto)
PIN 6	O2 (RED) #1	Optional O2 Sensor (0-1.6vdc) Catalyst Input
PIN 7	O2 (BLK) #1	Optional O2 Sensor (0-1.6vdc) Catalyst Input
PIN 8	O2 (RED) #2	Optional O2 Sensor (0-1.6vdc) Catalyst Output
PIN 9	O2 (BLK) #2	Optional O2 Sensor (0-1.6vdc) Catalyst Output
PIN 10	ANALOG 1 (+)	Multipurpose Analog Input Signal (0-5vdc)
PIN 11	ANALOG COM (-)	Common for Analog 1 and 2
PIN 12	ANALOG 2 (+)	Multipurpose Analog Input Signal (0-5vdc)
PIN 13	+5 VOLTS	Suitable for powering 5 volt analog sensors (200ma PTC)
PIN 14	ANALOG 3 (+)	Multipurpose Analog Input Signal (0-5vdc)
PIN 15	ANALOG COM (-)	Common for Analog 3 and 4
PIN 16	ANALOG 4 (+)	Multipurpose Analog Input Signal (0-5vdc)
PIN 17	"K" TC (YEL) #1	Optional Temperature Input Catalyst Input
PIN 18	"K" TC (RED) #1	Optional Temperature Input Catalyst Input
PIN 19	"K" TC (YEL) #2	Optional Temperature Input Catalyst Output
PIN 20	"K" TC (RED) #2	Optional Temperature Input Catalyst Output

FIG. 8 TYPICAL O₂ SENSOR RESPONSE (ESTIMATED DATA)

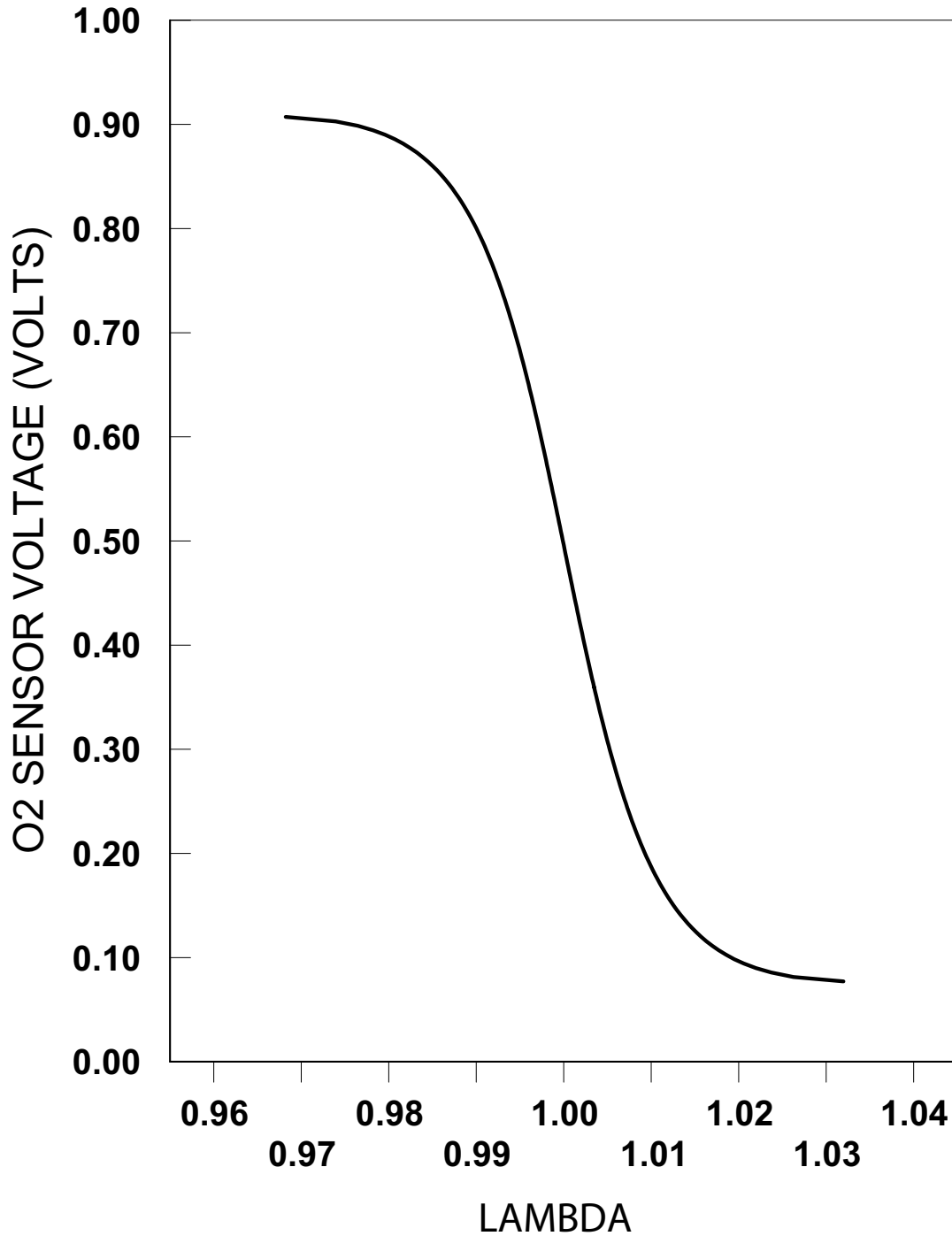

EPC-100E AIR-FUEL CONTROLLER

FIG. 9 PARTS BREAKDOWN

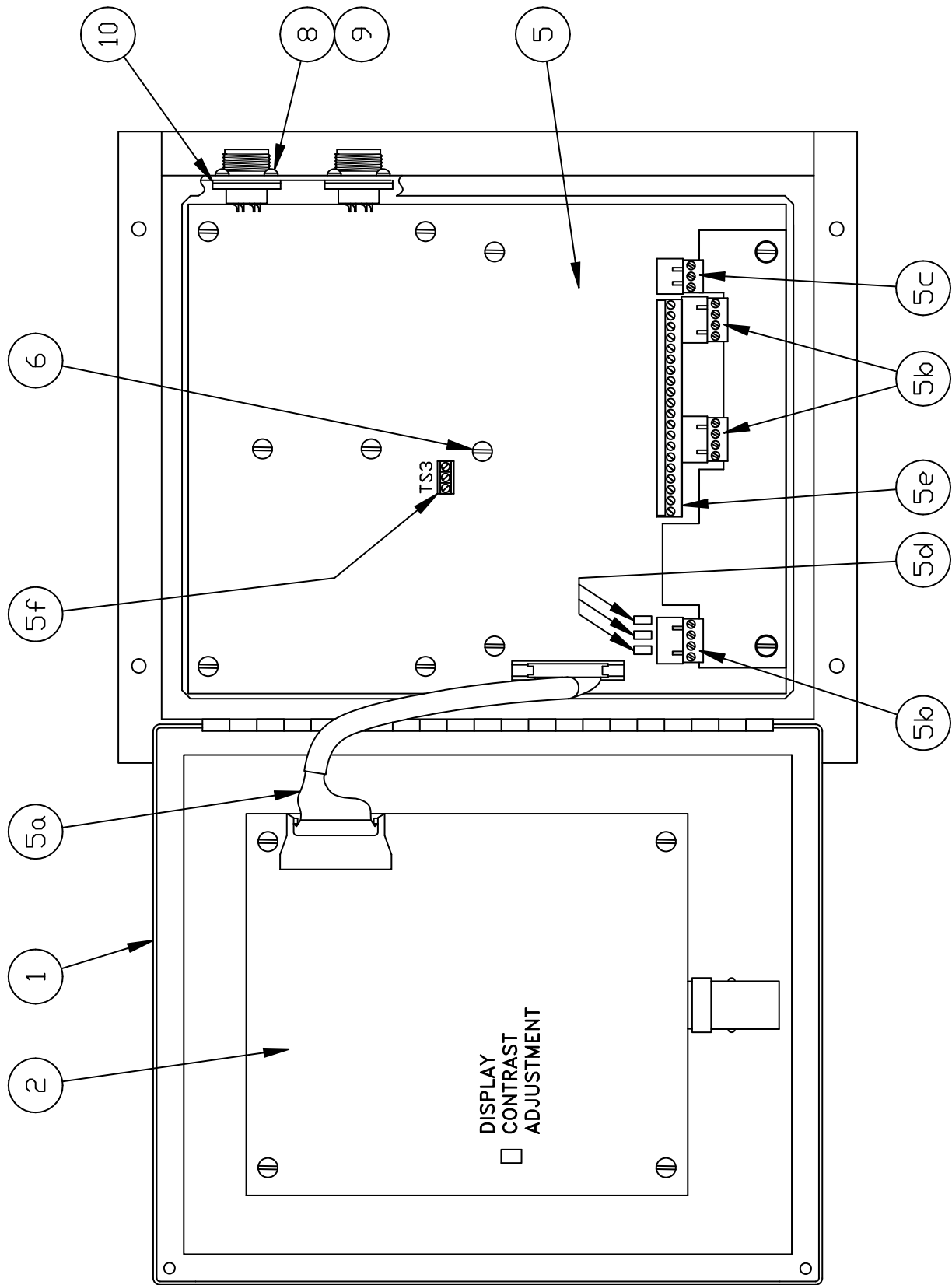

FIG. 10 EPC-100E PARTS IDENTIFICATION

Replacement parts are available from authorized Altronic distributors.

REF. NO.	QTY.	PART NO.	DESCRIPTION
1	1	670040-1	Enclosure/keypad assembly
2	1	672124	Display board assembly
5	1	681064-1	Control/stepper board assembly
5a	1	610583	Cable assembly, display board
5b	3	604137	Terminal block - 4 position
5c	1	604149	Terminal block - 3 position
5d	3	601653	Fuse, control board
5e	1	610243	Terminal block - 20 position
5f	1	610241	Terminal block - 3 position
6	15	902439	Screw 10-32 x 3/8"
8	8	902064	Screw 6-32
10	2	501335	Gasket, connector

NOTE: New board assembly 681064-1 replaces prior control board 681051 and stepper board assembly 681052.

FIG. 11 EPC-100E ACCESSORY KIT IDENTIFICATION

Contents of Accessory Kit 691310-1:

REF. NO.	QTY.	PART NO.	DESCRIPTION
1	1	693005-1	Cable Assembly, Control Valve, 25 ft.
2	1	693006-1	Cable Assembly, Oxygen Sensor, 25 ft.
3	1	610621	Oxygen Sensor

Contents of Accessory Kit 691310-2:

REF. NO.	QTY.	PART NO.	DESCRIPTION
1	1	693005-2	Cable Assembly, Control Valve, 50 ft.
2	1	693006-2	Cable Assembly, Oxygen Sensor, 50 ft.
3	1	610621	Oxygen Sensor