

0. Table of contents and alphanumeric listing	0
1. Screw clamp	1 - 37
2. Spring clamp	38 - 54
3. ADO - Screw clamp	55 - 67
4. ADO - ADO	68 - 82
5. Power terminal blocks	83 - 86
6. Quick-connect terminal blocks	87 - 88
7. Railway applications	89 - 99
8. Pluggable terminal blocks	100 - 102
9. Accessories	103 - 105
10. Marking	106 - 108



1 - Screw clamp



Feed through and ground terminal blocks	1 - 8
Power terminal blocks	9
Feed through terminal blocks	
Double deck	10
Triple deck	11
Three level sensor	
Terminal blocks without ground connection	12
Terminal blocks with ground connection	13
Terminal blocks for distribution boxes	14
Double deck + protection terminal blocks for distribution boxes	15
Interruptible terminal blocks for neutral circuit	16 - 17
Distribution: phase, ground terminal blocks	18 - 20
Distribution blocks	
Type BRU Single pole	21
Type BRU Three pole	22
Type BRU Single pole	23
Type BRT Three pole	24
Type BRU Four pole	25

Heavy duty switch terminal blocks with blade	26 - 27
Heavy duty switch terminal blocks	28
Heavy duty switch and fuse holder terminal blocks	29
Fuse holder terminal blocks	30
Fuse holder terminal blocks & heavy duty switch terminal block	
with contact control pull lever	31
Terminal blocks for test circuits with sliding bridge	32
Terminal blocks for metering circuits	33
ESSAILEC terminal blocks	34
Safety connection terminal blocks	35
Miniblocks	36 - 37

2 - Spring clamp

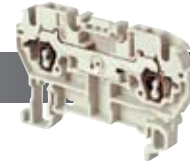

Angled terminal blocks	38
Feed through and ground terminal blocks	39
Feed through and ground terminal blocks	40
Feed through terminal blocks	41
Feed through and ground terminal blocks	42 - 43
Feed through terminal blocks for sensors/actuators	44
Terminal blocks for distribution boxes	45
Switch for neutral conductor	46 - 47
Heavy duty switch, terminal blocks with blade	48
Fuse holder terminal blocks	49
Miniblocks	
Base mount (snap-in or brackets)	50
Feed through	51 - 52
Base mount with snap-in mounting foot	53
Base mount with flanges	54

3 - ADO - Screw clamp



Feed through and ground terminal blocks	55 - 58
Feed through and ground terminal blocks - double deck	59
Heavy duty switch terminal blocks with blade	60
Fuse holder terminal blocks	61 - 62
Miniblocks	
Feed through	63 - 65
Base mount with snap-in mounting foot	66
Base mount with flanges	67

4 - ADO - ADO

Feed through and ground terminal blocks	68 - 71
Feed through terminal blocks-double deck.....	72
Insulation displacement for sensors / actuators	73
Heavy duty switch terminal blocks with blade	74
Fuse holder terminal blocks for fuses.....	75 - 76
Miniblocks	
Feed through	77 - 78
Feed through and ground	79
Base mount with snap-in mounting foot.....	80
Base mount with flanges.....	81
Accessories	82



5 - Power terminal blocks

With bistable foot and base mounting	83 - 86
--------------------------------------------	---------



6 - Quick-connect terminal blocks

Feed through terminal blocks	87
Quick-connect terminal blocks.....	88



7 - Terminal blocks for railway applications

Terminal blocks with longitudinal quick connect tabs	89
Terminal blocks with vertical and longitudinal quick connect tabs	90
Component holders with tabs	91
Terminal blocks with 1 stud terminal.....	92 - 94
Terminal blocks with 2 stud terminals	95 - 96
Terminal blocks with insulation displacement	97 - 98
Heavy duty switch terminal blocks with blade and plug.....	99



8 - Pluggable terminal blocks

Pluggable terminal blocks.....	100
Pluggable switch terminal blocks.....	101
Female plugs.....	102

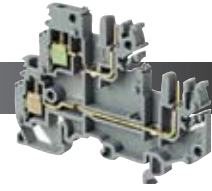

9 - Accessories

End stops, mounting rails, test devices, shield connectors	
Shield terminals for collector bar	103
DIN rail cutters.....	104
Rail mounted receptacle.....	105



0

10 - Marking

Marking for terminal blocks.....	106 - 107
Marking table.....	108
Accessories.....	108



0007 865.26 – 0174 601.01



Part No.	Page No.	Part No.	Page No.	Part No.	Page No.	Part No.	Page No.	Part No.	Page No.	Part No.	Page No.	Part No.	Page No.
0007 865.26	102	0105 031.14	2	0114 836.00	31	0115 720.20	101	0118 499.23	10	0163 313.24	65	0168 458.13	90
0007 865.26	103	0105 032.15	2	0114 836.00	59	0115 770.02	101	0118 618.01	6	0163 313.24	66	0168 459.14	89
0094 302.21	102	0105 044.21	10	0114 836.00	59	0115 930.13	35	0118 707.03	1	0163 313.24	67	0168 459.14	90
0094 303.22	102	0105 045.22	10	0114 836.00	72	0115 957.12	100	0118 707.03	1	0163 315.26	33	0168 460.11	90
0094 304.23	102	0105 046.23	10	0114 836.00	103	0115 959.24	100	0118 707.03	2	0163 468.00	92	0168 461.06	90
0094 305.24	102	0105 047.24	10	0114 994.07	27	0115 961.16	100	0118 707.03	2	0163 468.00	95	0168 462.07	90
0094 306.25	102	0105 048.05	10	0114 994.07	27	0115 962.17	100	0118 707.03	4	0163 475.27	93	0168 463.00	90
0094 307.26	102	0105 049.06	10	0115 116.07	2	0115 964.11	100	0118 707.03	4	0163 476.20	93	0168 481.23	89
0094 308.07	102	0105 051.20	2	0115 118.11	4	0115 966.13	101	0118 707.03	5	0163 476.20	94	0168 481.23	89
0094 309.00	102	0105 052.21	1	0115 120.17	5	0115 971.10	32	0118 707.03	5	0163 479.03	94	0168 482.24	89
0094 310.24	102	0105 075.20	1	0115 124.07	7	0115 986.00	27	0118 707.03	6	0163 503.24	92	0168 482.24	89
0094 311.11	102	0105 077.22	1	0115 129.14	6	0115 987.01	27	0118 707.03	26	0163 503.24	95	0168 483.25	89
0094 312.12	102	0105 116.16	2	0115 189.11	87	0116 538.17	64	0118 707.03	100	0163 860.05	16	0168 483.25	89
0094 313.13	102	0105 118.20	4	0115 191.03	88	0116 538.17	65	0120 251.07	37	0163 860.05	17	0168 484.26	89
0094 314.14	102	0105 120.26	5	0115 216.13	8	0116 538.17	66	0120 491.11	37	0164 406.24	16	0168 484.26	89
0094 315.15	102	0105 124.16	7	0115 236.17	32	0116 538.17	67	0123 027.01	87	0164 406.24	17	0168 485.27	89
0094 352.22	102	0105 128.22	4	0115 237.10	32	0116 539.10	64	0125 116.01	2	0164 519.24	103	0168 485.27	89
0094 353.23	102	0105 129.23	6	0115 239.22	32	0116 539.10	65	0125 117.02	16	0164 585.17	35	0168 500.12	103
0094 354.24	102	0105 135.11	30	0115 271.22	10	0116 539.10	66	0125 118.13	4	0164 586.10	35	0168 520.05	29
0094 355.25	102	0105 209.14	2	0115 277.20	28	0116 539.10	67	0125 119.14	16	0164 587.11	35	0168 521.22	29
0094 356.26	102	0105 486.12	1	0115 279.02	87	0116 540.25	64	0125 120.11	5	0164 588.22	35	0168 522.23	29
0094 357.27	102	0107 005.25	2	0115 280.20	88	0116 540.25	65	0125 121.06	17	0165 111.14	7	0168 528.24	29
0094 358.00	102	0107 005.25	4	0115 313.14	33	0116 540.25	66	0125 124.01	7	0165 113.16	2	0168 700.22	103
0094 359.01	102	0107 005.25	5	0115 320.27	35	0116 540.25	67	0125 129.16	6	0165 114.17	4	0168 949.17	89
0094 360.06	102	0110 106.25	36	0115 328.23	20	0116 576.15	3	0125 189.13	87	0165 115.10	5	0168 956.06	16
0094 361.23	102	0110 251.05	37	0115 329.24	20	0116 591.05	29	0125 216.15	8	0165 275.00	2	0168 956.06	17
0094 362.24	102	0110 264.02	15	0115 330.21	20	0116 629.22	3	0125 358.03	17	0165 343.04	20	0168 974.00	29
0094 363.25	102	0110 269.17	15	0115 331.16	20	0116 656.25	10	0125 468.22	3	0165 344.05	20	0173 016.10	36
0094 364.26	102	0110 327.21	15	0115 332.17	20	0116 657.26	10	0125 479.25	3	0165 345.06	20	0173 016.10	37
0094 365.27	102	0110 328.02	15	0115 333.10	20	0116 702.24	101	0125 486.05	1	0165 346.07	20	0173 016.10	37
0101 508.04	103	0110 331.25	15	0115 334.11	20	0116 771.20	12	0125 487.06	16	0165 347.00	20	0173 181.13	33
0101 513.10	103	0110 439.22	14	0115 359.02	32	0116 771.20	12	0125 490.15	10	0165 348.11	20	0173 217.26	11
0101 514.11	103	0110 440.07	14	0115 406.13	18	0116 771.20	13	0125 556.12	8	0165 349.12	20	0173 217.26	14
0101 515.12	103	0110 441.24	14	0115 407.14	18	0116 771.20	13	0125 593.00	17	0165 420.26	18	0173 217.26	15
0101 517.14	103	0110 442.25	14	0115 408.25	18	0116 781.13	33	0125 711.15	100	0165 421.13	18	0173 217.26	37
0101 673.00	103	0110 447.22	14	0115 409.26	18	0116 783.15	33	0125 930.15	35	0165 422.14	18	0173 218.07	11
0103 061.20	7	0110 491.17	37	0115 410.12	18	0116 900.27	8	0125 960.23	100	0165 423.15	18	0173 218.07	14
0103 062.21	1	0112 086.02	36	0115 411.07	18	0116 900.27	8	0125 961.10	100	0165 424.16	18	0173 218.07	15
0103 062.21	1	0113 027.07	87	0115 412.00	18	0116 900.27	9	0126 576.17	3	0165 425.17	18	0173 218.07	37
0103 062.21	2	0113 027.07	88	0115 413.01	19	0116 900.27	10	0126 629.24	3	0165 426.10	18	0173 219.00	11
0103 062.21	2	0113 065.15	8	0115 414.02	19	0116 900.27	11	0127 600.05	37	0165 427.11	19	0173 219.00	14
0103 062.21	4	0113 075.17	87	0115 415.03	19	0116 900.27	29	0128 035.16	16	0165 428.22	19	0173 219.00	15
0103 062.21	4	0113 075.17	88	0115 416.04	19	0116 900.27	29	0128 035.16	17	0165 429.23	19	0173 219.00	37
0103 062.21	5	0113 101.17	7	0115 417.05	19	0116 900.27	31	0128 233.21	7	0165 430.20	19	0173 220.05	103
0103 065.24	6	0113 137.02	28	0115 418.16	19	0116 900.27	59	0128 368.10	1	0165 431.15	19	0173 221.22	11
0103 125.15	1	0113 373.26	28	0115 419.17	19	0116 900.27	59	0128 368.10	2	0165 432.16	19	0173 221.22	14
0103 125.15	2	0113 629.27	32	0115 468.20	3	0116 900.27	72	0128 368.10	4	0165 433.17	19	0173 221.22	15
0103 125.15	4	0113 851.16	8	0115 479.23	3	0116 900.27	83	0128 368.10	5	0165 453.23	6	0173 221.22	37
0103 125.15	5	0114 117.07	14	0115 486.03	1	0116 900.27	83	0128 368.10	16	0165 454.24	7	0173 226.27	11
0103 126.16	1	0114 117.07	15	0115 490.13	10	0116 900.27	84	0128 368.10	17	0165 488.27	1	0173 226.27	14
0103 126.16	2	0114 144.12	87	0115 501.12	10	0116 900.27	85	0128 499.25	10	0165 556.22	8	0173 226.27	15
0103 126.16	4	0114 144.12	88	0115 505.16	26	0116 900.27	85	0128 618.03	6	0165 596.13	8	0173 226.27	37
0103 126.16	5	0114 205.20	33	0115 510.16	36	0116 900.27	86	0160 487.25	89	0165 677.03	1	0173 438.24	96
0103 126.16	26	0114 328.22	33	0115 529.15	28	0116 900.27	86	0160 496.26	37	0165 809.01	2	0173 439.25	96
0103 189.26	14	0114 329.23	33	0115 537.05	12	0116 900.27	103	0160 563.00	90	0165 830.21	4	0173 441.27	96
0103 189.26	15	0114 434.05	35	0115 538.16	12	0116 913.07	29	0160 564.01	90	0165 909.05	1	0173 449.07	96
0103 230.02	28	0114 778.05	32	0115 539.17	33	0116 951.15	30	0160 606.14	89	0167 860.01	103	0173 451.21	96
0103 312.20	2	0114 825.05	28	0115 542.12	12	0116 964.12	14	0160 619.10	90	0168 273.11	35	0173 452.22	96
0103 312.20	4	0114 836.00	8	0115 556.10	8	0116 979.21	32	0160 621.02	90	0168 353.11	89	0173 453.23	96
0103 312.20	5	0114 836.00	8	0115 561.15	29	0116 987.02	35	0162 309.10	91	0168 356.14	89	0173 454.24	96
0103 862.20	3	0114 836.00	9	0115 604.21	29	0117 318.23	36	0162 972.20	91	0168 356.14	90	0173 460.06	96
0103 863.21	3	0114 836.00	10	0115 642.26	13	0117 600.03	37	0162 979.07	96	0168 357.15	90	0173 461.23	96
0103 881.14	8	0114 836.00	12	0115 643.27	13	0118 233.27	7	0162 988.21	91	0168 366.16	100	0173 530.24	10
0103 923.15	30	0114 836.00	12	0115 657.25	30	0118 368.16	1	0162 991.14	96	0168 367.17	100	0173 530.24	103
0103 975.21	37	0114 836.00	13	0115 659.07	30	0118 368.16	2	0162 993.16	91	0168 401.03	32	0173 906.22	33
0105 001.27	2	0114 836.00	13	0115 662.22	30	0118 368.16	4	0163 043.21	103	0168 456.01	89	0173 907.23	33
0105 002.20	2	0114 836.00	14	0115 685.12	35	0118 368.16	5	0163 070.00	103	0168 456.01	90	0173 908.04	33
0105 004.22	4	0114 836.00	15	0115 688.25	28	0118 368.16	26	0163 262.01	103	0168 457.02	89	0174 300.17	103
0105 011.10	33	0114 836.00	29	0115 699.20	26	0118 368.16	100	0163 311.22	33	0168 457.02	90	0174 558.05	33
0105 012.11	33	0114 836.00	29	0115 700.05	26	0118 495.17	10	0163 313.24	64	0168 458.13	89	0174 601.01	33

0

Part No.	Page No.	Part No.	Page No.	Part No.	Page No.	Part No.	Page No.	Part No.	Page No.	Part No.	Page No.	Part No.	Page No.
0174 788.04	32	0176 667.04	2	0178 024.25	12	0179 650.22	23	0196 896.00	97	0199 148.04	70	0199 343.07	68
0174 789.05	32	0176 667.04	3	0178 024.25	13	0179 657.15	22	0196 896.00	97	0199 148.04	70	0199 343.07	68
0176 278.16	1	0176 667.04	3	0178 024.25	13	0179 668.20	10	0196 896.00	98	0199 184.11	76	0199 343.07	69
0176 278.16	55	0176 667.04	35	0178 025.26	12	0179 668.20	29	0196 987.03	35	0199 185.12	76	0199 343.07	69
0176 278.16	68	0176 667.04	56	0178 025.26	12	0179 669.21	10	0197 312.16	91	0199 186.13	76	0199 343.07	70
0176 278.16	100	0176 667.04	59	0178 025.26	13	0179 669.21	29	0198 233.20	7	0199 187.14	76	0199 343.07	70
0176 279.17	1	0176 667.04	69	0178 025.26	13	0179 670.26	10	0198 352.07	89	0199 188.25	76	0199 343.07	71
0176 279.17	55	0176 667.04	72	0178 026.27	12	0179 670.26	29	0198 368.17	2	0199 208.11	75	0199 343.07	71
0176 279.17	68	0176 667.04	87	0178 026.27	12	0179 671.13	10	0198 368.17	4	0199 209.12	75	0199 352.00	60
0176 279.17	100	0176 667.04	87	0178 026.27	13	0179 671.13	29	0198 368.17	5	0199 210.06	75	0199 354.02	74
0176 280.05	1	0176 667.04	88	0178 026.27	13	0179 672.14	10	0198 549.05	91	0199 211.23	75	0199 355.03	74
0176 280.05	55	0176 667.04	88	0178 027.20	12	0179 672.14	29	0198 618.02	6	0199 212.24	75	0199 382.27	75
0176 280.05	68	0176 669.16	4	0178 027.20	12	0179 879.14	101	0198 692.25	89	0199 231.27	74	0199 382.27	76
0176 280.05	100	0176 669.16	10	0178 027.20	13	0179 880.02	101	0198 692.25	90	0199 232.20	74	0199 393.22	96
0176 281.22	1	0176 669.16	35	0178 027.20	13	0179 892.22	25	0198 729.01	91	0199 242.02	59	0199 394.23	96
0176 281.22	55	0176 669.16	57	0178 032.25	12	0183 436.05	33	0198 729.01	96	0199 243.03	59	0199 400.06	90
0176 281.22	68	0176 669.16	58	0178 032.25	12	0187 312.14	91	0198 729.01	96	0199 262.06	59	0199 411.14	91
0176 281.22	100	0176 669.16	59	0178 032.25	13	0190 001.20	83	0199 002.26	2	0199 262.06	59	0199 411.14	93
0176 282.23	1	0176 669.16	70	0178 032.25	13	0190 002.21	83	0199 003.27	4	0199 275.03	65	0199 411.14	94
0176 282.23	55	0176 669.16	71	0178 072.05	102	0190 003.22	84	0199 004.20	5	0199 276.04	65	0199 412.15	91
0176 282.23	68	0176 670.13	4	0178 408.14	29	0190 004.23	84	0199 005.21	6	0199 277.05	65	0199 412.15	93
0176 282.23	100	0176 670.13	10	0178 408.14	29	0190 005.24	84	0199 006.22	7	0199 279.17	65	0199 412.15	94
0176 663.00	2	0176 670.13	35	0178 408.14	31	0190 006.25	85	0199 034.15	56	0199 280.05	65	0199 417.12	59
0176 663.00	3	0176 670.13	57	0178 408.14	59	0190 007.26	85	0199 035.16	56	0199 281.22	65	0199 417.12	59
0176 663.00	3	0176 670.13	58	0178 408.14	72	0190 008.07	86	0199 036.17	56	0199 283.24	79	0199 420.21	36
0176 663.00	35	0176 670.13	59	0178 408.14	103	0190 009.00	86	0199 037.10	56	0199 284.25	79	0199 420.21	36
0176 663.00	56	0176 670.13	70	0178 646.11	82	0190 016.16	83	0199 039.22	56	0199 285.26	79	0199 420.21	37
0176 663.00	59	0176 670.13	71	0178 745.14	1	0190 016.16	85	0199 040.07	56	0199 287.20	79	0199 420.21	37
0176 663.00	69	0176 671.00	4	0178 745.14	2	0190 017.17	83	0199 042.25	57	0199 288.01	79	0199 420.21	52
0176 663.00	72	0176 671.00	10	0178 745.14	18	0190 017.17	85	0199 043.26	57	0199 289.02	79	0199 420.21	65
0176 663.00	87	0176 671.00	35	0178 745.14	26	0190 018.20	84	0199 044.27	57	0199 302.07	2	0199 420.21	79
0176 663.00	87	0176 671.00	57	0178 745.14	27	0190 018.20	86	0199 045.20	57	0199 302.07	4	0199 420.21	103
0176 663.00	88	0176 671.00	58	0178 745.14	27	0190 019.21	84	0199 050.01	56	0199 302.07	5	0199 421.16	64
0176 663.00	88	0176 671.00	59	0178 745.14	33	0190 019.21	86	0199 051.26	69	0199 303.00	6	0199 421.16	64
0176 664.01	2	0176 671.00	70	0178 745.14	55	0190 033.17	83	0199 052.27	69	0199 304.01	7	0199 421.16	65
0176 664.01	3	0176 671.00	71	0178 745.14	56	0190 034.10	83	0199 053.20	69	0199 305.02	1	0199 421.16	66
0176 664.01	3	0176 672.01	4	0178 745.14	68	0190 035.11	84	0199 054.21	69	0199 305.02	2	0199 421.16	66
0176 664.01	35	0176 672.01	10	0178 745.14	69	0190 036.12	84	0199 056.23	69	0199 305.02	2	0199 421.16	66
0176 664.01	56	0176 672.01	35	0178 745.14	87	0190 037.13	84	0199 059.06	70	0199 305.02	4	0199 422.17	64
0176 664.01	59	0176 672.01	57	0178 745.14	88	0190 316.27	89	0199 060.03	70	0199 305.02	4	0199 422.17	64
0176 664.01	69	0176 672.01	58	0178 745.14	97	0193 027.00	87	0199 061.20	70	0199 305.02	5	0199 422.17	65
0176 664.01	72	0176 672.01	59	0178 745.14	103	0193 027.00	88	0199 062.21	70	0199 320.04	102	0199 422.17	66
0176 664.01	87	0176 672.01	70	0178 745.14	103	0193 065.16	8	0199 069.00	56	0199 336.20	55	0199 422.17	66
0176 664.01	87	0176 672.01	71	0178 746.15	1	0193 075.10	88	0199 070.05	56	0199 336.20	55	0199 422.17	66
0176 664.01	88	0176 673.02	4	0178 746.15	2	0193 878.22	90	0199 071.22	56	0199 336.20	56	0199 423.10	78
0176 664.01	88	0176 673.02	10	0178 746.15	18	0194 329.24	33	0199 072.23	57	0199 336.20	56	0199 423.10	78
0176 665.02	2	0176 673.02	35	0178 746.15	26	0194 836.01	103	0199 073.24	57	0199 336.20	57	0199 423.10	79
0176 665.02	3	0176 673.02	57	0178 746.15	27	0195 111.03	7	0199 075.26	57	0199 336.20	57	0199 423.10	80
0176 665.02	3	0176 673.02	58	0178 746.15	27	0195 115.07	5	0199 076.27	57	0199 336.20	58	0199 423.10	80
0176 665.02	35	0176 673.02	59	0178 746.15	33	0195 116.00	2	0199 077.20	57	0199 336.20	58	0199 424.11	78
0176 665.02	56	0176 673.02	70	0178 746.15	55	0195 118.12	4	0199 080.20	69	0199 338.02	55	0199 424.11	78
0176 665.02	59	0176 673.02	71	0178 746.15	56	0195 120.10	5	0199 081.15	69	0199 338.02	56	0199 424.11	79
0176 665.02	69	0176 675.04	5	0178 746.15	68	0195 124.00	7	0199 082.16	69	0199 338.02	57	0199 424.11	80
0176 665.02	72	0176 676.05	5	0178 746.15	69	0195 129.15	6	0199 083.17	69	0199 338.02	58	0199 424.11	80
0176 665.02	87	0176 677.06	5	0178 746.15	87	0195 189.12	87	0199 087.13	70	0199 339.03	55	0199 437.16	67
0176 665.02	87	0176 678.17	5	0178 746.15	88	0195 191.04	88	0199 088.24	70	0199 339.03	55	0199 437.16	67
0176 665.02	88	0176 679.10	5	0178 746.15	97	0195 216.14	8	0199 089.25	70	0199 339.03	56	0199 438.27	67
0176 665.02	88	0176 704.02	36	0178 944.04	82	0178 944.04	10	0199 091.17	70	0199 339.03	56	0199 438.27	67
0176 666.03	2	0176 705.03	36	0179 466.06	82	0195 359.03	32	0199 092.10	70	0199 339.03	57	0199 439.20	81
0176 666.03	3	0176 706.04	36	0179 534.22	25	0195 468.21	3	0199 095.13	31	0199 339.03	57	0199 439.20	81
0176 666.03	3	0176 707.05	36	0179 535.23	25	0195 479.24	3	0199 098.26	69	0199 339.03	58	0199 440.05	81
0176 666.03	35	0176 708.16	36	0179 626.06	6	0195 486.04	1	0199 107.24	60	0199 339.03	58	0199 440.05	81
0176 666.03	56	0176 736.21	10	0179 628.10	6	0195 490.14	10	0199 108.05	60	0199 341.05	68	0199 443.24	1
0176 666.03	59	0176 737.22	10	0179 629.11	6	0195 501.13	10	0199 118.26	57	0199 341.05	68	0199 443.24	55
0176 666.03	69	0176 738.03	10	0179 630.16	6	0195 556.11	8	0199 135.17	33	0199 341.05	69	0199 443.24	68
0176 666.03	72	0176 739.04	10	0179 631.03	6	0195 604.22	29	0199 136.10	33	0199 341.05	69	0199 444.25	31
0176 666.03	87	0176 740.11	10	0179 634.06	60	0195 639.24	32	0199 137.11	60	0199 341.05	70	0199 448.01	31
0176 666.03	87	0177 170.07	103	0179 634.06	103	0195 657.26	30	0199 138.22	60	0199 341.05	70	0199 476.25	72
0176 666.03	88	0177 849.04	100	0179 635.07	74	0195 659.00	30	0199 144.20	74	0199 341.05	71	0199 480.26	72
0176 666.03	88	0178 024.25	12	0179 635.07	103	0195 685.13	35	0199 145.21	74	0199 341.05	71	0199 481.13	72

0199 482.14 – 0291 105.26



Part No.	Page No.	Part No.	Page No.	Part No.	Page No.	Part No.	Page No.	Part No.	Page No.	Part No.	Page No.	Part No.	Page No.
0199 482.14	72	0205 963.03	74	0206 221.04	7	0230 031.24	107	0238 000.16	107	0290 201.11	52	0291 041.20	40
0199 554.23	55	0205 974.06	60	0206 277.14	82	0230 041.06	107	0238 002.04	107	0290 202.12	52	0291 041.20	48
0199 555.24	55	0205 974.06	64	0206 351.16	1	0230 042.07	107	0238 003.05	107	0290 203.13	52	0291 042.21	39
0199 556.25	55	0205 974.06	65	0206 351.16	2	0230 043.00	107	0238 004.06	107	0290 211.02	52	0291 042.21	40
0199 557.26	55	0205 974.06	66	0206 351.16	3	0230 044.01	107	0238 005.07	107	0290 212.03	52	0291 042.21	48
0199 558.07	55	0205 974.06	66	0206 351.16	3	0230 060.15	107	0238 006.00	107	0290 213.04	52	0291 051.22	40
0199 559.00	55	0205 974.06	67	0206 351.16	4	0230 131.25	107	0238 007.01	107	0290 219.12	52	0291 052.23	40
0199 560.05	55	0205 974.06	74	0206 351.16	5	0231 000.07	107	0238 008.12	107	0290 221.04	51	0291 061.24	39
0199 561.22	55	0205 974.06	78	0206 351.16	6	0231 002.25	107	0238 030.03	107	0290 222.05	51	0291 061.24	40
0199 563.24	68	0205 974.06	79	0206 351.16	7	0231 003.26	107	0238 031.20	107	0290 223.06	51	0291 061.24	41
0199 564.25	68	0205 974.06	80	0206 351.16	16	0231 004.27	107	0238 051.04	107	0290 231.06	51	0291 061.24	46
0199 565.26	68	0205 974.06	81	0206 351.16	17	0231 005.20	107	0238 052.05	107	0290 232.07	51	0291 061.24	48
0199 566.27	68	0205 974.06	97	0206 351.16	18	0231 006.21	107	0238 053.06	107	0290 233.00	51	0291 062.25	39
0199 567.20	68	0205 974.06	99	0206 351.16	19	0231 007.22	107	0238 054.07	107	0290 241.10	54	0291 062.25	40
0199 568.01	68	0205 975.07	60	0206 351.16	20	0231 008.03	107	0238 080.06	107	0290 242.11	54	0291 062.25	41
0199 569.02	68	0205 975.07	64	0206 351.16	21	0231 030.24	107	0290 011.25	40	0290 243.12	54	0291 062.25	46
0199 570.07	68	0205 975.07	65	0206 351.16	22	0231 031.11	107	0290 012.26	40	0290 250.25	52	0291 062.25	48
0199 591.11	74	0205 975.07	66	0206 351.16	22	0231 041.23	107	0290 013.27	40	0290 260.27	52	0291 077.24	38
0199 635.24	31	0205 975.07	66	0206 351.16	23	0231 042.24	107	0290 019.05	40	0290 261.14	53	0291 077.24	38
0199 870.04	32	0205 975.07	67	0206 351.16	24	0231 043.25	107	0290 020.02	40	0290 262.15	53	0291 077.24	40
0199 871.21	32	0205 975.07	74	0206 351.16	25	0231 044.26	107	0290 021.27	40	0290 263.16	53	0291 077.24	48
0199 872.22	32	0205 975.07	78	0206 351.16	26	0231 060.02	107	0290 022.20	40	0290 271.16	53	0291 077.24	103
0199 873.23	32	0205 975.07	79	0206 351.16	27	0231 131.12	107	0290 023.21	40	0290 272.17	53	0291 102.23	38
0199.003.27	4	0205 975.07	80	0206 351.16	27	0232 000.00	107	0290 024.22	40	0290 273.10	53	0291 102.23	40
0199.003.27	5	0205 975.07	81	0206 351.16	28	0232 002.26	107	0290 025.23	40	0290 281.01	54	0291 102.23	44
0205 170.14	103	0205 975.07	97	0206 351.16	28	0232 003.27	107	0290 026.24	40	0290 282.02	54	0291 102.23	44
0205 171.01	103	0205 975.07	99	0206 351.16	30	0232 004.20	107	0290 027.25	40	0290 291.03	42	0291 102.23	45
0205 172.02	103	0205 976.00	60	0206 351.16	31	0232 005.21	107	0290 028.06	40	0290 292.04	42	0291 102.23	46
0205 173.03	103	0205 976.00	64	0206 351.16	32	0232 006.22	107	0290 029.07	40	0290 293.05	42	0291 102.23	48
0205 175.05	103	0205 976.00	65	0206 351.16	33	0232 007.23	107	0290 030.04	40	0290 294.06	42	0291 102.23	48
0205 176.06	103	0205 976.00	66	0206 351.16	35	0232 008.04	107	0290 031.21	40	0290 296.00	42	0291 102.23	51
0205 177.07	103	0205 976.00	66	0206 351.16	87	0232 030.25	107	0290 032.22	40	0290 297.01	42	0291 102.23	52
0205 284.03	82	0205 976.00	67	0206 351.16	87	0232 031.12	107	0290 033.23	40	0290 299.13	42	0291 102.23	53
0205 392.07	92	0205 976.00	74	0206 351.16	88	0232 041.24	107	0290 034.24	40	0290 300.20	42	0291 102.23	54
0205 396.03	92	0205 976.00	78	0206 351.16	103	0232 042.25	107	0290 035.25	40	0290 311.06	38	0291 103.24	38
0205 424.27	92	0205 976.00	79	0206 389.15	100	0232 043.26	107	0290 036.26	40	0290 311.06	38	0291 103.24	40
0205 428.03	92	0205 976.00	80	0206 389.15	101	0232 044.27	107	0290 037.27	40	0290 314.01	38	0291 103.24	44
0205 429.04	92	0205 976.00	81	0206 391.07	100	0232 060.03	107	0290 039.01	40	0290 314.01	38	0291 103.24	44
0205 431.26	92	0205 976.00	97	0206 392.00	100	0232 131.13	107	0290 040.16	40	0290 322.01	45	0291 103.24	45
0205 710.11	82	0205 976.00	99	0206 404.05	2	0233 000.01	107	0290 041.03	48	0290 324.03	45	0291 103.24	46
0205 721.00	82	0205 977.01	60	0206 538.02	27	0233 002.27	107	0290 042.04	48	0290 326.05	45	0291 103.24	48
0205 735.06	36	0205 977.01	64	0206 635.16	88	0233 003.20	107	0290 045.07	46	0290 328.17	45	0291 103.24	48
0205 736.07	36	0205 977.01	65	0215 038.20	100	0233 004.21	107	0290 061.07	41	0290 330.15	45	0291 103.24	51
0205 737.00	36	0205 977.01	66	0215 038.20	101	0233 005.22	107	0290 062.00	41	0290 350.21	44	0291 103.24	52
0205 738.11	36	0205 977.01	66	0215 071.21	100	0233 006.23	107	0290 063.01	41	0290 354.11	44	0291 103.24	53
0205 772.13	83	0205 977.01	67	0215 580.21	36	0233 007.24	107	0290 064.02	41	0290 358.25	44	0291 103.24	54
0205 772.13	85	0205 977.01	74	0229 000.15	107	0229 008.05	107	0290 066.04	41	0290 360.23	44	0291 104.25	38
0205 773.14	83	0205 977.01	78	0229 002.03	107	0233 030.26	107	0290 067.05	41	0290 371.12	39	0291 104.25	40
0205 773.14	85	0205 977.01	79	0229 003.04	107	0233 031.13	107	0290 069.17	41	0290 372.13	39	0291 104.25	44
0205 774.15	83	0205 977.01	80	0229 004.05	107	0233 041.25	107	0290 070.14	41	0290 373.14	39	0291 104.25	44
0205 774.15	85	0205 977.01	81	0229 005.06	107	0233 042.26	107	0290 081.24	42	0290 379.22	39	0291 104.25	45
0205 775.16	83	0205 977.01	97	0229 006.07	107	0233 043.27	107	0290 082.25	42	0290 380.10	39	0291 104.25	46
0205 775.16	85	0205 977.01	99	0229 007.00	107	0233 044.20	107	0290 083.26	42	0290 381.05	39	0291 104.25	48
0205 776.17	84	0205 982.27	60	0229 008.11	107	0233 060.04	107	0290 084.27	42	0290 382.06	39	0291 104.25	48
0205 776.17	86	0205 982.27	64	0229 030.02	107	0233 131.14	107	0290 086.21	42	0290 383.07	39	0291 104.25	51
0205 777.10	84	0205 982.27	65	0229 031.27	107	0234 000.02	107	0290 087.22	42	0290 389.15	39	0291 104.25	52
0205 777.10	86	0205 982.27	66	0229 041.01	107	0234 002.20	107	0290 089.04	42	0290 390.12	39	0291 104.25	53
0205 778.21	84	0205 982.27	66	0229 042.02	107	0234 003.21	107	0290 090.01	42	0290 405.06	41	0291 104.25	54
0205 778.21	86	0205 982.27	67	0229 043.03	107	0234 004.22	107	0290 091.26	49	0290 406.07	41	0291 105.26	38
0205 779.22	84	0205 982.27	74	0229 044.04	107	0234 005.23	107	0290 092.27	49	0290 407.00	41	0291 105.26	40
0205 779.22	86	0205 982.27	78	0229 060.10	107	0234 006.24	107	0290 093.20	49	0290 408.11	41	0291 105.26	44
0205 955.03	60	0205 982.27	79	0230 000.12	107	0234 007.25	107	0290 094.21	49	0290 409.12	41	0291 105.26	44
0205 955.03	74	0205 982.27	80	0230 002.00	107	0234 008.06	107	0290 095.22	49	0290 410.06	41	0291 105.26	45
0205 956.04	60	0205 982.27	81	0230 003.01	107	0234 030.27	107	0290 097.24	49	0290 411.23	41	0291 105.26	46
0205 956.04	74	0205 982.27	97	0230 004.02	107	0234 031.14	107	0290 131.22	48	0290 412.24	41	0291 105.26	48
0205 957.05	60	0205 982.27	99	0230 005.03	107	0234 041.26	107	0290 132.23	48	0290 413.25	41	0291 105.26	48
0205 957.05	74	0206 217.00	7	0230 006.04	107	0234 042.27	107	0290 133.24	48	0290 414.26	41	0291 105.26	51
0205 958.16	60	0206 218.11	7	0230 007.05	107	0234 043.20	107	0290 134.25	48	0290 464.00	40	0291 105.26	52
0205 958.16	74	0206 219.12	7	0230 008.16	107	0234 044.21	107	0290 161.00	44	0290 465.01	40	0291 105.26	53
0205 963.03	60	0206 220.17	7	0230 030.07	107	0234 060.05	107	0290 163.02	44	0291 041.20	39	0291 105.26	54

0

Part No.	Page No.	Part No.	Page No.	Part No.	Page No.	Part No.	Page No.	Part No.	Page No.	Part No.	Page No.	Part No.	Page No.		
0291 110.26	38	0291 352.04	40	0299 507.01	67	0399 250.26	71	0399 765.16	62	0399 903.02	97	0400 186.21	4		
0291 110.26	40	0291 352.04	41	0299 509.13	67	0399 251.13	58	0399 767.10	62	0399 903.02	97	0400 187.22	4		
0291 110.26	44	0291 352.04	46	0299 510.07	67	0399 260.20	38	0399 769.22	62	0399 903.02	98	0400 188.04	5		
0291 110.26	44	0291 352.04	48	0299 511.24	67	0399 270.22	38	0399 777.12	61	0399 903.02	98	0400 189.03	5		
0291 110.26	45	0291 362.06	40	0299 513.26	81	0399 272.10	71	0399 778.23	61	0399 903.02	99	0400 190.01	5		
0291 110.26	46	0291 371.07	39	0299 514.27	81	0399 273.11	58	0399 780.12	61	0399 903.02	99	0400 191.26	6		
0291 110.26	48	0291 372.00	39	0299 515.20	81	0399 318.16	71	0399 781.07	61	0399 903.02	100	0400 192.27	6		
0291 110.26	48	0291 372.00	40	0299 517.22	81	0399 319.17	58	0399 785.03	61	0399 903.02	101	0400 193.20	6		
0291 110.26	51	0291 372.00	48	0299 518.03	81	0399 341.15	82	0399 786.04	61	0399 903.02	103	0400 194.21	7		
0291 110.26	52	0291 441.26	44	0299 519.04	81	0399 345.11	82	0399 800.17	58	0399 931.25	59	0400 195.22	7		
0291 110.26	53	0291 461.22	42	0299 521.26	66	0399 346.12	82	0399 801.04	71	0399 967.01	38	0400 196.23	7		
0291 110.26	54	0291 462.23	42	0299 521.26	66	0399 348.24	82	0399 802.05	97	0399 967.01	38	0400 219.11	38		
0291 122.16	42	0291 472.25	42	0299 522.27	66	0399 491.25	79	0399 802.05	97	0399 967.01	39	0400 220.16	38		
0291 122.16	47	0291 472.25	47	0299 522.27	66	0399 492.26	79	0399 802.05	98	0399 967.01	39	1SNA892461R1500	105		
0291 122.16	49	0291 474.27	42	0299 523.20	66	0399 493.27	79	0399 802.05	98	0399 967.01	40	XUS001735	103		
0291 122.16	49	0291 474.27	47	0299 523.20	66	0399 495.21	79	0399 804.07	99	0399 967.01	41	XUS001736	103		
0291 123.17	42	0291 476.21	42	0299 525.22	66	0399 563.04	43	0399 804.07	99	0399 967.01	42	XUS001737	103		
0291 123.17	47	0291 476.21	47	0299 526.23	66	0399 571.04	43	0399 903.02	38	0399 967.01	42	XUS001738	103		
0291 123.17	49	0291 478.03	42	0299 527.24	66	0399 572.05	43	0399 903.02	38	0399 967.01	43	XUS001772	104		
0291 123.17	49	0291 478.03	47	0299 529.06	80	0399 574.07	43	0399 903.02	39	0399 967.01	43	XUS002837	104		
0291 128.24	41	0291 559.04	45	0299 530.03	80	0399 575.00	36	0399 903.02	39	0399 967.01	44	XUSP01132	108		
0291 128.24	46	0291 560.01	45	0299 531.20	80	0299 531.20	80	0399 577.02	36	0399 903.02	40	0399 967.01	44	XUSP01548	108
0291 129.25	41	0291 642.06	39	0299 533.22	80	0399 581.27	43	0399 903.02	41	0399 967.01	45	XUSP01549	108		
0291 129.25	46	0291 642.06	39	0299 534.23	80	0299 534.23	80	0399 582.20	43	0399 903.02	42	0399 967.01	46	XUSP01551	108
0291 131.17	49	0291 694.24	41	0299 535.24	80	0399 583.21	43	0399 903.02	42	0399 967.01	46	XUSP01552	108		
0291 131.17	49	0291 695.25	41	0299 552.05	65	0399 584.22	43	0399 903.02	43	0399 967.01	47	XUSP02530	108		
0291 132.10	49	0291 696.26	41	0299 553.06	65	0399 586.24	46	0399 903.02	43	0399 967.01	47				
0291 132.10	49	0291 697.27	41	0299 554.07	79	0299 554.07	79	0399 587.25	46	0399 903.02	44	0399 967.01	48		
0291 144.24	42	0291 702.04	39	0299 555.00	79	0399 587.25	47	0399 903.02	44	0399 967.01	48				
0291 144.24	47	0295 391.20	92	0299 556.01	64	0399 587.25	47	0399 903.02	45	0399 967.01	49				
0291 144.24	49	0295 392.21	92	0299 557.02	64	0399 588.06	46	0399 903.02	46	0399 967.01	49				
0291 144.24	49	0295 393.22	95	0299 558.13	78	0299 558.13	78	0399 589.07	47	0399 903.02	46	0399 967.01	51		
0291 145.25	42	0295 394.23	92	0299 559.14	78	0399 590.04	47	0399 903.02	47	0399 967.01	51				
0291 145.25	47	0295 395.24	92	0299 632.05	65	0399 591.21	47	0399 903.02	47	0399 967.01	55				
0291 145.25	49	0295 396.25	92	0299 633.06	79	0299 633.06	79	0399 592.22	47	0399 903.02	48	0399 967.01	56		
0291 145.25	49	0295 397.26	95	0299 683.01	11	0399 600.26	59	0399 903.02	48	0399 967.01	57				
0291 161.25	42	0295 398.07	93	0299 684.02	11	0399 602.14	59	0399 903.02	49	0399 967.01	58				
0291 162.26	42	0295 399.00	93	0299 777.16	100	0399 617.02	43	0399 903.02	49	0399 967.01	60				
0291 194.17	41	0295 400.06	93	0299 777.16	101	0299 777.16	101	0399 618.13	43	0399 903.02	51	0399 967.01	61		
0291 194.17	46	0295 401.23	93	0356 200.21	22	0399 619.14	43	0399 903.02	51	0399 967.01	62				
0291 195.10	41	0295 402.24	93	0356 201.16	22	0399 620.11	43	0399 903.02	55	0399 967.01	64				
0291 195.10	46	0295 403.25	94	0356 202.17	22	0399 621.06	43	0399 903.02	56	0399 967.01	64				
0291 301.02	51	0295 405.27	94	0356 203.10	22	0399 677.16	73	0399 903.02	57	0399 967.01	68				
0291 301.02	51	0295 424.11	92	0356 204.11	21	0399 678.27	73	0399 903.02	58	0399 967.01	69				
0291 301.02	52	0295 424.11	93	0356 205.12	21	0399 679.20	73	0399 903.02	60	0399 967.01	70				
0291 301.02	52	0295 425.12	95	0356 206.13	21	0399 683.05	73	0399 903.02	61	0399 967.01	71				
0291 301.02	53	0295 426.13	92	0356 207.14	22	0399 684.06	73	0399 903.02	62	0399 967.01	73				
0291 301.02	53	0295 426.13	93	0356 208.25	21	0399 685.07	73	0399 903.02	64	0399 967.01	74				
0291 302.03	51	0295 428.25	92	0356 209.26	24	0399 686.00	73	0399 903.02	64	0399 967.01	75				
0291 302.03	51	0295 428.25	95	0356 210.21	24	0399 689.13	73	0399 903.02	68	0399 967.01	76				
0291 302.03	52	0295 429.26	92	0399 024.23	8	0399 692.06	73	0399 903.02	69	0399 967.01	78				
0291 302.03	52	0295 429.26	93	0399 030.05	55	0399 704.12	9	0399 903.02	70	0399 967.01	78				
0291 302.03	53	0295 430.23	95	0399 031.22	68	0399 705.13	9	0399 903.02	71	0399 967.01	97				
0291 302.03	53	0295 431.10	92	0399 066.05	38	0399 706.14	9	0399 903.02	73	0399 967.01	97				
0291 322.26	51	0295 431.10	95	0399 067.06	38	0399 707.15	73	0399 903.02	74	0399 967.01	98				
0291 322.26	52	0296 351.00	103	0399 068.17	38	0399 708.26	73	0399 903.02	75	0399 967.01	98				
0291 322.26	53	0299 489.07	64	0399 069.10	38	0399 709.27	73	0399 903.02	76	0399 967.01	99				
0291 323.27	51	0299 490.04	64	0399 070.05	38	0399 715.04	9	0399 903.02	78	0399 967.01	99				
0291 323.27	52	0299 491.21	64	0399 071.02	38	0399 716.05	9	0399 903.02	78	0399 967.01	100				
0291 323.27	53	0299 493.23	64	0399 072.03	38	0399 717.06	9	0399 903.02	89	0399 967.01	101				
0291 324.20	51	0299 494.24	64	0399 073.04	38	0399 730.17	97	0399 903.02	89	0399 967.01	103				
0291 324.20	52	0299 495.25	64	0399 176.00	8	0399 736.01	97	0399 903.02	90	0400 083.25	99				
0291 324.20	53	0299 497.27	78	0399 181.26	55	0399 748.25	98	0399 903.02	91	0400 178.10	43				
0291 325.21	51	0299 498.00	78	0399 184.21	68	0399 749.26	98	0399 903.02	92	0400 179.11	43				
0291 325.21	52	0299 499.01	78	0399 226.02	60	0399 752.11	99	0399 903.02	93	0400 180.07	43				
0291 325.21	53	0299 501.03	78	0399 227.03	60	0399 758.27	61	0399 903.02	94	0400 181.24	43				
0291 351.03	39	0299 502.04	78	0399 231.07	74	0399 758.27	62	0399 903.02	95	0400 182.22	43				
0291 351.03	40	0299 503.05	78	0399 232.00	74	0399 762.13	62	0399 903.02	95	0400 183.26	43				
0291 351.03	41	0299 505.07	67	0399 244.14	71	0399 763.14	62	0399 903.02	96	0400 184.27	1				
0291 352.04	39	0299 506.00	67	0399 245.15	58	0399 764.15	62	0399 903.02	96	0400 185.20	4				

Feed through and ground terminal blocks

Screw clamp, DIN 1-3

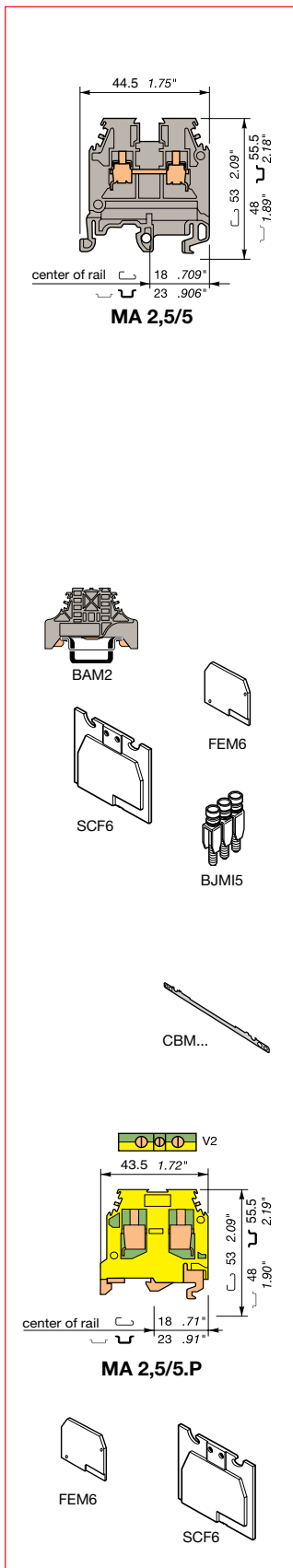

MA 2,5/5 - 2.5 mm² blocks - 5 mm .200" spacing

Characteristics

Wire size mm ² / AWG	Solid Stranded	IEC	UL	CSA
		NFC DIN		
		0.2 - 4	22-12 AWG	22-12 AWG
		0.22 - 2.5		
Voltage	V	800	600	600
Current	A	24	30	25
Short circuit current (MA 2,5/5.PI)	A / s	300A/1s		
Rated wire size	mm ² / AWG	2.5 mm ²	12 AWG	12 AWG
Wire stripping length	mm / inches	10 mm / .39"		
Recommended torque	Nm / lb.in	0.4-0.6 Nm / 3.5-5.3 lb.in		

Selection

Description	Type	Order P/N	Packaging
Standard block grey	<input type="checkbox"/> MA 2,5/5	0115 486.03	50
Standard block white	<input type="checkbox"/> MA 2,5/5	0105 052.21	50
Standard block blue	<input type="checkbox"/> MA 2,5/5.N	0125 486.05	50
Standard block yellow	<input type="checkbox"/> MA 2,5/5	0105 486.12	50
Standard block orange	<input type="checkbox"/> MA 2,5/5	0105 075.20	50
Standard block black	<input type="checkbox"/> MA 2,5/5	0105 077.22	50
Standard block red	<input type="checkbox"/> MA 2,5/5	0400 184.27	50
Standard block beige V0	<input type="checkbox"/> MA 2,5/5.V0	0195 486.04	50
Ground block yellow body/ green marking (without rail contact)	<input type="checkbox"/> MA 2,5/5.PI	0165 677.03	50

Accessories

End stop		BAM2 9.9 mm	0206 351.16	50
End section	grey	FEM6 2.8 mm	0118 368.16	20
	blue	FEM6 2.8 mm	0128 368.10	20
	orange	FEM6 2.8 mm	0103 126.16	20
	yellow	FEM6 2.8 mm	0103 062.21	20
	green	FEM6 2.8 mm	0103 125.15	20
Separator end section	grey <input type="checkbox"/>	SCF6 3 mm	0118 707.03	20
Assembled jumper bar (with IP20 protection)	2 poles	BJMI5 24 A	0176 278.16	10
	3 poles	BJMI5 24 A	0176 279.17	10
	4 poles	BJMI5 24 A	0176 280.05	10
	5 poles	BJMI5 24 A	0176 281.22	10
	10 poles	BJMI5 24 A	0176 282.23	10
Shield connector		CBM5 0.5 mm	0178 745.14	20
		CBM8 0.8 mm	0178 746.15	20

MA 2,5/5.P - 2.5 mm² ground block with rail contact - 5 mm .200" spacing

Characteristics

Wire size mm ² / AWG	Solid Stranded	IEC	UL	CSA
		NFC DIN		
		0.2 - 4	22-12 AWG	22-12 AWG
		0.22 - 2.5		
Short circuit current	A / s	300A/1s		
Rated wire size	mm ² / AWG	2.5 mm ²	12 AWG	12 AWG
Wire stripping length	mm / inches	10 mm / .39"		
Recommended torque	Nm / lb.in	0.4-0.6 Nm / 3.5-5.3 lb.in		

Selection

Description	Type	Order P/N	Packaging
Ground block V2 green/yellow	MA 2,5/5.P	0165 488.27	50
Mounting on DIN 3 rail without screw :			
Ground block V2 green/yellow	D 2,5/5.P	0165 909.05	50

Accessories

End section	yellow	FEM6 2.8 mm	0103 062.21	20
	yellow V0	FEM6 V0 2.8 mm	0199 305.02	20
Separator end section	grey <input type="checkbox"/>	SCF6 3 mm	0118 707.03	20

Other colors available. Please consult factory.

Feed through and ground terminal blocks

Screw clamp, 3 3 DIN 1-3

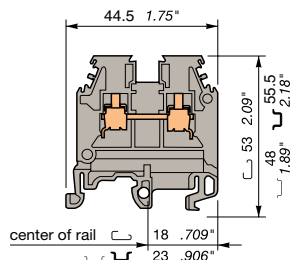

M 4/6

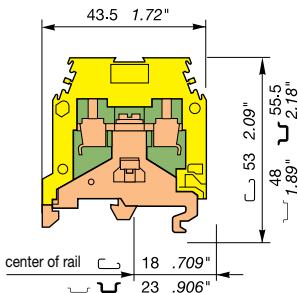
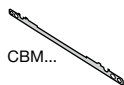
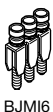
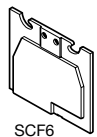
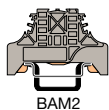

M 4/6.P

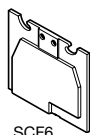
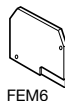

M 4/6 - 4 mm² blocks - 6 mm .238" spacing

Characteristics

Wire size mm ² / AWG	Solid Stranded	IEC	UL	CSA
		NFC VDE		
		0.2 - 4 mm ²	22-10 AWG	22-10 AWG
		0.22 - 4 mm ²		
Voltage	V	800	600	600
Current	A	32	30	25
Short circuit current (M 4/6.PI)	A / s	480A/1s		
Rated wire size	mm ² / AWG	4 mm ²	10 AWG	10 AWG
Wire stripping length	mm / inches	9.5 mm / .37"		
Recommended torque	Nm / lb.in	0.5-0.8 Nm / 4.4-7.1 lb.in		

Selection

Description	Type	Order P/N	Packaging
Standard block grey	□ M 4/6	0115 116.07	50
Standard block blue	■ M 4/6.N	0125 116.01	50
Standard block yellow	■ M 4/6	0105 116.16	50
Standard block orange	■ M 4/6	0105 002.20	50
Standard block red	■ M 4/6	0105 032.15	50
Standard block black	■ M 4/6	0105 031.14	50
Standard block beige V0	■ M 4/6 V0	0195 116.00	50
Standard block brown	■ M 4/6	0105 209.14	50
Standard block white	□ M 4/6	0105 051.20	50
Standard block green	■ M 4/6	0105 001.27	50
Standard block violet	■ M 4/6	0206 404.05	50
Standard block blue V0	■ M 4/6 V0	0199 002.26	50
Green block yellow body/ ground marking (without rail contact)	■ M 4/6.PI	0165 275.00	50

Accessories

End stop	BAM2	9.9 mm	0206 351.16	50	
End section	grey	□ FEM6	2.8 mm	0118 368.16	20
	blue	■ FEM6	2.8 mm	0128 368.10	20
	orange	■ FEM6	2.8 mm	0103 126.16	20
	yellow	■ FEM6	2.8 mm	0103 062.21	20
	green	■ FEM6	2.8 mm	0103 125.15	20
	white	□ FEM6	2.8 mm	0103 312.20	20
	beige V0	■ FEM6	2.8 mm	0198 368.17	20
	blue V0	■ FEM6	2.8 mm	0199 302.07	20
	yellow V0	■ FEM6	2.8 mm	0199 305.02	20
	black	■ FEM6	2.8 mm	0107 005.25	20
Separator end section	grey	□ SCF6	3 mm	0118 707.03	20
Assembled jumper bar	2 poles	BJM16	32 A	0176 663.00	10
(with IP20 protection)	3 poles	BJM16	32 A	0176 664.01	10
	4 poles	BJM16	32 A	0176 665.02	10
	5 poles	BJM16	32 A	0176 666.03	10
	10 poles	BJM16	32 A	0176 667.04	10
Shield connector		CBM5	0.5 mm	0178 745.14	20
		CBM8	0.6 mm	0178 746.15	20

M 4/6.P - 4 mm² ground block with rail contact - 6 mm .238" spacing

Characteristics

Wire size mm ² / AWG	Solid Stranded	IEC	UL	CSA
		NFC VDE		
		0.2 - 4 mm ²	22-10 AWG	24-10 AWG
		0.22 - 4 mm ²		
Short circuit current	A / s	480A/1s		
Rated wire size	mm ² / AWG	4 mm ²	10 AWG	10 AWG
Wire stripping length	mm / inches	9.5 mm / .37"		
Recommended torque	Nm / lb.in	0.5-0.8 Nm / 4.4-7.1 lb.in		

Selection

Description	Type	Order P/N	Packaging
Ground block V2 green/yellow	■ M 4/6.P	0165 113.16	50
Mounting on DIN 3 rail without screw :			
Ground block V0 green/yellow	■ D 4/6.P	0165 809.01	50

Accessories

End section	yellow	■ FEM6	2.8 mm	0103 062.21	20
	yellow V0	■ FEM6 V0	2.8 mm	0199 305.02	20
Separator end section	grey	□ SCF6	3 mm	0118 707.03	20

Feed through and ground terminal blocks

Single pole, multiclamp terminal blocks

Screw clamp, DIN 1-3



M 4/6.3A - 4 mm² blocks - 6 mm .238" spacing

Characteristics

		IEC NFC DIN	UL	CSA
Wire size mm ² / AWG	Solid	0.2 - 4	22-10AWG	12 AWG maxi.
	Stranded	0.22 - 4		
Voltage	V	800	600	600
Current	A	32	20	25
Rated wire size	mm ² / AWG	4 mm ²	10 AWG	12 AWG
Wire stripping length	mm / inches	9.5 mm / .37"		
Recommended torque	Nm / lb.in	0.5-0.8 Nm / 4.4-7.1 lb.in		

Selection

Description	Type	Order P/N	Packaging
Standard block grey	<input type="checkbox"/> M 4/6.3A	0115 468.20	50
Standard block blue	<input type="checkbox"/> M 4/6.3A.N	0125 468.22	50
Standard block beige V0	<input type="checkbox"/> M 4/6.3A.V0	0195 468.21	50

Accessories

End stop		BAM2 9.9 mm	0206 351.16	50
End section	grey <input type="checkbox"/>	FEM3A 3 mm	0116 576.15	20
	blue <input type="checkbox"/>	FEM3A 3 mm	0126 576.17	20
	yellow <input type="checkbox"/>	FEM3A 3 mm	0103 862.20	20
Assembled jumper bar (with IP20 protection)	2 poles	BJMI6 32 A	0176 663.00	10
	3 poles	BJMI6 32 A	0176 664.01	10
	4 poles	BJMI6 32 A	0176 665.02	10
	5 poles	BJMI6 32 A	0176 666.03	10
	10 poles	BJMI6 32 A	0176 667.04	10

M 4/6.4A - 4 mm² blocks - 6 mm .238" spacing

Characteristics

		IEC NFC DIN	UL	CSA
Wire size mm ² / AWG	Solid	0.2 - 4	22-10AWG	12 AWG maxi.
	Stranded	0.22 - 4		
Voltage	V	800	600	600
Current	A	32	20	25
Rated wire size	mm ² / AWG	4 mm ²	10 AWG	12 AWG
Wire stripping length	mm / inches	9.5 mm / .37"		
Recommended torque	Nm / lb.in	0.5-0.8 Nm / 4.4-7.1 lb.in		

Selection

Description	Type	Order P/N	Packaging
Standard block grey	<input type="checkbox"/> M 4/6.4A	0115 479.23	50
Standard block blue	<input type="checkbox"/> M 4/6.4A.N	0125 479.25	50
Standard block beige V0	<input type="checkbox"/> M 4/6.4A.V0	0195 479.24	50

Accessories

End stop		BAM2 9.9 mm	0206 351.16	50
End section	grey <input type="checkbox"/>	FEM4A 3 mm	0116 629.22	20
	blue <input type="checkbox"/>	FEM4A 3 mm	0126 629.24	20
	yellow <input type="checkbox"/>	FEM4A 3 mm	0103 863.21	20
Assembled jumper bar (with IP20 protection)	2 poles	BJMI6 32 A	0176 663.00	10
	3 poles	BJMI6 32 A	0176 664.01	10
	4 poles	BJMI6 32 A	0176 665.02	10
	5 poles	BJMI6 32 A	0176 666.03	10
	10 poles	BJMI6 32 A	0176 667.04	10

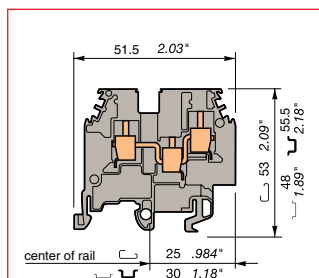

M 4/6.3A

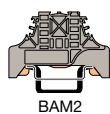

BAM2

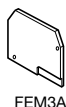

FEM3A



BJMI6

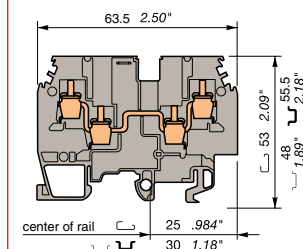

M 4/6.4A

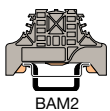

BAM2



FEM4A



BJMI6

Feed through and ground terminal blocks

Screw clamp, U U DIN 1-3

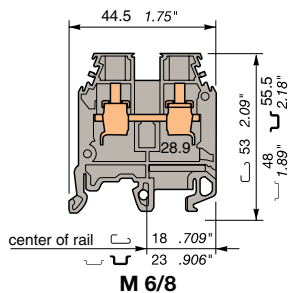

M 6/8 - 6 mm² blocks - 8 mm .315" spacing

Characteristics		IEC	UL	CSA
		NFC	DIN	
Wire size mm ² / AWG	Solid	0.5 - 10	22-8 AWG	24-8 AWG
	Stranded	0.5 - 6		
Voltage	V	800	600	600
Current	A	41	50	55
Short circuit current (M 6/8.PI)	A / s	720A/1s		
Rated wire size	mm ² / AWG	6 mm ²	8 AWG	8 AWG
Wire stripping length	mm / inches	12 mm / .47"		
Recommended torque	Nm / lb.in	0.8-1 Nm / 7.1-8.9 lb.in		

Selection

Description	Type	Order P/N	Packaging
Standard block grey	M 6/8	0115 118.11	50
Standard block blue	M 6/8.N	0125 118.13	50
Standard block yellow	M 6/8	0105 004.22	50
Standard block orange	M 6/8	0105 118.20	50
Standard block beige V0	M 6/8 V0	0195 118.12	50
Standard block blue V0	M 6/8.N.V0	0199 003.27	50
Standard block black	M 6/8	0400 185.20	50
Standard block red	M 6/8	0400 186.21	50
Standard block white	M 6/8	0400 187.22	50
Standard block green	M 6/8	0105 128.22	50
Ground block yellow body/ green marking (without rail contact)	M 6/8.N.V0	0199.003.27	50

Accessories

End stop	BAM2	9.9 mm	0206 351.16	50	
End section	grey	FEM6	2.8 mm	0118 368.16	20
	blue	FEM6	2.8 mm	0128 368.10	20
	orange	FEM6	2.8 mm	0103 126.16	20
	yellow	FEM6	2.8 mm	0103 062.21	20
	green	FEM6	2.8 mm	0103 125.15	20
	white	FEM6	2.8 mm	0103 312.20	20
	beige V0	FEM6V0	2.8 mm	0198 368.17	20
	blue V0	FEM6V0	2.8 mm	0199 302.07	20
	yellow V0	FEM6V0	2.8 mm	0199 305.02	20
	black	FEM6	2.8 mm	0107 005.25	20
Separator end section	grey	SCF6	3 mm	0118 707.03	20
Assembled jumper bar (with IP20 protection)	2 poles	BJM18	41 A	0176 669.16	10
	3 poles	BJM18	41 A	0176 670.13	10
	4 poles	BJM18	41 A	0176 671.00	10
	5 poles	BJM18	41 A	0176 672.01	10
	10 poles	BJM18	41 A	0176 673.02	10

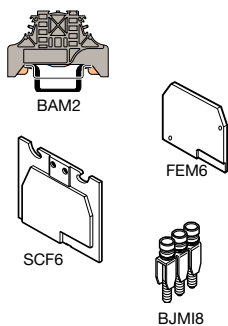

M 6/8.P - 6 mm² ground block with rail contact - 8 mm .315" spacing

Characteristics		IEC	UL	CSA
		NFC	DIN	
Wire size mm ² / AWG	Solid	0.5 - 10	22-8 AWG	24-8 AWG
	Stranded	0.5 - 6		
Short circuit current	A / s	720A/1s		
Rated wire size	mm ² / AWG	6 mm ²	8 AWG	8 AWG
Wire stripping length	mm / inches	12 mm / .47"		
Recommended torque	Nm / lb. in	0.8-1 Nm / 7.1-8.9 lb.in		

Selection

Description	Type	Order P/N	Packaging
Ground block V2 green/yellow	M 6/8.P	0165 114.17	50
Mounting on rail DIN 3 without screw :			
Ground block V2 green/yellow	D 6/8.P	0165 830.21	50

Accessories

End section	yellow	FEM6	2.8 mm	0103 062.21	20
	yellow V0	FEM6 V0	2.8 mm	0199 305.02	20
Separator end section	grey	SCF6	3 mm	0118 707.03	20

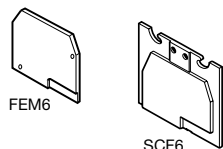
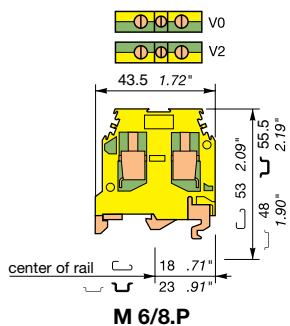

Feed through and ground terminal blocks

Screw clamp, DIN 1-3

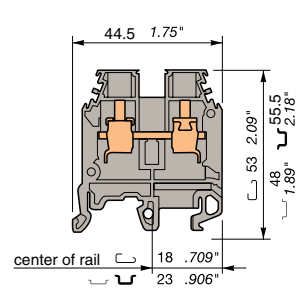

M 10/10

M 10/10 - 10 mm² blocks - 10 mm .394" spacing

Characteristics		IEC	UL	CSA
		NFC	DIN	
Wire size mm ² / AWG	Solid	0.5 - 16	20-6 AWG	18-6 AWG
	Stranded	0.5 - 10		
Voltage	V	800	600	600
Current	A	57	65	70
Short circuit current (M 10/10.PI)	A / s	1200A/1s		
Rated wire size	mm ² / AWG	10 mm ²	6 AWG	6 AWG
Wire stripping length	mm / inches	12 mm / .47"		
Recommended torque	Nm / lb.in	1.2-1.4 Nm / 10.6-12.4 lb.in		

Selection

Description	Type	Order P/N	Packaging
Standard block grey	M 10/10	0115 120.17	50
Standard block blue	M 10/10.N	0125 120.11	50
Standard block yellow	M 10/10	0105 120.26	50
Standard block beige V0	M 10/10 V0	0195 120.10	50
Standard block blue V0	M 10/10.N.V0	0199 004.20	50
Standard block black	M 10/10	0400 188.03	50
Standard block red	M 10/10	0400 189.04	50
Standard block white	M 10/10	0400 190.01	50
Ground block yellow body/ green marking (without rail contact)	M 10/10.N.V0	0199.003.27	50

Accessories

End stop		BAM2	9.9 mm	0206 351.16	50
End section	grey	FEM6	2.8 mm	0118 368.16	20
	blue	FEM6	2.8 mm	0128 368.10	20
	orange	FEM6	2.8 mm	0103 126.16	20
	yellow	FEM6	2.8 mm	0103 062.21	20
	green	FEM6	2.8 mm	0103 125.15	20
	white	FEM6	2.8 mm	0103 312.20	20
	black	FEM6	2.8 mm	0107 005.25	20
	beige V0	FEM6V0	2.8 mm	0198 368.17	20
	blue V0	FEM6V0	2.8 mm	0199 302.07	20
	yellow V0	FEM6V0	2.8 mm	0199 305.02	20
Separator end section	grey	SCF6	3 mm	0118 707.03	20
Assembled jumper bar (with IP20 protection)	2 poles	BJM10	57 A	0176 675.04	10
	3 poles	BJM10	57 A	0176 676.05	10
	4 poles	BJM10	57 A	0176 677.06	10
	5 poles	BJM10	57 A	0176 678.17	10
	10 poles	BJM10	57 A	0176 679.10	10

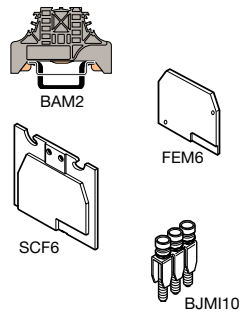

M 10/10.P - 10 mm² ground block with rail contact - 10 mm .394" spacing

Characteristics		IEC	UL	CSA
		NFC	DIN	
Wire size mm ² / AWG	Solid	0.5 - 16	20-6 AWG	18-6 AWG
	Stranded	0.5 - 10		
Short circuit current	A / s	1200A/1s		
Rated wire size	mm ² / AWG	10 mm ²	6 AWG	6 AWG
Wire stripping length	mm / inches	12 mm / .47"		
Recommended torque	Nm / lb.in	1.2-1.4 Nm / 10.6-12.4 lb.in		

Selection

Description	Type	Order P/N	Packaging
Ground block V2 green/yellow	M 10/10.P	0165 115.10	50
Ground block V0 green/yellow	M 10/10.P V0	0195 115.07	50

Accessories

Separator end section	grey	SCF6	3 mm	0118 707.03	20
-----------------------	------	------	------	-------------	----

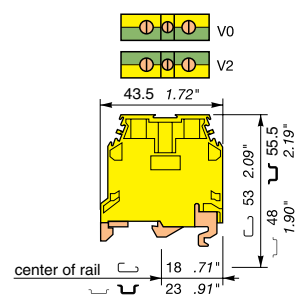

M 10/10.P

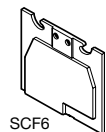

Feed through and ground terminal blocks

Screw clamp, C C DIN 1-3

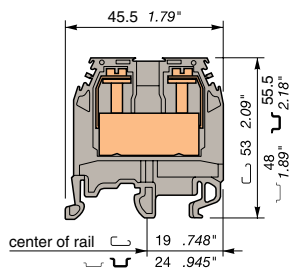

M 16/12

M 16/12 - 16 mm² blocks - 12 mm .473" spacing

Characteristics		IEC NFC DIN	UL	CSA
Wire size mm ² / AWG	Solid	0.5 - 25	18-6 AWG	8-4 AWG
	Stranded	0.5 - 16		
Voltage	V	800	600	600
Current	A	85	85	100
Short circuit current (M 16/12.PI)	A / s	1920A/1s		
Rated wire size	mm ² / AWG	16 mm ²	6 AWG	4 AWG
Wire stripping length	mm / inches	14 mm / .55"		
Recommended torque	Nm / lb.in	1.2-1.4 Nm / 10.6-12.4 lb.in		

Selection

Description	Type	Order P/N	Packaging
Standard block grey	<input type="checkbox"/> M 16/12	0115 129.14	50
Standard block blue	<input type="checkbox"/> M 16/12.N	0125 129.16	50
Standard block yellow	<input type="checkbox"/> M 16/12	0105 129.23	50
Standard block beige V0	<input type="checkbox"/> M 16/12 V0	0195 129.15	50
Standard block blue V0	<input type="checkbox"/> M 16/12.N.V0	0199 005.21	50
Standard block black	<input type="checkbox"/> M 16/12	0400 191.26	20
Standard block red	<input type="checkbox"/> M 16/12	0400 192.27	20
Standard block white	<input type="checkbox"/> M 16/12	0400 193.20	20
Ground block yellow body/ green marking (without rail contact)	<input type="checkbox"/> M 16/12.N.VO	0165 453.23	50

Accessories

End stop		BAM2	9.9 mm	0206 351.16	50
End section	grey	<input type="checkbox"/> FEM12	3 mm	0118 618.01	20
	blue	<input type="checkbox"/> FEM12	3 mm	0128 618.03	20
	yellow	<input type="checkbox"/> FEM12	3 mm	0103 065.24	20
	beige V0	<input type="checkbox"/> FEM12.V0	3 mm	0198 618.02	20
	blue V0	<input type="checkbox"/> FEM12.V0	3 mm	0199 303.00	20
Separator end section	grey	<input type="checkbox"/> SCF12	3 mm	0118 707.03	20
Assembled jumper bar (with IP20 protection)	2 poles	BJMI12	76 A	0179 626.06	10
	3 poles	BJMI12	76 A	0179 628.10	10
	4 poles	BJMI12	76 A	0179 629.11	10
	5 poles	BJMI12	76 A	0179 630.16	10
	10 poles	BJMI12	76 A	0179 631.03	10

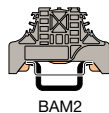

BAM2

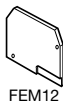

FEM12

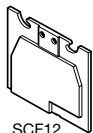

SCF12



BJMI12

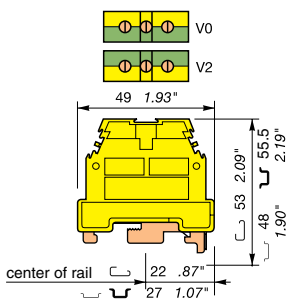

M 16/12.P

M 16/12.P - 16 mm² ground block with rail contact - 12 mm .473" spacing

Characteristics		IEC NFC DIN	UL	CSA
Wire size mm ² / AWG	Solid	4 - 25	14-4 AWG	10-6 AWG
	Stranded	4 - 16		
Short circuit current	A / s	1920A/1s		
Rated wire size	mm ² / AWG	16 mm ²	4 AWG	6 AWG
Wire stripping length	mm / inches	14 mm / .55"		
Recommended torque	Nm / lb.in	1.2-1.4 Nm / 10.6-12.4 lb.in		

Selection

Description	Type	Order P/N	Packaging
Ground block V2 green/yellow	<input type="checkbox"/> M 16/12.P	0165 130.23	20
Ground block V0 green/yellow	<input type="checkbox"/> M 16/12.P V0	0195 130.12	20

Accessories

Separator end section	grey	<input type="checkbox"/> SCFM6	3 mm	0114 825.05	20
-----------------------	------	--------------------------------	------	-------------	----

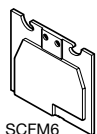

SCFM6

Feed through and ground terminal blocks

Screw clamp, DIN 1-3



M 35/16 - 35 mm² blocks - 16 mm .630" spacing

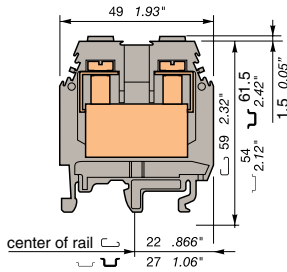

M 35/16

Characteristics		IEC	UL	CSA
		NFC	DIN	
Wire size mm ² / AWG	Solid	1 - 50	10 - 0 AWG	10 - 0 AWG
	Stranded	1 - 35	10 - 0 AWG	10 - 0 AWG
Voltage	V	800	600	600
Current	A	125	150	140
Short circuit current (M 35/16.P)	A / s	4200A/1s		
Rated wire size	mm ² / AWG	35 mm ²	0 AWG	0 AWG
Wire stripping length	mm / inches	17 mm / .669"		
Recommended torque	Nm / lb.in	2.8-3 Nm / 24.9-26.7 lb.in		

Selection

Description	Type	Order P/N	Packaging
Standard block grey	<input type="checkbox"/> M 35/16	0115 124.07	20
Standard block blue	<input type="checkbox"/> M 35/16.N	0125 124.01	20
Standard block yellow	<input type="checkbox"/> M 35/16	0105 124.16	20
Standard block beige V0	<input type="checkbox"/> M 35/16 V0	0195 124.00	20
Standard block blue V0	<input type="checkbox"/> M 35/16.N.V0	0199 006.22	20
Standard block black	<input type="checkbox"/> M 35/16	0400 194.21	20
Standard block red	<input type="checkbox"/> M 35/16	0400 195.22	20
Standard block white	<input type="checkbox"/> M 35/16	0400 196.23	20
Ground block yellow body/ green marking (without rail contact)	<input type="checkbox"/> M 35/16.N.V0	0165 454.24	20

Accessories

End stop		BAM2	9.9 mm	0206 351.16	50
End section	grey	<input type="checkbox"/> FEM16	3 mm	0118 233.27	20
	blue	<input type="checkbox"/> FEM16	3 mm	0128 233.21	20
	yellow	<input type="checkbox"/> FEM16	3 mm	0103 061.20	20
	beige V0	<input type="checkbox"/> FEM16 V0	3 mm	0198 233.20	20
	blue V0	<input type="checkbox"/> FEM16 V0	3 mm	0199 304.01	20
Separator end section	grey	<input type="checkbox"/> SCF16	3 mm	0113 101.17	20
Assembled jumper bar (with IP20 protection)	2 poles	BJMI16	110 A	0206 217.00	10
	3 poles	BJMI16	110 A	0206 218.11	10
	4 poles	BJMI16	110 A	0206 219.12	10
	5 poles	BJMI16	110 A	0206 220.17	10
	10 poles	BJMI16	110 A	0206 221.04	10

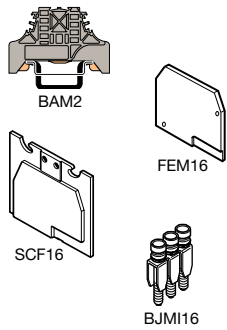

M 35/16.P - 35 mm² ground block with rail contact - 16 mm .630" spacing

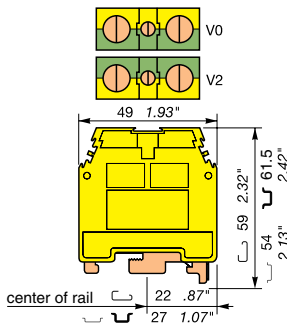

M 35/16.P

Characteristics		IEC	UL	CSA
		NFC	DIN	
Wire size mm ² / AWG	Solid	4 - 50	10-0 AWG	10-0 AWG
	Stranded	4 - 35		
Short circuit current	A / s	4200A/1s		
Rated wire size	mm ² / AWG	35 mm ²	0 AWG	0 AWG
Wire stripping length	mm / inches	17 mm / .67"		
Recommended torque	Nm / lb.in	2.8-3 Nm / 24.9-26.7 lb.in		

Selection

Description	Type	Order P/N	Packaging
Ground block V2 green/yellow	<input type="checkbox"/> M 35/16.P	0165 111.14	20
Ground block V0 green/yellow	<input type="checkbox"/> M 35/16.P.V0	0195 111.03	20

Feed through and ground terminal blocks

Screw clamp, 3 3 DIN 1-3

M 70/22 - 70 mm² blocks - 22 mm .866" spacing

Characteristics

		IEC NFC DIN	UL	CSA
Wire size mm ² / AWG	Solid	16 - 95	4-00 AWG	4-00 AWG
	Stranded	16 - 70		
Voltage	V	800	600	600
Current	A	192	175	150
Short circuit current (M 70/22.PI)	A / s	8400A/1s		
Short circuit current (M 70/22.P)	A / s	8400A/1s	6600A/1s	6600A/1s
Rated wire size	mm ² / AWG	70 mm ²	00 AWG	00 AWG
Wire stripping length	mm / inches	25 mm / .98"		
Recommended torque	Nm / lb.in	6-7 Nm / 53.4-62.3 lb.in		

Selection

Description	Type	Order P/N	Packaging
Standard block grey	<input type="checkbox"/> M 70/22	0115 216.13	10
Standard block blue	<input type="checkbox"/> M 70/22.N	0125 216.15	10
Standard block beige V0	<input type="checkbox"/> M 70/22.V0	0195 216.14	10
Ground block yellow body/ green marking (without rail contact)	<input type="checkbox"/> M 70/22.PI	0165 596.13	10

Accessories

End stop	BADH	12 mm	0116 900.27	50	
	BAMH	9.1 mm	0114 836.00	50	
End section	grey	<input type="checkbox"/> FEM22	3 mm	0113 065.15	10
	yellow	<input type="checkbox"/> FEM22	3 mm	0103 881.14	10
	beige V0	<input type="checkbox"/> FEM22 V0	3 mm	0193 065.16	10
Separator end section	grey	<input type="checkbox"/> SCF22	3 mm	0113 851.16	10

M 70/22.P - 70 mm² ground block with rail contact - 22 mm .866" spacing ^①

Selection

Description	Type	Order P/N	Packaging
Ground block V2 green/yellow	<input type="checkbox"/> M 70/22.P	0399 024.23	10

M 95/26 - 95 mm² blocks - 26 mm 1.02" spacing

Characteristics

		IEC NFC DIN	UL	CSA
Wire size mm ² / AWG	Solid	35 - 120	4-0000 AWG	4-0000 AWG
	Stranded	35 - 95		
Voltage	V	1000	600	600
Current	A	232	230	250
Short circuit current (M 4/6.PI)	A / s	11400A/1s		
Rated wire size	mm ² / AWG	95 mm ²	0000 AWG	0000 AWG
Wire stripping length	mm / inches	26 mm / 1.02"		
Recommended torque	Nm / lb.in	8.5-9.5 Nm / 74-83 lb.in		

Selection

Description	Type	Order P/N	Packaging
Standard block grey	<input type="checkbox"/> M 95/26	0115 556.10	10
Standard block blue	<input type="checkbox"/> M 95/26.N	0125 556.12	10
Standard block beige V0	<input type="checkbox"/> M 95/26.V0	0195 556.11	10
Ground block yellow body/ green marking (without rail contact)	<input type="checkbox"/> M 95/26.PI	0165 556.22	10

Accessories

End stop	BADH	12 mm	0116 900.27	50
	BAMH	9.1 mm	0114 836.00	50

M 95/26.P - 95 mm² ground block with rail contact - 26 mm 1.02" spacing ^①

Characteristics

		IEC NFC DIN	UL	CSA
Wire size mm ² / AWG	Solid	35 - 120	4-0000 AWG	4-0000 AWG
	Stranded	35 - 95		
Short circuit current	A / s	11400A/1s		
Rated wire size	mm ² / AWG	95 mm ²	0000 AWG	0000 AWG
Wire stripping length	mm / inches	26 mm / 1.02"		
Recommended torque	Nm / lb.in	8.5-9.5 Nm / 74-83 lb.in		

Selection

Description	Type	Order P/N	Packaging
Ground block V2 green/yellow	<input type="checkbox"/> M 95/26.P	0399 176.00	10

^① Mounting on PR4 rail only.

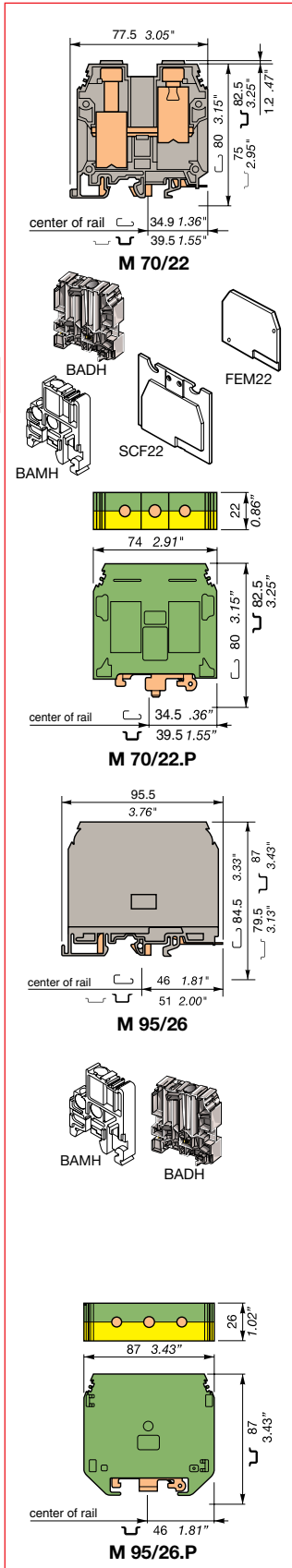

Power terminal blocks

Screw clamp, U DIN 3



D 150/31.D10 - 150 mm² blocks - 31 mm 1.22" spacing

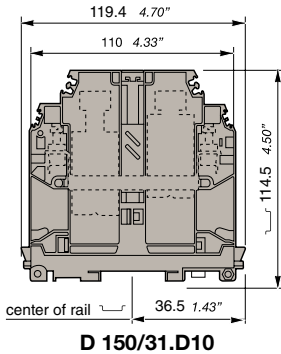

Characteristics		IEC NFC DIN	UL	CSA
Wire size main circuit mm ² / AWG	Solid	25 - 185	4 AWG-350 MCM	
	Stranded	35 - 150	2 AWG-300 MCM	
Wire size output mm ² / AWG	Solid	0.5 - 16		
	Stranded	0.5 - 10 18-6 AWG		
Voltage	V	1000	600	600
Current main circuit	A	309	445	445
Current output	A	57	70	70
Rated wire size main circuit	mm ² / AWG	150 mm ²	300 MCM	300 MCM
Rated wire size output	mm ² / AWG	10 mm ²	6 AWG	6 AWG
Wire stripping length main circuit	mm / inches	35 mm / 1.37"		
Wire stripping length output	mm / inches	12 mm / 0.47"		
Recommended torque main circuit	Nm / lb.in	10-30 Nm / 88.5-260 lb.in		
Recommended torque output	Nm / lb.in	1.2-1.4 Nm / 10.6-12.3 lb.in		

Selection

Description	Type	Order P/N	Packaging
Standard block grey	<input type="checkbox"/> D 150/31.D10	0399 715.04	10
Standard block blue	<input type="checkbox"/> D 150/31.D10.N	0399 717.06	10
Ground block yellow body/ green marking (without rail contact)	<input type="checkbox"/> D150/31.D10.PI	0399 716.05	10

D 240/36.D10 - 240 mm² blocks - 36 mm 1.41" spacing

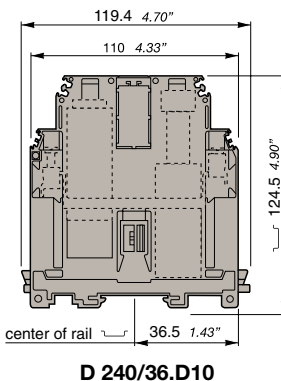

Characteristics		IEC NFC DIN	UL	CSA
Wire size main circuit mm ² / AWG	Solid	50 - 300	0 AWG-600 MCM	
	Stranded	35 - 240	2 AWG-500 MCM	
Wire size output mm ² / AWG	Solid	0.5 - 16		
	Stranded	0.5 - 10 18-6 AWG		
Voltage	V	1000	600	600
Current main circuit	A	415	400	400
Current output	A	57	70	70
Rated wire size main circuit	mm ² / AWG	240 mm ²	500 MCM	500 MCM
Rated wire size output	mm ² / AWG	10 mm ²	6 AWG	6 AWG
Wire stripping length main circuit	mm / inches	35 mm / 1.37"		
Wire stripping length output	mm / inches	12 mm / 0.47"		
Recommended torque main circuit	Nm / lb.in	14-30 Nm / 124-260 lb.in		
Recommended torque output	Nm / lb.in	1.2-1.4 Nm / 10.6-12.3 lb.in		

Selection

Description	Type	Order P/N	Packaging
Standard block grey	<input type="checkbox"/> D 240/36.D10	0399 704.12	5
Standard block blue	<input type="checkbox"/> D 240/36.D10.N	0399 706.14	5
Ground block yellow body/ green marking (without rail contact)	<input type="checkbox"/> D 240/36.D10.PI	0399 705.13	5

Accessories

Accessories	Type	Order P/N	Packaging
End stop	BADH 12 mm	0116 900.27	50
	BAMH 9.1 mm	0114 836.00	50

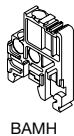

Feed through terminal blocks

Double-deck

Screw clamp, 5 mm DIN 1-3

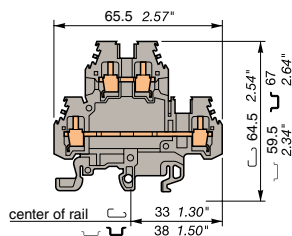

MA 2,5/5.D2

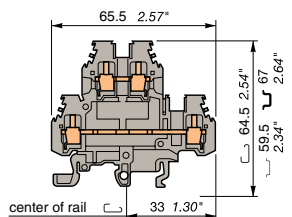

M 4/6.D2

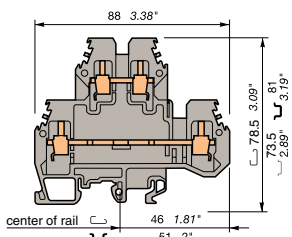

M 6/8.D2



BADH

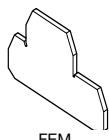

FEM...

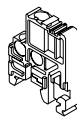

BAMH



SCF6D

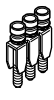

BJM...



CBM5D

MA 2,5/5.D2 - 2.5 mm² blocks - 5 mm .200" spacing

Characteristics

		IEC NFC DIN	UL	CSA
Wire size mm ² / AWG	Solid	0.2 - 4	22-12 AWG	20-12 AWG
	Stranded	0.22 - 2.5		
Voltage	V	630	300	300
Current	A	24	20	25
Rated wire size	mm ² / AWG	2.5 mm ²	12 AWG	12 AWG
Wire stripping length	mm / inches	9 mm / .354"		
Recommended torque	Nm / lb.in	0.4-0.6 Nm / 3.5-5.3 lb.in		

M 4/6.D2 - 4 mm² blocks - 6 mm .238" spacing

Characteristics

		IEC NFC DIN	UL	CSA
Wire size mm ² / AWG	Solid	0.2 - 4	22-12 AWG	24-12 AWG
	Stranded	0.22 - 4		
Voltage	V	800	600	300
Current	A	32	20	25
Rated wire size	mm ² / AWG	4 mm ²	12 AWG	12 AWG
Wire stripping length	mm / inches	8.5 mm / .33"		
Recommended torque	Nm / lb.in	0.5-0.8 Nm / 4.4-7.1 lb.in		

M 6/8.D2 - 6 mm² blocks - 8 mm .315" spacing

Characteristics

		IEC NFC DIN	UL	CSA
Wire size mm ² / AWG	Solid	0.5 - 10	18-8 AWG	8 AWG
	Stranded	0.5 - 6		
Voltage	V	800	600	600
Current	A	41	50	45
Rated wire size	mm ² / AWG	6 mm ²	8 AWG	8 AWG
Wire stripping length	mm / inches	12 mm / .47"		
Recommended torque	Nm / lb.in	0.8-1 Nm / 7.1-8.9 lb.in		

MA 2,5/5.D2...Selection

Description	Type	Order P/N		Packaging
Standard block grey	<input type="checkbox"/>	MA 2,5/5.D2	0115 490.13	50
Standard block blue	<input type="checkbox"/>	MA 2,5/5.D2.N	0125 490.15	50
Standard block beige V0	<input type="checkbox"/>	MA 2,5/5.D2.V0	0195 490.14	50

M 4/6.D2...Selection

Standard block grey	<input type="checkbox"/>	M 4/6.D2	0115 271.22	50
Standard block beige V0	<input type="checkbox"/>	M 4/6.D2.V0	0195 271.23	50
Standard block green	<input type="checkbox"/>	M 4/6.D2	0105 044.21	50
Standard block white	<input type="checkbox"/>	M 4/6.D2	0105 046.23	50
Standard block black	<input type="checkbox"/>	M 4/6.D2	0105 047.24	50
Standard block red	<input type="checkbox"/>	M 4/6.D2	0105 048.05	50
Standard block orange	<input type="checkbox"/>	M 4/6.D2	0105 049.06	50
Standard block yellow	<input type="checkbox"/>	M 4/6.D2	0105 045.22	50

M 6/8.D2...Selection

Standard block grey	<input type="checkbox"/>	M 6/8.D2	0115 501.12	50
Standard block beige V0	<input type="checkbox"/>	M 6/8.D2.V0	0195 501.13	50

Accessories

End stop		BADH	12 mm	0116 900.27	50	
		BAMH	9.1 mm	0114 836.00	50	
End section	grey	<input type="checkbox"/>	FEM6D	1 mm ①②	0118 499.23	20
	blue	<input type="checkbox"/>	FEM6D	1 mm ①②	0128 499.25	20
	grey	<input type="checkbox"/>	FEM8D1	1 mm ③	0116 656.25	20
	grey	<input type="checkbox"/>	FEM8D2	4 mm ③	0116 657.26	20
Separator end section	grey	<input type="checkbox"/>	SCF6D	1 mm ②	0118 495.17	20
Assembled jumper bar (with IP20 protection)	2 poles		BJMI5D	24 A ①	0176 736.21	10
	3 poles		BJMI5D	24 A ①	0176 737.22	10
	4 poles		BJMI5D	24 A ①	0176 738.03	10
	5 poles		BJMI5D	24 A ①	0176 739.04	10
	10 poles		BJMI5D	24 A ①	0176 740.11	10
	Assembled jumper bar (with IP20 protection)	2 poles		BJMI6D	32 A ②	0179 668.20
3 poles			BJMI6D	32 A ②	0179 669.21	10
4 poles			BJMI6D	32 A ②	0179 670.26	10
5 poles			BJMI6D	32 A ②	0179 671.13	10
10 poles			BJMI6D	32 A ②	0179 672.14	10
Assembled jumper bar (with IP20 protection)		2 poles		BJMI8	41 A ③	0176 669.16
	3 poles		BJMI8	41 A ③	0176 670.13	10
	4 poles		BJMI8	41 A ③	0176 671.00	10
	5 poles		BJMI8	41 A ③	0176 672.01	10
	10 poles		BJMI8	41 A ③	0176 673.02	10
	Shield connector		CBM5D	0.5 mm ①②	0173 530.24	50

① Only for MA 2,5/5.D2...

② Only for M 4/6.D2...

③ Only for M 6/8.D2...

Feed through terminal blocks

Triple - deck

Screw clamp, \sqcup DIN 3

D 4/6.T3 - 4 mm² blocks - 6 mm .238" spacing

Characteristics

		IEC NFC DIN	UL	CSA
Wire size mm ² / AWG	Solid	0.2 - 4	22-12 AWG	22-12 AWG
	Stranded	0.22 - 4		
Voltage	V	500	300	300
Current	A	32	20	20
Rated wire size	mm ² / AWG	4 mm ²	12 AWG	12 AWG
Wire stripping length	mm / inches	9.5 mm / .37"		
Recommended torque	Nm / lb.in	0.5-0.8 Nm / 4.4-7.1 lb.in		

Selection

Description	Type	Order P/N	Packaging
Standard block grey	<input type="checkbox"/> D 4/6.T3	0299 683.01	25

M 4/6.T3.P - 4 mm² block - 6 mm .238" spacing

Characteristics

		IEC NFC DIN	UL	CSA
Wire size mm ² / AWG	Solid	0.2 - 4	22-12 AWG	22-12 AWG
	Stranded	0.22 - 4		
Voltage	V	500	300	300
Current	A	32	20	20
Short circuit current	A/s	480 A/1s		
Rated wire size	mm ² / AWG	4 mm ²	12 AWG	12 AWG
Wire stripping length	mm / inches	9.5 mm / .37"		
Recommended torque	Nm / lb.in	0.5-0.8 Nm / 4.4-7.1 lb.in		

Selection

Description	Type	Order P/N	Packaging
Standard block grey	<input type="checkbox"/> M 4/6.T3.P	0299 684.02	25

Accessories

End stop	BADH 12 mm	0116 900.27	50
Assembled jumper bar (without IP20 protection)	2 poles	BJM62 41 A	0173 217.26
	3 poles	BJM62 41 A	0173 218.07
	4 poles	BJM62 41 A	0173 219.00
	5 poles	BJM62 41 A	0173 221.22
	10 poles	BJM62 41 A	0173 226.27

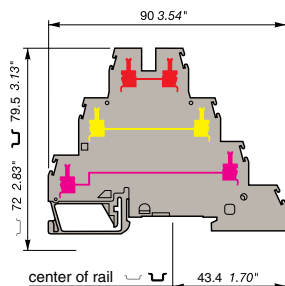

M 4/6.T3

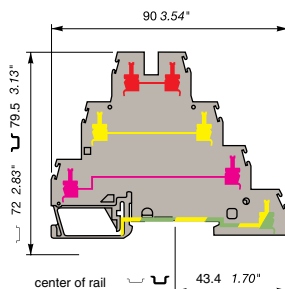

M 4/6.T3.P

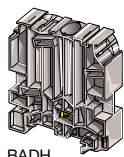

BADH



BJM62

Three level sensor

Terminal blocks without ground connection

Screw clamp, U DIN 3

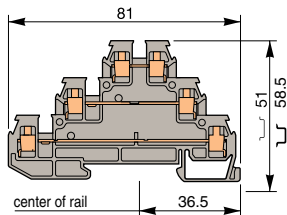

D 2,5/6.D

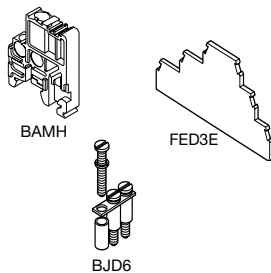

D 2,5/6.D - 2.5 mm² blocks - 6 mm .238" spacing

Characteristics

		IEC NFC	DIN	UL	CSA
Wire size mm ² / AWG	Solid	0.2 - 2.5		20-12 AWG	22-14 AWG
	Stranded	0.22 - 2.5			
Voltage	V	380 Gr.c		300	300
Current	A	22		26	20
Rated wire size	mm ² / AWG	2.5 mm ²		12 AWG	14 AWG
Wire stripping length	mm / inches	6 mm / .24"			
Recommended torque	Nm / lb.in	0.4-0.6 Nm / 3.5-5.3 lb.in			

Selection

Description	Type	Order P/N	Packaging
Three level block for sensor grey	<input type="checkbox"/> D 2,5/6.D	0115 541.11	25

Accessories

End stop	BAMH	9.1 mm	0114 836.00	50	
End section	grey <input type="checkbox"/> FED3E	3 mm	0116 771.20	20	
Assembled jumper bar (without IP20 protection)	2 poles	BJD6	22 A	0178 024.25	10
	3 poles	BJD6	22 A	0178 025.26	10
	4 poles	BJD6	22 A	0178 026.27	10
	5 poles	BJD6	22 A	0178 027.20	10
	10 poles	BJD6	22 A	0178 032.25	10

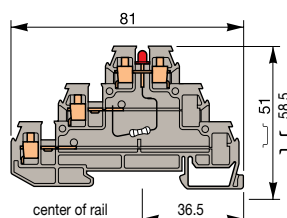

D 2,5/6.DL

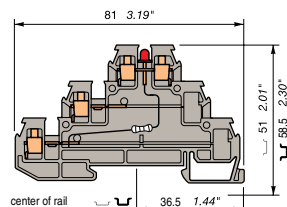

D 2,5/6.DL1

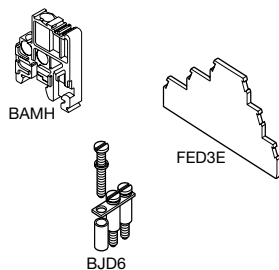

D 2,5/6.DL - 2.5 mm² blocks - 6 mm .238" spacing

Characteristics

		IEC NFC	DIN	UL	CSA
Wire size mm ² / AWG	Solid	0.2 - 2.5		20-12 AWG	22-14 AWG
	Stranded	0.22 - 2.5			
Voltage	V	380 Gr.c		300 ①	300 ①
Current	A	22		26	20
Rated wire size	mm ² / AWG	2.5 mm ²		12 AWG	14 AWG
Wire stripping length	mm / inches	6 mm / .24"			
Recommended torque	Nm / lb.in	0.4-0.6 Nm / 3.5-5.3 lb.in			

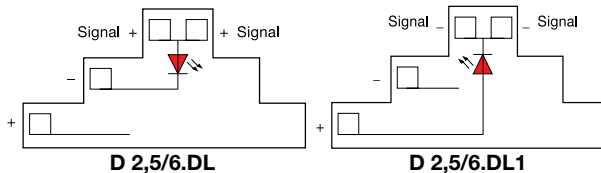

Selection

Description	Type	Order P/N	Packaging
Three level block for sensor with red LED indication	grey <input type="checkbox"/> D 2,5/6.DL	0115 537.05	25
LED indication	grey <input type="checkbox"/> D 2,5/6.DL1	0115 538.16	25

Accessories

End stop	BAMH	9.1 mm	0114 836.00	50	
End section	grey <input type="checkbox"/> FED3E	3 mm	0116 771.20	20	
Assembled jumper bar (without IP20 protection)	2 poles	BJD6	22 A	0178 024.25	10
	3 poles	BJD6	22 A	0178 025.26	10
	4 poles	BJD6	22 A	0178 026.27	10
	5 poles	BJD6	22 A	0178 027.20	10
	10 poles	BJD6	22 A	0178 032.25	10

① 24 VDC on LED circuit.

Three level sensor

Terminal blocks with ground connection

Screw clamp, \mathcal{L} DIN 3

D 2,5/6.DPA1 - 2.5 mm² blocks - 6 mm .238" spacing

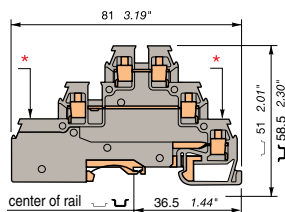

D 2,5/6.DPA1

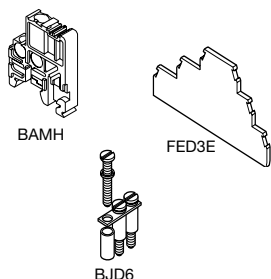

Characteristics

Wire size mm ² / AWG	Solid Stranded	IEC NFC DIN	UL	CSA
		0.2 - 2.5 0.22 - 2.5	20-12 AWG	22-14 AWG
Voltage	V	380 Gr.c	300	300
Current	A	22	26	20
Short circuit current	A / s	300A/1s		
Rated wire size	mm ² / AWG	2.5 mm ²	12 AWG	14 AWG
Wire stripping length	mm / inches	6 mm / .24"		
Recommended torque	Nm / lb.in	0.4-0.6 Nm / 3.5-5.3 lb.in		

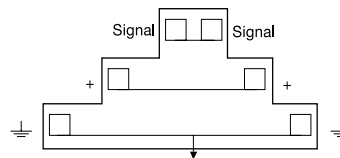

Selection

Description	Type	Order P/N	Packaging	
Three level block for power with ground on lower level	grey <input type="checkbox"/>	D 2,5/6.DPA1	0115 643.27	25

* Green/yellow marking on lower deck

Accessories

End stop		BAMH 9.1 mm	0114 836.00	50
End section	grey <input type="checkbox"/>	FED3E 3 mm	0116 771.20	20
Assembled jumper bar (without IP20 protection)	2 poles	BJD6 22 A	0178 024.25	10
	3 poles	BJD6 22 A	0178 025.26	10
	4 poles	BJD6 22 A	0178 026.27	10
	5 poles	BJD6 22 A	0178 027.20	10
	10 poles	BJD6 22 A	0178 032.25	10

D 2,5/6.DPAL1 - 2.5 mm² blocks - 6 mm .238" spacing

Characteristics

Wire size mm ² / AWG	Solid Stranded	IEC NFC DIN	UL	CSA
		0.2 - 2.5 0.22 - 2.5	20-12 AWG	22-14 AWG
Voltage	V	380 Gr.c	300 (1)	300 (1)
Current	A	22	26	20
Short circuit current	A / s	300A/1s		
Rated wire size	mm ² / AWG	2.5 mm ²	12 AWG	14 AWG
Wire stripping length	mm / inches	6 mm / .24"		
Recommended torque	Nm / lb.in	0.4-0.6 Nm / 3.5-5.3 lb.in		

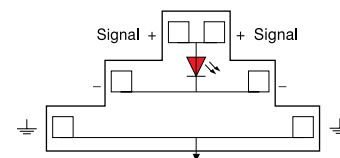

(1) 24 VDC on LED circuit.

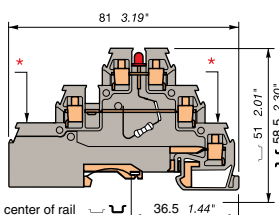

D 2,5/6.DPAL1

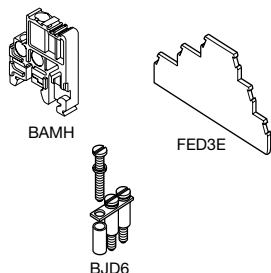

Selection

Description	Type	Order P/N	Packaging	
Three level block for sensor with ground on lower level and red LED indicator	grey <input type="checkbox"/>	D 2,5/6.DPAL1	0115 642.26	25

* Green/yellow marking on lower deck

Accessories

End stop		BAMH 9.1 mm	0114 836.00	50
End section	grey <input type="checkbox"/>	FED3E 3 mm	0116 771.20	20
Assembled jumper bar (without IP20 protection)	2 poles	BJD6 22 A	0178 024.25	10
	3 poles	BJD6 22 A	0178 025.26	10
	4 poles	BJD6 22 A	0178 026.27	10
	5 poles	BJD6 22 A	0178 027.20	10
	10 poles	BJD6 22 A	0178 032.25	10

Terminal blocks for distribution boxes

Double-deck + protection

Screw clamp, \sqcup DIN 3

D 4/6... - 4 mm² blocks - 6 mm .238" spacing

Characteristics

		IEC		UL	CSA
		NFC	DIN		
Wire size mm ² / AWG	Solid	0.2 - 4 mm ²		18-12 AWG	18-12 AWG
	Stranded	0.2 - 4 mm ²			
Ground bar (1)		10 x 3 mm			
Voltage	V	320 (1) / 400 (2)		300	300
		400 (3)			
Pulse	kV	4 (1) / 6 (2)			
		6 (3)			
Rated Current	A	30		20	20
Short circuit current (2)	A / s	480 A/1s			
Rated wire size	mm ² / AWG	4 mm ² / A4		12 AWG	12 AWG
Wire stripping length	mm / inches	9.5 mm / .37"			
Recommended torque	Nm / lb.in	0.4 - 0.8 Nm / 3.5 - 7 lb.in			

Selection

Description	Type	Order P/N	Packaging	
D 4/6.NTLP				
1 circuit "disconnect neutral" with busbar connection, blue marking				
1 circuit "feed-through"				
1 circuit "ground" connected to the rail, green-yellow marking				
Double deck block	grey <input type="checkbox"/>	D 4/6.NTLP	0110 439.22	20
D 4/6.NLP				
1 circuit "neutral", blue marking				
1 circuit "feed-through"				
1 circuit "ground" connected to the rail, green-yellow marking				
Double deck block	grey <input type="checkbox"/>	D 4/6.NLP	0110 440.07	20
D 4/6.LLP				
2 circuits "feed-through"				
1 circuit "ground" connected to the rail, green-yellow marking				
Double deck block	grey <input type="checkbox"/>	D 4/6.LLP	0110 441.24	20
D 4/6...L				
1 circuit "neutral", blue marking ①				
1 circuit "feed-through" ①				
2 circuits "feed-through" ②				
Double deck block ①	grey <input type="checkbox"/>	D 4/6.NL	0110 447.22	20
Double deck block ②	grey <input type="checkbox"/>	D 4/6.LL	0110 442.25	20

Accessories

End stop		BAMH	9.1 mm	0114 836.00	50
End section	grey <input type="checkbox"/>	FED6	1 mm	0116 964.12	20
Separate end section		SCFD	1.5 mm	0114 117.07	10
Circuit separator	white <input type="checkbox"/>	SCD		0103 189.26	10
Assembled jumper bad (without IP20 protection)	2 poles	BJM62	32 A	0173 217.26	10
	3 poles	BJM62	32 A	0173 218.07	10
	4 poles	BJM62	32 A	0173 219.00	10
	5 poles	BJM62	32 A	0173 221.22	10
	10 poles	BJM62	32 A	0173 226.27	10

① Between "feed-through" and "neutral" circuits
 ② Between 2 "feed-through" circuits (side by side)
 ③ For blocks : D 4/6.NLP, D 4/6.LLP, D 4/6...L

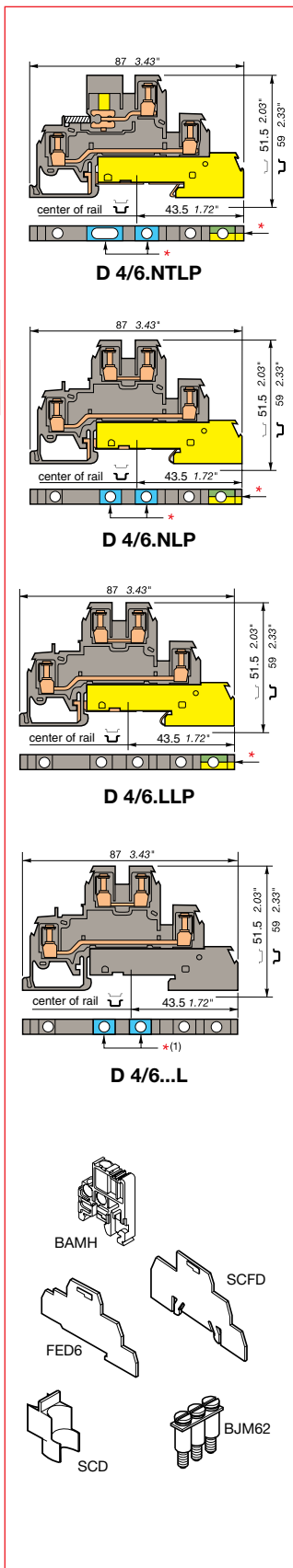

Double deck + protection terminal blocks for distribution boxes

Screw clamp, \sqcup DIN 3



D 4/6.LNTP - 4 mm² closed blocks - 17.8 mm .700" spacing

Characteristics

		IEC NFC DIN	UL	CSA
Wire size mm ² / AWG	Solid	0.2 - 4 mm ²	18-12 AWG	18-12 AWG
	Stranded	0.2 - 4 mm ²		
Voltage	V	320 ^① /400 ^①	300 V	300 V
Pulse	kV	4 ^② / 6 ^②		
Rated Current	A	30 A	20 A	20 A
Short circuit current ^①	A / s	480 A/1s ^①		
Rated wire size	mm ² / AWG	4 mm ²	12 AWG	12 AWG
Wire stripping length	mm / inches	9.5 mm / .37"		
Recommended torque ^②	Nm / lb.in	0.5-0.8 Nm / 4.4-7.1 lb.in ^②		

Selection

Description	Type	Order P/N	Packaging
-------------	------	-----------	-----------

D 4/6.LNTP1

3 circuits "disconnect neutral" with busbar connection
 3 circuits "feed-through"
 3 circuits "ground" connected to the rail

Closed block blue, grey and green-yellow	4/6.LNTP1	0110 264.02	10
------------------------------------------	-----------	-------------	----

D 4/6.LNTP2

3 circuits "neutral"
 3 circuits "feed-through"
 3 circuits "ground" connected to the rail

Closed block blue, grey and green-yellow	4/6.LNTP2	0110 327.21	10
------------------------------------------	-----------	-------------	----

D 4/6.LNTP3

1 circuits "disconnect neutral" with busbar connection
 3 circuits "feed-through"
 1 circuit "ground" connected to the rail

Closed block grey and green-yellow	4/6.LNTP3	0110 269.17	10
------------------------------------	-----------	-------------	----

D 4/6.LNTP4

6 circuits "feed-through"
 3 circuits "ground" connected to the rail

Closed block grey and green-yellow	4/6.LNTP4	0110 328.02	10
------------------------------------	-----------	-------------	----

D 4/6.LNTP6

6 circuits "feed-through"

Closed block grey	D 4/6.LNTP6	0110 331.25	10
-------------------	-------------	-------------	----

Accessories

End stop		BAMH 9.1 mm	0114 836.00	50
Separator end section	grey	SCFD 1,5 mm	0114 117.07	10
Circuit separator	white	SCD	0103 189.26	10
Assembled jumper bar (without IP20 protection)	2 poles	BJM62 32 A	0173 217.26	10
	3 poles	BJM62 32 A	0173 218.07	10
	4 poles	BJM62 32 A	0173 219.00	10
	5 poles	BJM62 32 A	0173 221.22	10
	10 poles	BJM62 32 A	0173 226.27	10
Busbar		B03 1000 x 10 x 3 mm	0 164 406.24	
Screw clamp for busbar		SFB1 0.5 to 35 mm ²	0 163 860.05	
		SFB2 16 to 35 mm ²	0 168 956.06	

^① Except for D 4/6.LNTP6

^② For D 4/6.LNTP6 : 0.4-0.8 Nm / 3.5-7 lb.in

^③ For D 4/6.LNTP1 and D 4/6.LNTP3 : between "feed-through" and neutral circuits

^④ For D 4/6.LNTP1 and D 4/6.LNTP3 : between 2 "feed-through" circuits (side by side). For other blocks : with no condition.

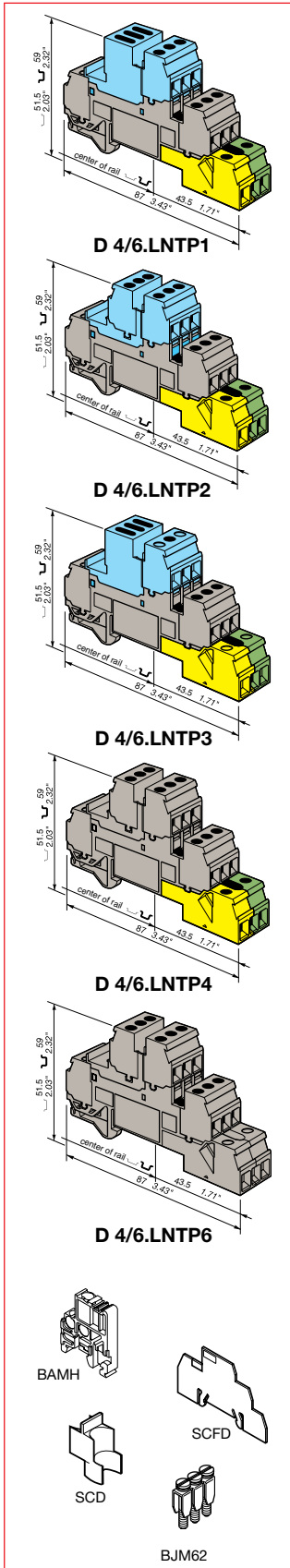

Screw clamp

Interruptible terminal blocks for neutral circuit

Screw clamp, C C DIN 1 - 3

MA 2,5/5.NT- 2.5 mm² block - 5 mm .200" spacing

Characteristics

		IEC	UL NFC DIN	CSA
Wire size mm ² / AWG	Screw clamp	Solid wire	0.2 - 4	
		Stranded wire	0.22 - 2.5	
Voltage	V	400		
Current	A	24		
Rated wire size	mm ² / AWG	2.5 mm ²		
Wire stripping length	mm / inches	10 mm / .39"		
Recommended torque (screw)	Nm / lb.in	0.4 - 0.6 Nm / 3.5 - 5.3 lb.in		

Selection

Description	Type	Order P/N	Packaging
Block for neutral circuit blue	<input type="checkbox"/> MA 2,5/5.NT	0125 487.06	50

M 4/6.NT- 4 mm² block - 6 mm .236" spacing

Characteristics

		IEC	UL NFC DIN	CSA
Wire size mm ² / AWG	Screw clamp	Solid wire	0.2 - 4	18-12 AWG
		Stranded wire	0.22 - 4	
Voltage	V	400		300
Current	A	32		25
Rated wire size	mm ² / AWG	4 mm ²		12 AWG
Wire stripping length	mm / inches	12 mm / .47"		
Recommended torque (screw)	Nm / lb.in	0.5 - 0.8 Nm / 4.4 - 7.1 lb.in		

Selection

Description	Type	Order P/N	Packaging
Block for neutral circuit blue	<input type="checkbox"/> M 4/6.NT	0125 117.02	50

M 6/8.NT- 6 mm² block - 8 mm .315" spacing

Characteristics

		IEC	UL NFC DIN	CSA
Wire size mm ² / AWG	Screw clamp	Solid wire	0.5 - 10	18-18 AWG
		Stranded wire	0.5 - 6	
Voltage	V	400		300
Current	A	41		50
Rated wire size	mm ² / AWG	6 mm ²		8 AWG
Wire stripping length	mm / inches	12 mm / .47"		
Recommended torque (screw)	Nm / lb.in	0.8 - 1 Nm / 7.1 - 8.9 lb.in		

Selection

Description	Type	Order P/N	Packaging
Block for neutral circuit blue	<input type="checkbox"/> M 6/8.NT	0125 119.14	50

Accessories

Description	Type	Order P/N	Packaging	
End stop	BAM2	9.9 mm	0206 351.16	50
End section	blue <input type="checkbox"/> FEM6	2.8 mm	0128 368.10	20
Busbar	BO3	1000x10x3 mm	0164 406.24	1
Busbar lock	blue <input type="checkbox"/> VRB3		0128 035.16	10
Screw clamp for busbar	SFB1 ①		0163 860.05	50
	SFB2 ②		0168 956.06	50

① SFB1 : 0.5 to 35 mm² 18 to 2 AWG H= 7 mm/.28"

② SFB2 : 16 to 35 mm² 6 to 2 AWG H= 3 mm/.12"

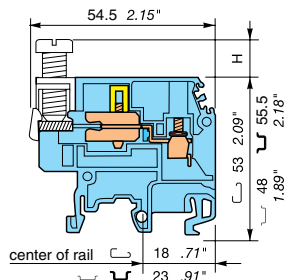

MA 2,5/5.NT

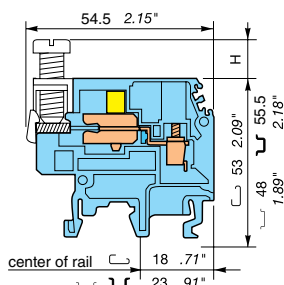

M 4/6.NT

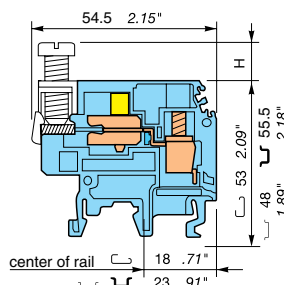

M 6/8.NT

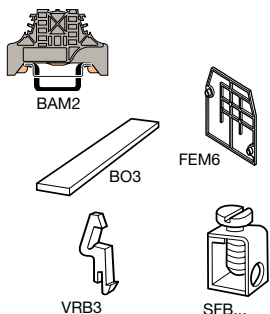

Interruptible terminal blocks for neutral circuit

Screw clamp, DIN 1 - 3



M 10/10.NT- 10 mm² block - 10 mm .394" spacing

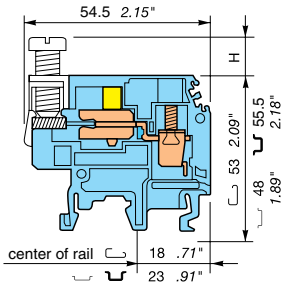

M 10/10.NT

Characteristics

		IEC	UL NFC DIN	CSA
Wire size mm ² / AWG	Screw clamp	Solid wire	0.5 - 16	18-6 AWG
		Stranded wire	0.5 - 10	
Voltage	V	400		300
Current	A	57		75
Rated wire size	mm ² / AWG	10 mm ²		6 AWG
Wire stripping length	mm / inches	12 mm / .47"		
Recommended torque (screw)	Nm / lb.in	1.2 - 1.4 Nm / 10.6 - 12.3 lb.in		

Selection

Description	Type	Order P/N	Packaging
Block for neutral circuit blue 	M 10/10.NT	0125 121.06	50

M 16/12.NT1- 16 mm² block - 12 mm .473" spacing

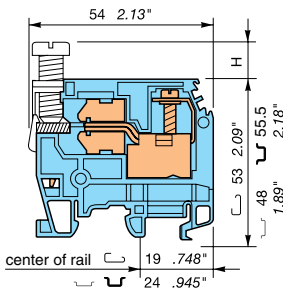

M 16/12.NT1

Characteristics

		IEC	UL NFC DIN	CSA
Wire size mm ² / AWG	Screw clamp	Solid wire	2.5 - 25	
		Stranded wire	2.5 - 16	
Voltage	V	400		
Current	A	76		
Rated wire size	mm ² / AWG	16 mm ²		
Wire stripping length	mm / inches	14 mm / .51"		
Recommended torque (screw)	Nm / lb.in	1.2 - 1.4 Nm / 10.6 - 12.3 lb.in		

Selection

Description	Type	Order P/N	Packaging
Block for neutral circuit blue 	M 16/12.NT1	0125 593.00	50

M 35/16.NT- 35 mm² block - 16 mm .669" spacing

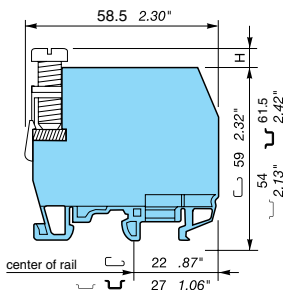

M 35/16.NT

Characteristics

		IEC	UL NFC DIN	CSA
Wire size mm ² / AWG	Screw clamp	Solid wire	10 - 50	
		Stranded wire	10 - 35	
Voltage	V	400		
Current	A	125		
Rated wire size	mm ² / AWG	35 mm ²		
Wire stripping length	mm / inches	17 mm / .67"		
Recommended torque (screw)	Nm / lb.in	2.8 - 3 Nm / 24.6 - 26.1 lb.in		

Selection

Description	Type	Order P/N	Packaging
Block for neutral circuit blue 	M 35/16.NT	0125 358.03	20

Accessories

Description	Type	Order P/N	Packaging	
End stop	BAM2	9.9 mm	0206 351.16	50
End section	blue  FEM6 ①	2.8 mm	0128 368.10	20
Busbar	BO3	1000x10x3 mm	0164 406.24	1
Busbar lock	blue  VRB3		0128 035.16	10
Screw clamp for busbar	SFB1 ②		0163 860.05	50
	SFB2 ③		0168 956.06	50

① Except for M 35/16 NT (closed block)
 ② SFB1 : 0.5 to 35 mm² 18 to 2 AWG H= 7 mm/.28"
 ③ SFB2 : 16 to 35 mm² 6 to 2 AWG H= 3 mm/.12"

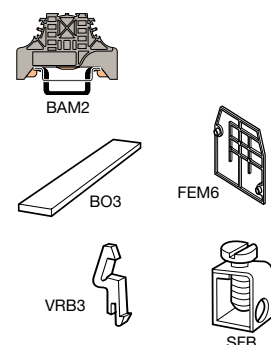

Distribution: phase, ground terminal blocks

Screw clamp, DIN 1-3

MB 4/6... - 4 mm² blocks - 6 mm .238" spacing (each)

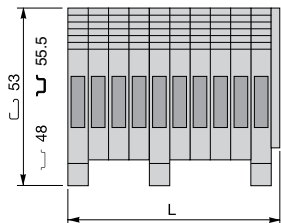

MB 4/6.L....

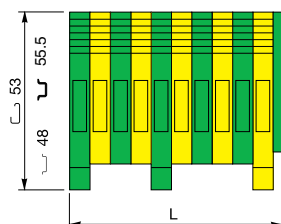

MB 4/6.P....

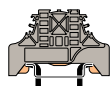

BAM2

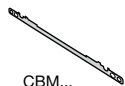

CBM...

Characteristics

Wire size mm ² / AWG	Solid Stranded	IEC NFC DIN	UL	CSA
		0.2 - 4 0.22 - 4	22-10 AWG	22-12 AWG
Voltage	V	800	600	600
Current	A	32	20	25
Short circuit current	A / s	300A/1s		
Rated wire size	mm ² / AWG	4 mm ²	10 AWG	10 AWG
Wire stripping length	mm / inches	9.5 mm / .37"		
Recommended torque	Nm / lb.in	0.5-0.8 Nm / 4.5-7.1 lb.in		

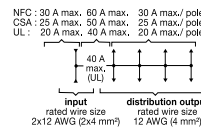

Selection

Description	Type	Order P/N	Packaging
Standard block grey	<input type="checkbox"/> MB 4/6.L2	0115 406.13	25
Standard block grey	<input type="checkbox"/> MB 4/6.L3	0115 407.14	5
Standard block grey	<input type="checkbox"/> MB 4/6.L4	0115 408.25	5
Standard block grey	<input type="checkbox"/> MB 4/6.L5	0115 409.26	5
Standard block grey	<input type="checkbox"/> MB 4/6.L6	0115 410.12	1
Standard block grey	<input type="checkbox"/> MB 4/6.L8	0115 411.07	1
Standard block grey	<input type="checkbox"/> MB 4/6.L10	0115 412.00	1
Ground block yellow body/ green marking (without rail contact)	<input type="checkbox"/> MB 4/6.P2	0165 420.26	25
Ground block yellow body/ green marking (without rail contact)	<input type="checkbox"/> MB 4/6.P3	0165 421.13	5
Ground block yellow body/ green marking (without rail contact)	<input type="checkbox"/> MB 4/6.P4	0165 422.14	5
Ground block yellow body/ green marking (without rail contact)	<input type="checkbox"/> MB 4/6.P5	0165 423.15	5
Ground block yellow body/ green marking (without rail contact)	<input type="checkbox"/> MB 4/6.P6	0165 424.16	1
Ground block yellow body/ green marking (without rail contact)	<input type="checkbox"/> MB 4/6.P8	0165 425.17	1
Ground block yellow body/ green marking (without rail contact)	<input type="checkbox"/> MB 4/6.P10	0165 426.10	1

Accessories

End stop	BAM2 9.9 mm	0206 351.16	50
Shield connector	CBM5 0.5 mm	0178 745.14	50
	CBM8 0.8 mm	0178 746.15	50

Distribution: phase, ground terminal blocks

Screw clamp, 𐀀 𐀀 DIN 1-3



MB 6/8... - 6 mm² blocks - 8 mm .315" spacing (each)

Characteristics

Wire size mm ² / AWG	Solid Stranded	IEC	UL	CSA
		NFC DIN		
		0.5 - 10 0.5 - 6	22-8 AWG	20-8 AWG
Voltage	V	800	600	600
Current	A	41	50	35
Short circuit current	A / s	720A/1s		
Rated wire size	mm ² / AWG	6 mm ²	8 AWG	8 AWG
Wire stripping length	mm / inches		12 mm / .47"	
Recommended torque	Nm / lb.in		0.8-1 Nm / 7.1-8.9 lb.in	

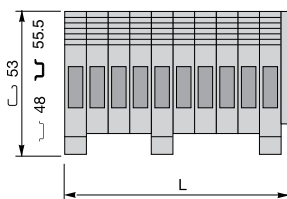
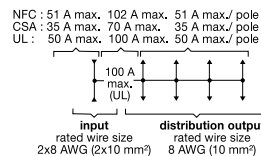

MB 6/8.L....

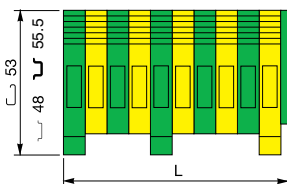

MB 6/8.P....

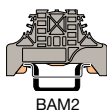

BAM2

Selection

Description	Type	Order P/N	Packaging	
Standard block grey	<input type="checkbox"/>	MB 6/8.L2	0115 413.01	25
Standard block grey	<input type="checkbox"/>	MB 6/8.L3	0115 414.02	5
Standard block grey	<input type="checkbox"/>	MB 6/8.L4	0115 415.03	5
Standard block grey	<input type="checkbox"/>	MB 6/8.L5	0115 416.04	5
Standard block grey	<input type="checkbox"/>	MB 6/8.L6	0115 417.05	1
Standard block grey	<input type="checkbox"/>	MB 6/8.L8	0115 418.16	1
Standard block grey	<input type="checkbox"/>	MB 6/8.L10	0115 419.17	1
Ground block yellow body/ green marking (without rail contact)	<input type="checkbox"/>	MB 6/8.P2	0165 427.11	25
Ground block yellow body/ green marking (without rail contact)	<input type="checkbox"/>	MB 6/8.P3	0165 428.22	5
Ground block yellow body/ green marking (without rail contact)	<input type="checkbox"/>	MB 6/8.P4	0165 429.23	5
Ground block yellow body/ green marking (without rail contact)	<input type="checkbox"/>	MB 6/8.P5	0165 430.20	5
Ground block yellow body/ green marking (without rail contact)	<input type="checkbox"/>	MB 6/8.P6	0165 431.15	1
Ground block yellow body/ green marking (without rail contact)	<input type="checkbox"/>	MB 6/8.P8	0165 432.16	1
Ground block yellow body/ green marking (without rail contact)	<input type="checkbox"/>	MB 6/8.P10	0165 433.17	1

Accessories

End stop	BAM2 9.9 mm	0206 351.16	50
----------	-------------	-------------	----

Distribution: phase, ground terminal blocks

Screw clamp, DIN 1-3

MB 10/10... - 10 mm² blocks - 10 mm .394" spacing (each)

Characteristics

		IEC NFC DIN	UL	CSA
Wire size mm ² / AWG	Solid	0.5 - 16	22-6 AWG	18-6 AWG
	Stranded	0.5 - 10		
Voltage	V	800	600	600
Current	A	63	65	50
Short circuit current	A / s	1200A/1s		
Rated wire size	mm ² / AWG	10 mm ²	6 AWG	6 AWG
Wire stripping length	mm / inches	12 mm / .47"		
Recommended torque	Nm / lb.in	1.2-1.4 Nm / 10.6-12.3 lb.in		

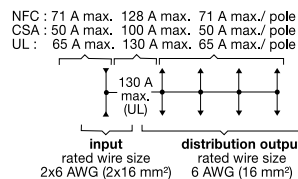

Selection

Description	Type	Order P/N	Packaging
Standard block grey	<input type="checkbox"/>	MB 10/10.L2	5
Standard block grey	<input type="checkbox"/>	MB 10/10.L3	5
Standard block grey	<input type="checkbox"/>	MB 10/10.L4	5
Standard block grey	<input type="checkbox"/>	MB 10/10.L5	5
Standard block grey	<input type="checkbox"/>	MB 10/10.L6	1
Standard block grey	<input type="checkbox"/>	MB 10/10.L8	1
Standard block grey	<input type="checkbox"/>	MB 10/10.L10	1
Ground block yellow body/ green marking (without rail contact)	<input type="checkbox"/>	MB 10/10.P2	5
Ground block yellow body/ green marking (without rail contact)	<input type="checkbox"/>	MB 10/10.P3	5
Ground block yellow body/ green marking (without rail contact)	<input type="checkbox"/>	MB 10/10.P4	5
Ground block yellow body/ green marking (without rail contact)	<input type="checkbox"/>	MB 10/10.P5	5
Ground block yellow body/ green marking (without rail contact)	<input type="checkbox"/>	MB 10/10.P6	1
Ground block yellow body/ green marking (without rail contact)	<input type="checkbox"/>	MB 10/10.P8	1
Ground block yellow body/ green marking (without rail contact)	<input type="checkbox"/>	MB 10/10.P10	1

Accessories

End stop	BAM2	9.9 mm	0206 351.16	50
----------	------	--------	-------------	----

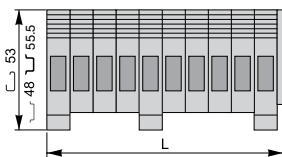

MB 10/10.L....

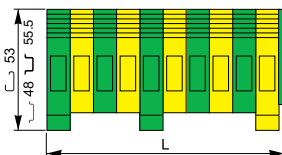

MB 10/10.P....

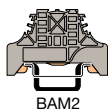

BAM2

Distribution blocks, single pole

Type BRU

Screw clamp, DIN 3

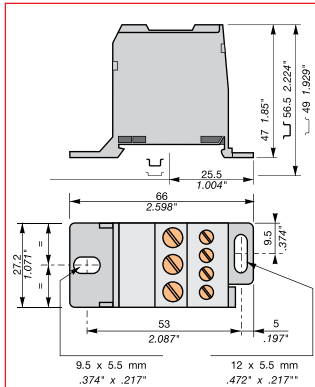

BRU 80 A

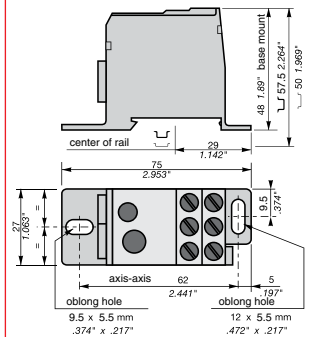

BRU 125 A

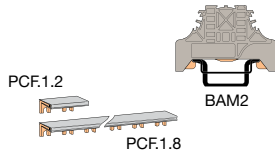

BRU 80 A

Characteristics

Wire size mm ² / AWG	Solid Stranded	IEC	UL	CSA
		NFC DIN		
		0.5 - 16	22-6 AWG	18-6 AWG
		0.5 - 10		
Voltage	V	600	600	600
Current	A	80	80	80
Rated wire size	mm ² / AWG	3x16 mm ²	3x4 AWG	3x4 AWG
Inputs		6-16mm ²	8-4 AWG	—
Outputs (4)		2.5-16mm ²	14-10 AWG	—
Outputs (2) with ferrules		2.5-16mm ²	8-4 AWG	—
Recommended torque	Nm / lb.in	0.8 Nm / 7 lb.in		

Selection

Description	Type	Order P/N	Packaging Weight kg
Grey body	<input type="checkbox"/> BRU 80 A	0356 208.25	1 0.137

BRU 125 A - 35 mm² block - 27 mm 1.063" spacing

Characteristics

Rated voltage	V	IEC	UL / CSA
		NFC DIN	
Rated current	A	125	125
Inputs : left input wire size	mm ² /AWG	10-35	8-2 AWG
right input wire size		6-16	10- 6 AWG
Recommended torque	Nm / lb.in	3.5	31 lb.in
Recommended torque wrench		Allen key/4 mm	
Outputs : with ferrules	mm ² /AWG	4x2.5 to 16	14 AWG to 6 AWG
without ferrules		6x2.5 to 16	14 AWG to 6 AWG
Recommended torque	Nm / lb.in	2 Nm	17.6 lb.in
Screwdriver		Posidriv Z2 or flat	

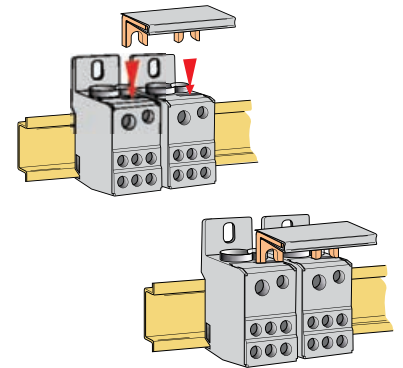

Selection

Description	Type	Order P/N	Packaging Weight kg
Grey body	<input type="checkbox"/> BRU 125 A	0356 204.11	1 0.137

Accessories

End stop	BAM2 9.9 mm	0206 351.16	50
Jumper bar	PCF.1.2	0356 205.12 ①	1
	PCF.1.8	0356 206.13 ①	1

① For BRU 125A only.

Screw clamp

Distribution blocks, single pole

Type BRU

Screw clamp, \mathcal{L} DIN 3

BRU 160 A - 70 mm² block - 35.2 mm 1.388" spacing

Characteristics

		IEC NFC DIN	UL / CSA
Rated voltage	V	600	600
Rated current	A	160	160
Inputs (maximum wire size)		10-70	8-00 AWG
left input wire size	mm ² /AWG		
right input wire size	mm ² /AWG		
Recommended torque	Nm / lb.in	4	35 lb.in
Recommended torque wrench		Allen key/5 mm	
Outputs with ferrules	mm ² /AWG	6x2.5 to 16	14 AWG to 6 AWG
without ferrules	mm ² /AWG		
Recommended torque	Nm / lb.in	2 Nm	17.6 lb.in

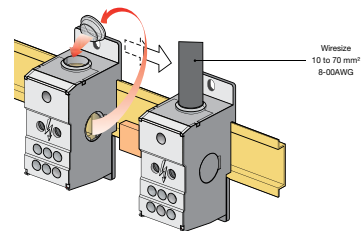

Selection

Description	Type	Order P/N	Packaging Weight kg
Grey body	<input type="checkbox"/> BRU 160 A	0356 200.21	1 0.234

Accessories

End stop	BAM2	9.9 mm	0206 351.16	50
Busbar	BO 16/5	2 poles	0356 201.16	1
	BO 16/5	3 poles	0356 202.17	1
	BO 16/5	4 poles	0356 203.10	1

BRU 250 A - 120 mm² blocks - 44.5 mm 1.752" spacing

Characteristics

		IEC NFC DIN	UL / CSA
Rated voltage	V	600	600
Rated current	A	250	230
Inputs mini		35 - 120	2-0000 AWG
max. wire size	mm ² /AWG		
Recommended torque	Nm / lb.in	19 Nm	170 lb.in
Recommended torque wrench		Allen key/6 mm	
Outputs with ferrules	mm ² /AWG	2x2.5 to 25	2x14 AWG to 4 AWG
without ferrules	mm ² /AWG	2x2.5 to 35	2x14 AWG to 2 AWG
Recommended torque	Nm / lb.in	3.5 Nm	31 lb.in
Wire size with/without ferrule	mm ² /AWG	5x2.5 to 16	5x14 AWG to 6 AWG
Recommended torque	Nm / lb.in	2 Nm	18 lb.in
Wire size with/without ferrule	mm ² /AWG	4x2.5 to 10	4x14AWG to 8 AWG
Recommended torque	Nm / lb.in	2 Nm	18 lb.in

Selection

Description	Type	Order P/N	Packaging Weight kg
Grey body	<input type="checkbox"/> BRU 250 A	0179 657.15	1 0.450
Black body	<input checked="" type="checkbox"/> BRU 250 ALU	0356 207.14	1 0.220

Accessories

End stop	BAM2	9.9 mm	0206 351.16	50
----------	------	--------	-------------	----

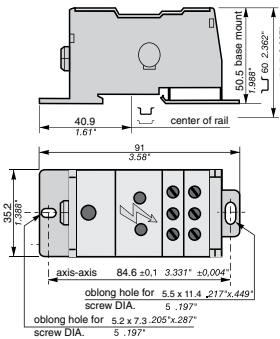

BRU 160 A

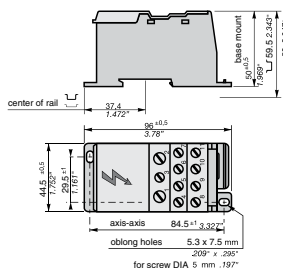
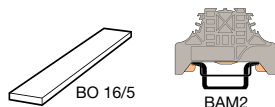

BAM2

Distribution blocks, single pole

Type BRU

Screw clamp, DIN 3



BRU 400 A - 185 mm² block - 44.5 mm 1.752" spacing

Characteristics

		IEC	
		NFC	DIN
Rated voltage	V	600	600
Rated current	A	400	310
Inputs mini			
max. wire size	mm ² /AWG	95 - 185	000 AWG-350 MCM
Recommended torque	Nm /lb.in	25 Nm	230 lb.in
Recommended torque wrench		Allen key/8 mm	
Outputs with ferrules			
without ferrules	mm ² /AWG	2x2.5 to 25	2x14 AWG to 4 AWG
Recommended torque	Nm / lb.in	3.5 Nm	31 lb.in
Wire size with/without ferrule	mm ² /AWG	5x2.5 to 16	5x14 AWG to 6 AWG
Recommended torque	Nm / lb.in	2 Nm	18 lb.in
Wire size with/without ferrule	mm ² /AWG	4x2.5 to 10	4x14 AWG to 8 AWG
Recommended torque	Nm / lb.in	2 Nm	18 lb.in

Selection

Description	Type	Order P/N	Packaging Weight kg
Grey body <input type="checkbox"/>	BRU 400 A	0179 650.22	1 0.450

Accessories

End stop	BAM2 9.9 mm	0206 351.16	50
----------	-------------	-------------	----

Distribution blocks, three pole

Type BRT

Screw clamp, \sqcup DIN 3

BRT 115 A

Characteristics

		IEC NFC	DIN	UL	CSA
Wire size mm ² / AWG	Solid	0.5 - 16 0.5 - 16		Input 8 to 2 AWG (per pole) Output 14 to 4 AWG (per pole)	8 to 2 AWG (per pole) 14 to 4 AWG (per pole)
Voltage	V	690		600	600
Current	A	125		115	115
Rated wire size	mm ² / AWG	10-35 mm ²		—	—
Recommended torque input	Nm / lb.in			6 Nm / 53.1 lb.in.	
Recommended torque output	Nm / lb.in			3 Nm / 26.53 lb. in.	

Selection

Description	Type	Order P/N	Packaging	Weight kg
Grey body	<input type="checkbox"/> BRT 115 A	0356 209.26	1	0.137

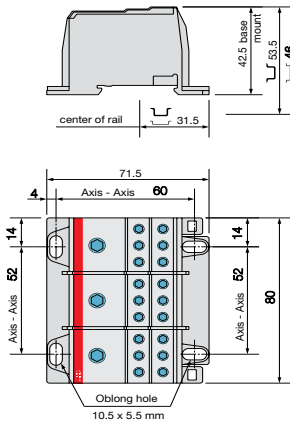

BRT 115 A

BRT 175 A

Characteristics

		IEC NFC	DIN	UL	CSA
Wire size mm ² / AWG	Solid	0.5 - 16 0.5 - 16		Input 6 to 2/0 AWG (per pole) Output 14 to 4 AWG (per pole)	6 to 2/0 AWG (per pole) 14 to 4 AWG (per pole)
Voltage	V	690		600	600
Current	A	125		175	175
Rated wire size	mm ² / AWG	10-35 mm ²		—	—
Recommended torque input	Nm / lb.in			6 Nm / 53.1 lb.in.	
Recommended torque output	Nm / lb.in			3 Nm / 26.53 lb. in.	

Selection

Description	Type	Order P/N	Packaging	Weight kg
Grey body	<input type="checkbox"/> BRT 175 A	0356 210.21	1	0.137

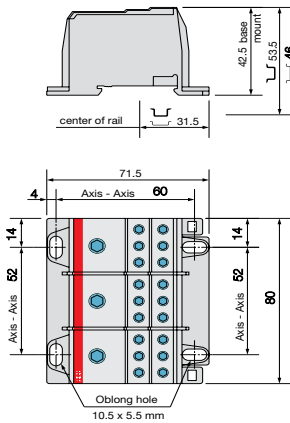

BRT 175 A

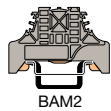

BAM2

Accessories

End stop	BAM2 9.9 mm	0206 351.16	50
----------	-------------	-------------	----

Distribution blocks, four pole

Type BRT

Screw clamp, \perp DIN 3



BRT 80 A - 16 mm² block - 48 mm 1.89" spacing

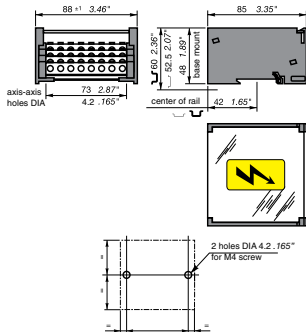

BRT 80 A

Characteristics

		IEC NFC DIN	UL	CSA
Rated voltage	V	600	600	
Rated current	A	80	65	
Short circuit current	A/S	26.1kA/3kA1s	21.6 KA	
Inputs	mm ² /AWG	16 mm ²	6 AWG	
Outputs (with ferrules)		8x10 mm ²	8x8 AWG	

Selection

Description	Type	Order P/N	Packaging Weight kg
Grey body	<input type="checkbox"/> BRT 80 A	0179 534.22	1 0.210

BRT 125 A - 35 mm² block - 48 mm 1.89" spacing

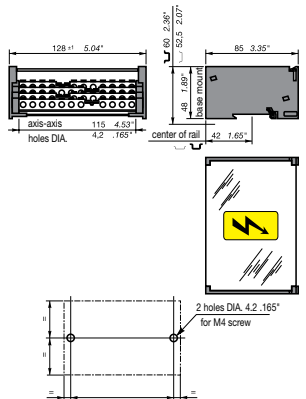

BRT 125 A

Characteristics

		IEC NFC DIN	UL	CSA
Rated voltage	V	600	600	
Rated current	A	125	65	
Short circuit current	A/S	29.6kA/4.2kA1s	29.6 KA	
Inputs	mm ² /AWG	35 mm ²	4-2 AWG	
Outputs (with ferrules)		4x16 mm ² 7x10mm ²	4x6 AWG 7x8 AWG	

Selection

Description	Type	Order P/N	Packaging Weight kg
Grey body	<input type="checkbox"/> BRT 125 A	0179 535.23	1 0.300

BRT 160 A - 50 mm² block - 50 mm 1.97" spacing

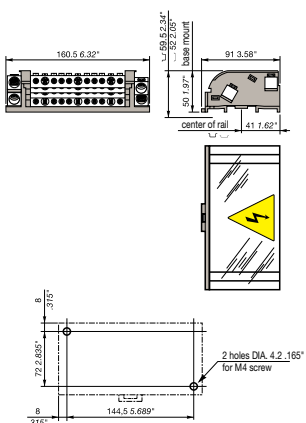

BRT 160 A

Characteristics

		IEC NFC DIN	UL	CSA
Rated voltage	V	600	600	600
Rated current	A	160	160	160
Short circuit current	A/S	20kA/6.2kA1s		
Inputs	mm ² /AWG	10 to 50	6 to 0 AWG	6 to 0 AWG
Outputs (with ferrules)		3x6 to 35 8x2.5 to 16	3x10 to 2 AWG 8x14 to 6AWG	3x10 to 2 AWG 8x14 to 6 AWG

Selection

Description	Type	Order P/N	Packaging Weight kg
Grey body	<input type="checkbox"/> BRT 160 A	0179 892.22	1 0.380

Accessories

End stop	BAM2 9.9 mm	0206 351.16	50
----------	-------------	-------------	----

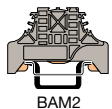

Heavy duty switch terminal blocks with blade

Screw clamp, DIN 1-3

MA 2,5/5.SNB - 2.5 mm² blocks - 5 mm .200" spacing

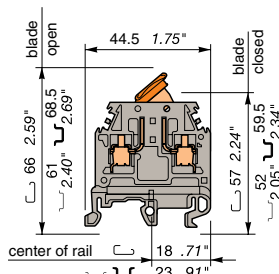

MA 2,5/5.SNB

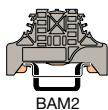

BAM2



FEM6

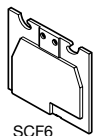

SCF6

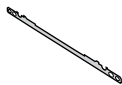



CBM...

Characteristics

		IEC NFC DIN	UL	CSA
Wire size mm ² / AWG	Solid	0.5 - 4	22-12 AWG	22-12 AWG
	Stranded	0.5 - 2.5		
Voltage	V	320	150	150
Current	A	10	10	10
Rated wire size	mm ² / AWG	2.5 mm ²	12 AWG	12 AWG
Wire stripping length	mm / inches	10 mm / .39"		
Recommended torque	Nm / lb.in	0.4-0.6 Nm / 3.5-5.3 lb.in		

Selection

Description	Type	Order P/N	Packaging	
Standard block grey/orange		MA 2,5/5.SNB	0115 699.20	50
Standard block grey/orange + Test Ø 2mm		MA 2,5/5.SNB T1	0115 700.05	50

Accessories

End stop		BAM2 9.9 mm	0206 351.16	50
End section	grey	 FEM6 2.8 mm	0118 368.16	20
	orange	 FEM6 2.8 mm	0103 126.16	20
Separator end section	grey	 SCF6 3 mm	0118 707.03	20
Shield connector		CBM5 0.5 mm	0178 745.14	50
		CBM8 0.8 mm	0178 746.15	50

MA 2,5/5.SNBTA - 2.5 mm² blocks - 5 mm .200" spacing

Characteristics

		IEC NFC DIN	UL	CSA
Wire size mm ² / AWG	Solid	0.5 - 4	22-12 AWG	22-12 AWG
	Stranded	0.5 - 4		
Voltage	V	320	600	150
Current	A	10	15	10
Rated wire size	mm ² / AWG	2.5 mm ²	12 AWG	12 AWG
Wire stripping length	mm / inches	10 mm / .39"		
Recommended torque	Nm / lb.in	0.4-0.6 Nm / 3.5-5.3 lb.in		

Selection

Description	Type	Order P/N	Packaging	
Grey / Grey		MA 2,5/5.SNBTA	0115 505.16	50

Heavy duty switch terminal blocks with blade

Screw clamp, DIN 1-3



M 4/6.SNB - 4 mm² blocks - 6 mm .238" spacing

Characteristics

		IEC NFC DIN	UL	CSA
Wire size mm ² / AWG	Solid	0.5 - 4	22-10 AWG	20-12 AWG
	Stranded	0.5 - 2.5		
Voltage	V	400	300	300
Current	A	20	10	10
Rated wire size	mm ² / AWG	4 mm ²	10 AWG	12 AWG
Wire stripping length	mm / inches	9.5 mm / .37"		
Recommended torque	Nm / lb.in	0.5-0.6 Nm / 4.4-5.3 lb.in		

Selection

Description	Type	Order P/N	Packaging
Standard block grey / orange 	M 4/6.SNB	0115 986.00	50
Standard block grey / orange + Test Ø 2mm 	M 4/6.SNBT	0115 987.01	50

Accessories

End stop	BAM2 9.9 mm	0206 351.16	50
End section grey 	FEM62 3 mm	0114 994.07	20
Shield connector	CBM5 0.5 mm	0178 745.14	50
	CBM8 0.8 mm	0178 746.15	50

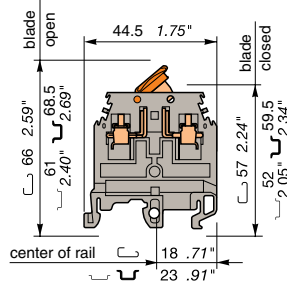

M 4/6.SNB

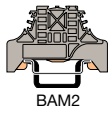

BAM2



FEM62



CBM...

M 4,6 SNBT... - 4 mm² blocks - 6 mm .238" spacing

Characteristics

		IEC NFC DIN	UL	CSA
Wire size mm ² / AWG	Solid	0.5 - 4	22-10 AWG	—
	Stranded	0.5 - 4		
Voltage	V	320	300	—
Current	A	20	10	—
Rated wire size	mm ² / AWG	4 mm ² A4	10 AWG	—
Wire stripping length	mm / inches	9.5 mm / .374"		
Recommended torque	Nm / lb.in	0.5-0.6 Nm / 4.4-5.3 lb.in		

Selection

Description	Type	Order P/N	Packaging
Grey / Orange	M 4/6.SNBT.23	0206 538.02	50

Accessories

End stop	BAM2 9.9 mm	0206 351.16	50
End section grey 	FEM62 3 mm	0114 994.07	20
Shield connector	CBM5 0.5 mm	0178 745.14	50
	CBM8 0.8 mm	0178 746.15	50

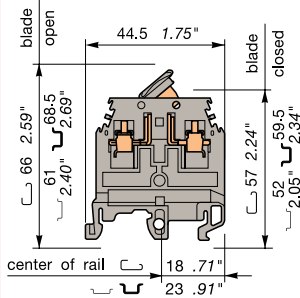

M 4/6.SNBT...

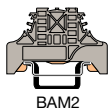

BAM2



FEM62



CBM...

Heavy duty switch terminal blocks

Screw clamp, DIN 1-3

M 6/8.SNB - 6 mm² blocks - 8 mm .315" spacing - blade switching

Characteristics

		IEC NFC	DIN	UL	CSA
Wire size mm ² / AWG	Solid	0.5 - 10		22-8 AWG	20-12 AWG
	Stranded	0.5 - 6			
Voltage	V	400		300	300
Current	A	15		20	10
Rated wire size	mm ² / AWG	6 mm ²		10 AWG	12 AWG
Wire stripping length	mm / inches	12 mm / .47"			
Recommended torque	Nm / lb.in	0.8-1 Nm / 7.1-8.9 lb.in			

Selection

Description	Type	Order P/N	Packaging
Standard block grey	<input type="checkbox"/> M 6/8.SNB	0115 688.25	50

Accessories

End stop		BAM2 9.9 mm	0206 351.16	50
End section	grey	<input type="checkbox"/> FEM8 3 mm	0113 373.26	20
	orange	<input type="checkbox"/> FEM8 3 mm	0103 230.02	20
Separator end section	grey	<input type="checkbox"/> SCFM6 3 mm	0114 825.05	20

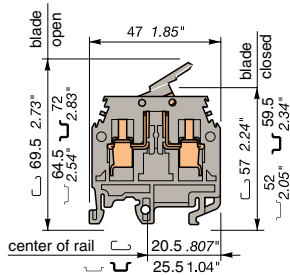

M 6/8.SNB

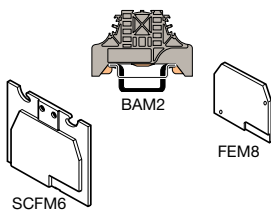

M 6/8.STP - 6 mm² blocks - 8 mm .315" spacing - push-turn knob switching

Characteristics

		IEC NFC	DIN	UL	CSA
Wire size mm ² / AWG	Solid	0.5 - 10		22-8 AWG	8 AWG
	Stranded	0.5 - 6			
Voltage	V	500		600	600
Current	A	15		40	15
Rated wire size	mm ² / AWG	6 mm ²		8 AWG	8 AWG
Wire stripping length	mm / inches	11 mm / .433"			
Recommended torque	Nm / lb.in	0.8-1 Nm / 7.1-8.9 lb.in			

Selection

Description	Type	Order P/N	Packaging
Standard block grey	<input type="checkbox"/> M 6/8.STP	0115 277.20	25
Bloc with Ø4mm test socket	<input type="checkbox"/> M 6/8.STP 1	0115 529.15	25

Accessories

End section		BAM2 9.9 mm	0206 351.16	50
Separator end section	grey	<input type="checkbox"/> FEMT1 2.8 mm	0113 137.02	50

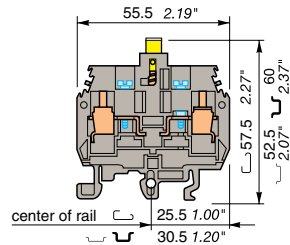

M 6/8.STP

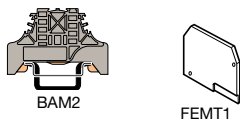

Heavy duty switch and fuse holder terminal blocks

Double-deck

Screw clamp, DIN 1 - DIN 3

Screw clamp

M 4/6.D2.SNBT - 4 mm² blocks - 6 mm .238" spacing - blade switch

Characteristics

		IEC NFC DIN	UL	CSA
Wire size mm ² / AWG	Solid	0.5 - 4	24-12 AWG	22-12 AWG
	Stranded	0.5 - 4		
Voltage	V	400	300	300
Current	A	10	15	15
Rated wire size	mm ² / AWG	4 mm ²	12 AWG	12 AWG
Wire stripping length	mm / inches	9.5 mm / .374"		
Recommended torque	Nm / lb.in	0.5-0.6 Nm / 4.4-5.3 lb.in		

Selection

Description	Type	Order P/N	Packaging
Standard block grey	<input type="checkbox"/> M 4/6.D2.SNBT	0115 561.15	50

Accessories

End stop	BADH	12 mm	0116 900.27	50	
	BAMH	9.1 mm	0114 836.00	50	
End section	Grey <input type="checkbox"/>	FEMS6D	1.5 mm	0116 591.05	20
Assembled jumper bar (with IP20 protection)	2 poles	BJMI6D	32 A ①	0179 668.20	10
	3 poles	BJMI6D	32 A ①	0179 669.21	10
	4 poles	BJMI6D	32 A ①	0179 670.26	10
	5 poles	BJMI6D	32 A ①	0179 671.13	10
	10 poles	BJMI6D	32 A ①	0179 672.14	10
Shield connector		CBD2S		0178 408.14	50

M 4/8.D2.SF - for fuses 5x20 mm .197x.787 in. and 5x25 mm .197x.984 in. - 4 mm² blocks - 8 mm .315" spacing

Characteristics

		IEC NFC DIN	UL	CSA
Wire size mm ² / AWG	Solid	0.5 - 6	24-12 AWG	24-12 AWG
	Stranded	0.5 - 4		
Voltage	V	630 ②	300 ②	300 ②
Current	A	6.3	20	20
Rated wire size	mm ² / AWG	4 mm ²	12 AWG	12 AWG
Wire stripping length	mm / inches	9.5 mm / .37"		
Recommended torque	Nm / lb.in	0.5-0.8 Nm / 4.4-7.1 lb.in		

Selection

Description	Type	Order P/N	Packaging
Standard block grey	<input type="checkbox"/> M 4/8.D2.SF	0115 604.21	50
Standard block beige V0	<input type="checkbox"/> M 4/8.D2.SF.V0	0195 604.22	50

Accessories

End stop	BADH	12 mm	0116 900.27	50	
	BAMH	9.1 mm	0114 836.00	50	
End section	grey <input type="checkbox"/>	FEM8D2S	1.5 mm	0116 913.07	20
Assembled jumper bar (with IP20 protection)	2 poles	BJM8D	41 A ①	0168 520.05	10
	3 poles	BJM8D	41 A ①	0168 521.22	10
	4 poles	BJM8D	41 A ①	0168 522.23	10
	5 poles	BJM8D	41 A ①	0168 528.24	10
	10 poles	BJM8D	41 A ①	0168 974.00	10
Shield connector		CBD2S		0178 408.14	50

① Lower deck only.

② Insulation voltage of terminal block - operating voltage : according to fuse.

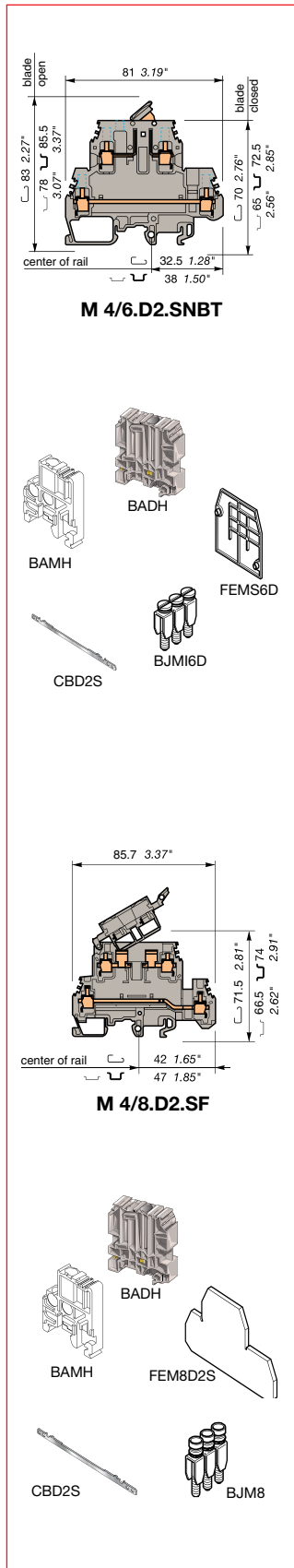

Fuse holder terminal blocks

5x20 mm .197x.787 in. and 5x25 mm .197x.984 in.
Screw clamp, C U DIN 1 - DIN3

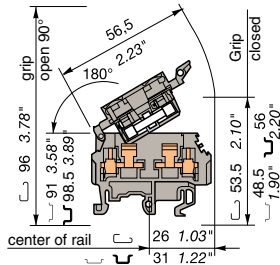

M 4/8.SF

M 4/8.SF- 4 mm² blocks - 8 mm .315" spacing

Characteristics

		IEC NFC	DIN	UL	CSA
Wire size mm ² / AWG	Solid	0.5 - 6		22-12 AWG	22-12 AWG
	Stranded	0.5 - 4			
Voltage	V	630 ①②		600 ①	250
Current	A	6.3		10	10
Rated wire size	mm ² / AWG	4 mm ²		12 AWG	12 AWG
Wire stripping length	mm / inches	9.5 mm / .37"			
Recommended torque	Nm / lb.in	0.5-0.8 Nm / 4.4-7.1 lb.in			

Selection

Description	Type	Order P/N	Packaging	
Standard block	grey <input type="checkbox"/>	M 4/8.SF	0115 657.25	50
Block with test socket Ø2 mm	grey <input type="checkbox"/>	M 4/8.SF	0115 662.22	50
Standard block	orange <input type="checkbox"/>	M 4/8.SF2	0105 135.11	50
Standard block	beige V0 <input type="checkbox"/>	M 4/8.SF.V0	0195 657.26	50

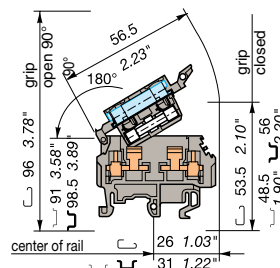

M 4/8.SFL

M 4/8.SFL - 4 mm² blocks - 8 mm .315" spacing

Characteristics

		IEC NFC	DIN	UL	CSA
Wire size mm ² / AWG	Solid	0.5 - 6		22-12 AWG	22-12 AWG
	Stranded	0.5 - 4			
Voltage	V	400		600	250
Current	A	6.3		10	10
Rated wire size	mm ² / AWG	4 mm ²		12 AWG	12 AWG
Wire stripping length	mm / inches	9.5 mm / .374"			
Recommended torque	Nm / lb.in	0.5-0.8 Nm / 4.4-7.7 lb.in			

Selection

Description	Type	Order P/N	Packaging	
Block with fusion indicator neon	grey <input type="checkbox"/>	M 4/8.SFL	0115 661.21	50
Block with fusion indicator 24V	grey <input type="checkbox"/>	M 4/8.SFD	0115 663.23	50

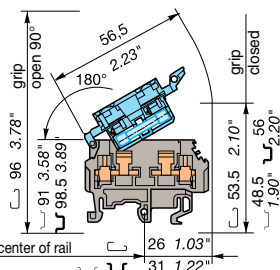

M 4/8.SN

M 4/8.SN - 4 mm² blocks - 8 mm .315" spacing

Characteristics

		IEC NFC	DIN	UL	CSA
Wire size mm ² / AWG	Solid	0.5 - 6		22-12 AWG	24-12 AWG
	Stranded	0.5 - 4			
Voltage	V	630 ①		600	250
Current	A	6.3		10	10
Rated wire size	mm ² / AWG	4 mm ²		12 AWG	12 AWG
Wire stripping length	mm / inches	9.5 mm / .37"			
Recommended torque	Nm / lb.in	0.5-0.8 Nm / 4.4-7.1 lb.in			

Selection

Description	Type	Order P/N	Packaging	
Standard block grey body/blue grip	<input type="checkbox"/>	M 4/8.SN	0115 659.07	50
Standard block beige body/blue V0 grip	<input type="checkbox"/>	M 4/8.SN.V0	0195 659.00	50

Accessories

End stop		BAM2 9.9 mm	0206 351.16	50
End section	grey <input type="checkbox"/>	FEM8S 1.5 mm	0116 951.15	20
	orange <input type="checkbox"/>	FEM8S 1.5 mm	0103 923.15	20

① Insulation voltage of terminal block - operating voltage : according to fuse.
② 400 V for block M 4/6.SFT

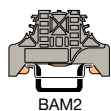

Fuse holder terminal blocks & heavy duty switch terminal block with contact control pull lever

Screw clamp, DIN 1-3

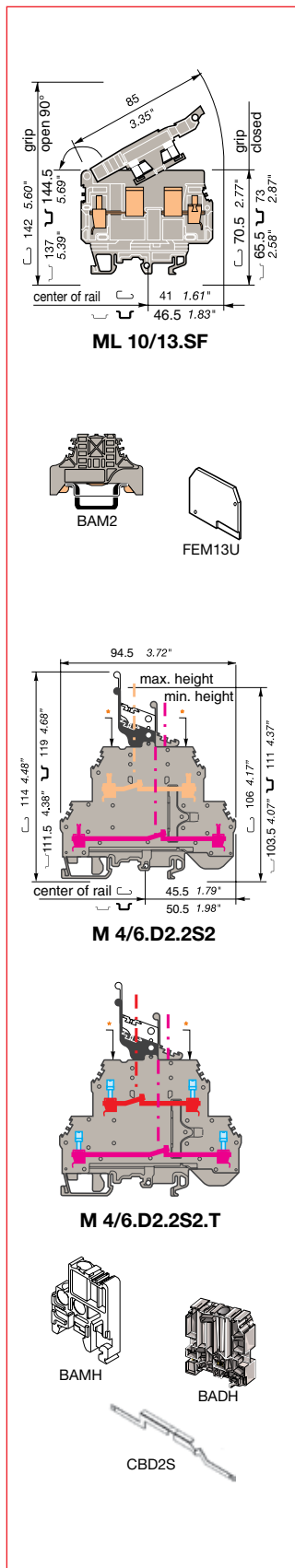

ML 10/13.SF - for fuses 6.35x25.4 mm ^{1/4}x1 in. and 6.35x32 mm ^{1/4}x1 ^{1/4} in. - 10 mm² blocks - 13 mm .512" spacing

Characteristics

Wire size mm ² / AWG	Solid Stranded	IEC	UL	CSA
		NFC DIN		
		0.5 - 16	22-10 AWG	22-8 AWG
Voltage	V	800(1)	600	600
Current	A	16	25	25
Rated wire size	mm ² / AWG	10 mm ²	10 AWG	8 AWG
Wire stripping length	mm / inches	12 mm / .472"		
Recommended torque	Nm / lb.in	1.2-1.4 Nm / 10.6-12.3 lb.in		

Selection

Description	Type	Order P/N	Packaging
Standard block	black V0 ■ ML 10/13.SF	0199 095.13	20

Accessories

End stop	BAM2	9.9 mm	0206 351.16	50
End section	black V0 ■ FEM13U	1.5 mm	0199 635.24	10

M 4/6.D2.2S2... - 4 mm² blocks - 6 mm .238" spacing

Characteristics

Wire size mm ² / AWG	Solid Stranded	IEC	UL	CSA
		NFC DIN		
		0.2 - 4	24-10 AWG	24-10 AWG
Voltage	V	500	300	300
Current	A	10	10	10
Rated wire size	mm ² / AWG	4 mm ²	10 AWG	10 AWG
Wire stripping length	mm / inches	9.5 mm / .374"		
Recommended torque	Nm / lb.in	0.5-0.8 Nm / 4.4-7.1 lb.in		

Selection

Description	Type	Order P/N	Packaging
Standard block grey	□ M 4/6.D2.2S2	0199 444.25	25
Block grey with 4 tests DIA. 2 mm	□ M 4/6.D2.2S2.T	0199 448.01	25

Accessories

End stop	BADH	12 mm	0116 900.27	50
	BAMH	9.1 mm	0114 836.00	50
Shield connector	CBD2S		0178 408.14	50

Screw clamp

Terminal blocks for test circuits with sliding bridge

Screw clamp, DIN 1 - 3

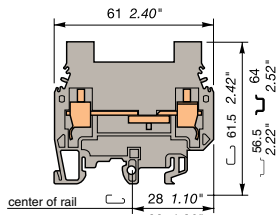

M 6/8.STA

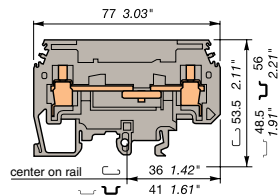

M 6/8.ST

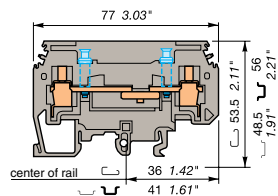

M 6/8.ST1

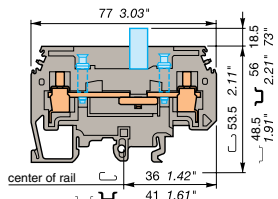

M 6/8.ST3

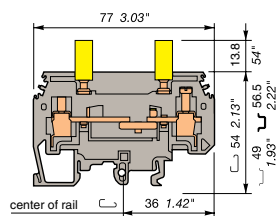

M 6/8.ST1.V2.IP20

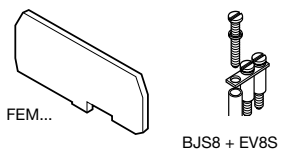
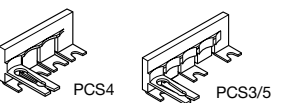
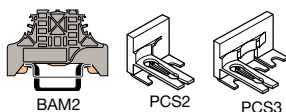

M 6/8.STA - 6 mm² blocks - 8 mm .315" spacing

Characteristics

		IEC	UL NFC DIN	CSA
Wire size mm ² / AWG	Solid	0.5 - 10	22-8 AWG	
	Stranded	0.5 - 6		
Voltage	V	500	600	
Current	A	30	30	
Rated wire size	mm ² / AWG	6 mm ²	8 AWG	
Wire stripping length	mm / inches	11 mm / .43"		
Recommended torque	Nm / lb.in	0.8-1 Nm / 7.1-8.9 lb.in		

M 6/8.ST... - 6 mm² blocks - 8 mm .315" spacing

Characteristics

		IEC	UL NFC DIN	CSA
Wire size mm ² / AWG	Solid wire	0.5 - 10		18 - 8 AWG
	Stranded wire	0.5 - 6		
Voltage	V	500V Gr.C		150
Current	A	30		30
Rated wire size	mm ² / AWG	6 mm ²		8 AWG
Wire stripping length	mm / inches	13 mm / .51"		
Recommended torque (screw)	Nm / lb.in	0.8 - 1 Nm / 7.1 - 8.9 lb.in		

Selection

Description	Type	Order P/N	Packaging
Block with Ø4mm test socket grey	<input type="checkbox"/> M 6/8.STA	0115 359.02	25
Standard block beige V0	<input type="checkbox"/> M 6/8.STA.V0	0195 359.03	25
Block with sliding grey	<input type="checkbox"/> M 6/8.ST	0115 236.17	25
Block with 2 sockets Ø4 grey	<input type="checkbox"/> M 6/8.ST1	0115 237.10	25
Block with sliding and 2 sockets Ø4 grey	<input type="checkbox"/> M 6/8.ST3	0115 239.22	25

M 6/8.ST1.V...IP20 - 6 mm² blocks - 8 mm .315" spacing

Characteristics

		IEC	UL NFC DIN	CSA
Wire size mm ² / AWG	Solid wire	0.5 - 10		
	Stranded wire	0.5 - 6		
Voltage	V	400		
Current	A	30		
Rated wire size	mm ² / AWG	6 mm ²		
Wire stripping length	mm / inches	13 mm / .51"		
Recommended torque (screw)	Nm / lb.in	0.8 - 1 Nm / 7.1 - 8.9 lb.in		

Selection

Description	Type	Order P/N	Packaging
Block standard grey V2	<input type="checkbox"/> M 6/8.ST1.V2.IP20	0115 971.10	25
Block standard beige V0	<input type="checkbox"/> M 6/8.ST1.V0.IP20	0195 639.24	25

Accessories

End stop		BAM2 9.9 mm	0206 351.16	50
End section	grey	<input type="checkbox"/> FEMSTA3 mm ③	0116 979.21	10
End section	grey	<input type="checkbox"/> FEMT4 3 mm ③	0114 778.05	20
End section	grey	<input type="checkbox"/> FEMT2 1 mm ②	0113 629.27	10
Sliding switch bridge	2 poles	PCS2 IP20 ①	0199 871.21	10
Sliding switch bridge	3 poles	PCS3 IP20 ①	0199 872.22	10
Sliding switch bridge	3 poles	PCS3/5 IP20 ①	0199 873.23	10
Sliding switch bridge	4 poles	PCS4 IP20 ①	0199 870.04	10
Jumper bar	15 poles	BJS8 ②	0174 788.04	10
not assembled	20 poles	BJS8 ②	0174 789.05	5
Post + screw + washer		EV8S ②	0168 401.03	20

① Only for M 6/8.ST1

② Only for M 6/8.ST

③ Only for M 6/8.ST1.V...IP20

Terminal blocks for metering circuits

Screw clamp, DIN 1 - DIN 3



M 4/6.ST- 4 mm² blocks - 6 mm .236" spacing

Characteristics

			IEC	UL NFC DIN	CSA
Wire size mm ² / AWG	Screw clamp	Solid wire	0.5 - 4	22-12 AWG	22-12 AWG
		Stranded wire	0.5 - 4		
Crimped (plug)		0.22 à 2.5 mm ² according to pin 24-12 AWG			
Voltage	V	500 Gr.C	300	150	
Current	A	5 ①	10	5	
Rated wire size	mm ² / AWG	4 mm ²	12 AWG	12 AWG	
Wire stripping length	mm / inches	9.5 mm / .374"			
Recommended torque (screw)	Nm / lb.in	0.5 - 0.8 Nm / 4.4 - 7.1 lb.in			

Selection

Description	Type	Order P/N	Packaging
Block standard tinned contact blade grey	<input type="checkbox"/> M 4/6.ST.Sn	0115 313.14	20

M 10/10.ST-Sn - 10 mm² blocks - 10 mm .394" spacing

Characteristics

			IEC	UL NFC DIN	CSA
Wire size mm ² / AWG	Screw clamp	Solid wire	0.5 - 16		20-8 AWG
		Stranded wire	0.5 - 10		
Voltage	V	500 Gr.C	300		
Current	A	15 ②	10		
Rated wire size	mm ² / AWG	10 mm ²	8 AWG		
Wire stripping length	mm / inches	12 mm / .472"			
Recommended torque (screw)	Nm / lb.in	1.2 - 1.4 Nm / 10.6 - 12.3 lb.in			

Selection

Description	Type	Order P/N	Packaging
Block standard V2 tinned contact blade grey	<input type="checkbox"/> M 10/10.ST-Sn	0115 539.17	20

Accessories

End stop		BAM2	9.9 mm	0206 351.16	50
End section	grey	<input type="checkbox"/> FEMT3	2.5 mm	0114 328.22	20
	grey	<input type="checkbox"/> FEMT5	2.5 mm	0116 781.13	20
Plug	red	<input checked="" type="checkbox"/> BNT1		0105 012.11	20
	red	<input checked="" type="checkbox"/> BNT1 V0		0199 135.17	20
	grey	<input type="checkbox"/> BNT2		0114 329.23	20
	beige	<input type="checkbox"/> BNT2 V0		0194 329.24	20
	green	<input type="checkbox"/> BNT3		0105 011.10	20
	green	<input type="checkbox"/> BNT3 V0		0199 136.10	20
Assembly key for plugs		CVABM		0183 436.05	10
		CVABM1 ③		0116 783.15	100
Crimped pins	24-20 AWG	0.22 to 0.5 mm ²	BRC	0174 558.05	10
	18 AWG	1 mm ²	BRC	0173 906.22	10
	16 AWG	1.5 mm ²	BRC	0173 907.23	10
	14 AWG	2.5 mm ²	BRC	0173 908.04	10
	12 AWG	4 mm ²	BRC	0174 601.01	10
Crimping tool for BRC		PSC		0173 181.13	1
Comb-type jumper bar	10 poles	PC61	35 A	0163 311.22	10
	10 poles	PC10	70 A ②	0163 315.26	10
IDC jumper		AD2.5	24 A	0114 205.20	50
Shield connector		CBM5	0.5 mm	0178 745.14	50
		CBM8	0.8 mm		50

① Maximum withstand current : 30 A - 1 second

② Maximum withstand current

③ Only for M10/10.ST-Sn

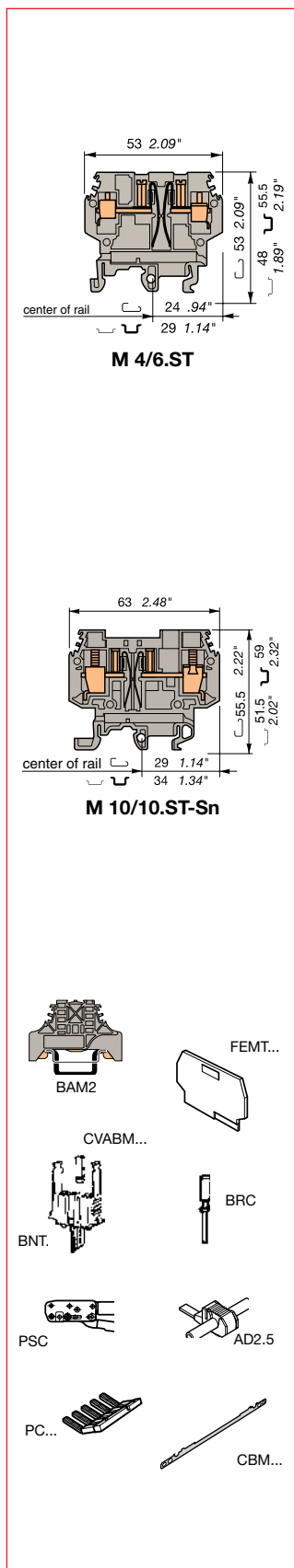



ESSAILEC terminal blocks

Screw clamp

The **PREMIUM** solution for testing the secondary circuits of current or voltage transformers.

ESSAILEC, approved by the major electricity utilities, remains the premium choice for the energy market.

Implemented in the transformers secondary circuits, ESSAILEC thanks to its intelligent “make before break” design eases and secures any intervention. Cutting the energy supply is avoided with zero risk for the operator.

The plug and socket connection cuts cost installation as well as in-situ wiring errors. ESSAILEC is ideal for the wiring of sub-assemblies in the secondary circuits.

ESSAILEC is designed to offer :

Great flexibility :

- Connection multi contacts « plug and play »
- Panel, rail, rack fixed mounting or stand-alone connector
- Two wiring technologies, up to 10 mm²

Extreme reliability :

- Non symmetric blocks
- Coding accessories
- IP20 design
- Locking system
- Sealed cover

1

Testing :

The ESSAILEC socket supplies energy to the protection or counting devices. The insertion of the test plug, which is connected to the measurement equipment, allows the testing of the devices, without perturbing the circuit.

ESSAILEC blocks are well adapted to current or voltage measurement :

- Current sockets with make before break contacts and pre-wired test plug for current measures
- Voltage sockets with open contacts and pre-wired test plug for voltage measures
- Up to 4 ammeters or 4 voltmeters connected to the test plug

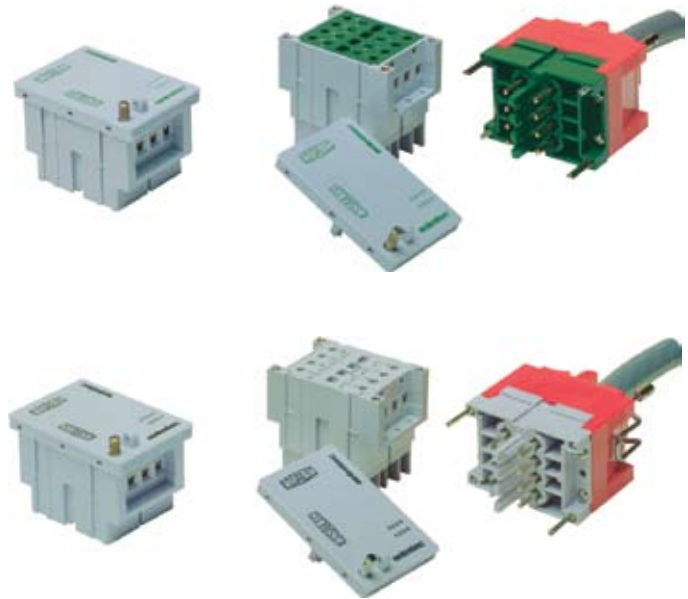

Distributing :

The ESSAILEC plug is continuously mounted on the socket to supply current or voltage to secondary circuits sub assemblies.

ESSAILEC blocks extreme versatility allow :

- Safe current distribution with current socket with mobile contacts since the secondary circuit is not cut when plug is removed
- Voltage or polarity distribution with dedicated voltage or polarity socket with closed contact

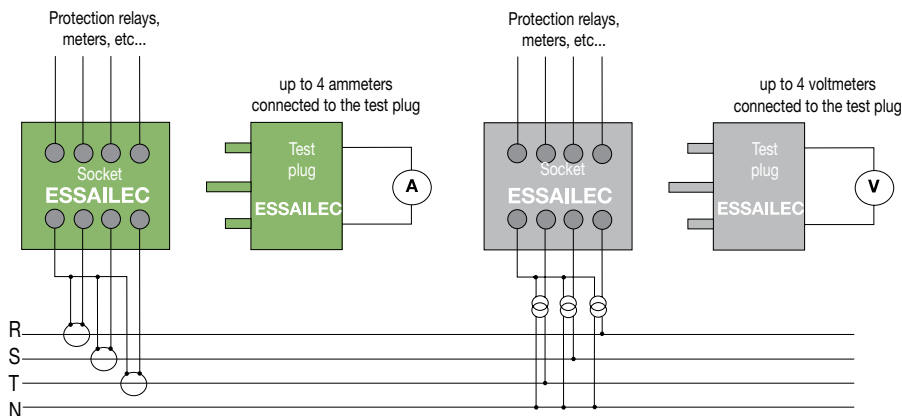

Safety connection terminal blocks

Screw clamp, DIN 1 - 3

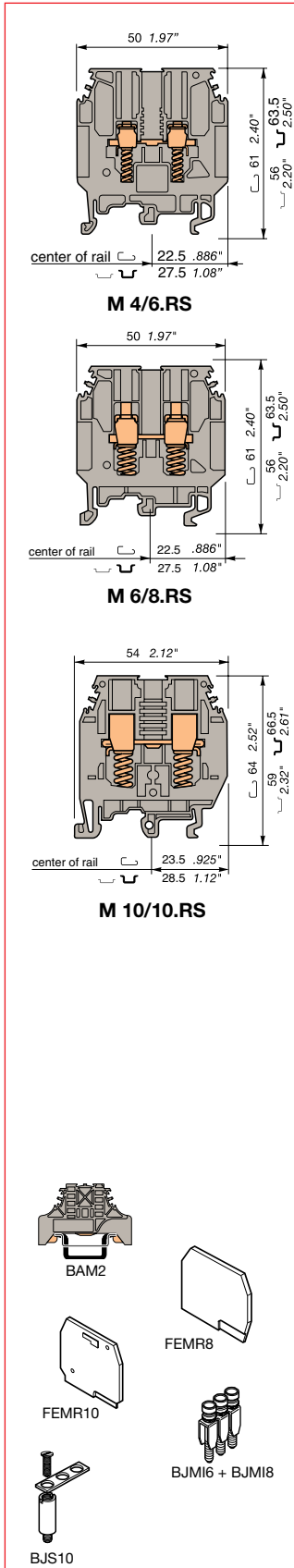

M 4/6.RS - 4 mm² blocks - 6 mm .238" spacing

Characteristics

		IEC NFC DIN	B.S TS 50-18	CSA
Wire size mm ² / AWG	Screw clamp	Solid wire 0.2 - 4		22-12 AWG
		Stranded wire 0.22 - 4		
Lugs		Solid wire 0.5 - 1.5	0.28 - 1.65	
		Stranded wire		
Voltage	V	1000	500	600
Current	A	32	25	25
Rated wire size	mm ² / AWG	4 mm ²	1.65 mm ²	12 AWG
Wire stripping length	mm / inches	13 mm / .51"		
Recommended torque (screw)	Nm / lb.in	0.5 - 0.8 Nm / 4.4 - 7.1 lb.in		

M 6/8.RS - 6 mm² blocks - 8 mm .315" spacing

Characteristics

		IEC NFC DIN	B.S TS 50-18	CSA
Wire size mm ² / AWG	Screw clamp	Solid wire 0.5 - 10		20-12 AWG
		Stranded wire 0.5 - 6		
Lugs		Solid wire	0.28 - 2.5	
		Stranded wire		
Voltage	V	800	500	600
Current	A	41	25	25
Rated wire size	mm ² / AWG	6	2.5	12 AWG
Wire stripping length	mm / inches	13 mm / .51"		
Recommended torque (screw)	Nm / lb.in	0.8 - 1 Nm / 7.1 - 8.9 lb.in		

M 10/10.RS - 10 mm² blocks - 10 mm .394" spacing

Characteristics

		IEC NFC DIN	B.S TS 50-18	UL/CSA
Wire size mm ² / AWG	Screw clamp	Solid wire 0.5 - 16		20 - 6 AWG
		Stranded wire 0.5 - 10		
Lugs		Solid wire	0.28 - 6	
		Stranded wire		
Voltage	V	900	500	600
Current	A	46	40	65
Rated wire size	mm ² / AWG	10 mm ²	6 mm ²	6 AWG
Wire stripping length	mm / inches	14 mm / .55"		
Recommended torque (screw)	Nm / lb.in	1.2 - 1.4 Nm / 10.6 - 12.3 lb.in		

Selection

Description	Type	Order P/N	Packaging
Block standard grey V2 spring under each screw-clamp	<input type="checkbox"/> M 4/6.RS	0115 930.13	50
Block standard blue V2 spring under each screw-clamp	<input type="checkbox"/> M 4/6.N.RS	0125 930.15	50
Block standard grey V2 spring under each screw-clamp	<input type="checkbox"/> M 6/8.RS	0115 685.12	50
Block standard beige V0 spring under each screw-clamp	<input type="checkbox"/> M 6/8.RS.V0	0195 685.13	50
Block standard grey V2 spring under each screw-clamp	<input type="checkbox"/> M 10/10.RS	0115 320.27	25

Accessories

End stop	BAM2 9.9 mm	0206 351.16	50
End section	grey <input type="checkbox"/> FEMR8 2.8 mm ①	0116 987.02	10
	grey <input type="checkbox"/> FEMR10 2.5 mm ③	0114 434.05	10
	beige <input type="checkbox"/> FEMR8 V0 2.8 mm ④	0196 987.03	10
Assembled jumper bar (with IP20 protection)	2 poles BJMI6 32 A ①	0176 663.00	10
	3 poles BJMI6 32 A ①	0176 664.01	10
	4 poles BJMI6 32 A ①	0176 665.02	10
	5 poles BJMI6 32 A ①	0176 666.03	10
	10 poles BJMI6 32 A ①	0176 667.04	10
Assembled jumper bar (with IP20 protection)	2 poles BJMI8 41 A ②	0176 669.16	10
	3 poles BJMI8 41 A ②	0176 670.13	10
	4 poles BJMI8 41 A ②	0176 671.00	10
	5 poles BJMI8 41 A ②	0176 672.01	10
	10 poles BJMI8 41 A ②	0176 673.02	10
Jumper bar not assembled	2 poles BJS10 57 A ③	0164 585.17	10
	3 poles BJS10 57 A ③	0164 586.10	10
	4 poles BJS10 57 A ③	0164 587.11	10
	5 poles BJS10 57 A ③	0168 273.11	10
	10 poles BJS10 57 A ③	0164 588.22	10

① Only for block M 4/6.RS
② Only for block M 6/8.RS

③ Only for block M 10/10.RS
④ For blocks M 4/6.RS and M 6/8.RS

Miniblocks

Feed through for DIN 2 rail

Screw clamp, \surd DIN 2

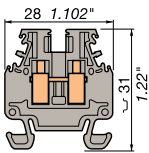

DR 1,5/4

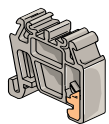

BADRL

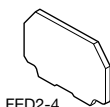

FED2-4

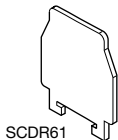

SCDR61



BJM4

DR 1,5/4 - 1.5 mm² blocks - 4 mm .157" spacing

Characteristics

		IEC	UL	CSA
		NFC DIN		
Wire size mm ² / AWG	Solid	0.2 - 1.5	24-16 AWG	24-16 AWG
	Stranded	0.22 - 1.5		
Voltage	V	500	300	200
Current	A	17.5	10	10
Rated wire size	mm ² / AWG	1.5 mm ²	16 AWG	16 AWG
Wire stripping length	mm / inches	7 mm / .275"		
Recommended screwdriver	Nm / lb.in	2.5 mm / .98"		

Selection

Description	Type	Order P/N	Packaging
Standard block grey	<input type="checkbox"/> DR 1,5/4	0110 106.25	50
Standard block grey V0	<input type="checkbox"/> DR 1,5/4.V0	0399 575.00	50

Accessories

End stop V0		BADRL 6.5 mm	0199 420.21	50	
End section	grey	<input type="checkbox"/> FED2-4 V0	0399 577.02	25	
	grey	<input type="checkbox"/> FED2-4 V2	0215 580.21	25	
Circuit separator	white	<input type="checkbox"/> SCDR61 0.3 mm	0173 016.10	25	
Assembled jumper bar (without IP20 protection)	2 poles	BJM4	17.5 A	0205 735.06	10
	3 poles	BJM4	17.5 A	0205 736.07	10
	5 poles	BJM4	17.5 A	0205 737.00	10
	10 poles	BJM4	17.5 A	0205 738.11	10

DR 1,5/5... - 1.5 mm² blocks - 5 mm .200" spacing

Characteristics

		IEC	UL	CSA
		NFC DIN		
Wire size mm ² / AWG	Solid	0.2 - 2.5	28 -12 AWG	28 - 14 AWG
	Stranded	0.22 - 1.5		
Voltage	V	250 Gr.C	300	300
Current	A	20	20	20
Rated wire size	mm ² / AWG	1.5 mm ²	12 AWG	14 AWG
Wire stripping length	mm / inches	8.5 mm / .335"		
Recommended screwdriver	Nm / lb.in	3.5 mm / .138"		
Recommended torque	Nm / lb.in	0.4 - 0.6 Nm / 3.5 - 5.3 lb.in		

Selection

Description	Type	Order P/N	Packaging	
Standard DIN 2 block	grey <input type="checkbox"/>	DR 1,5/5	0115 510.16	100
DIN 2 block with partition	grey <input type="checkbox"/>	DR 1,5/5.1	0112 086.02	50

Accessories

End stop V0		BADRL 6.5 mm	0199 420.21	50
End section	grey <input type="checkbox"/>	FEDR5 1 mm	0117 318.23	25
Assembled jumper bar (with IP20 protection)	2 poles	BJMI5 DR24 A	0176 704.02	10
	3 poles	BJMI5 DR24 A	0176 705.03	10
	4 poles	BJMI5 DR24 A	0176 706.04	10
	5 poles	BJMI5 DR24 A	0176 707.05	10
	10 poles	BJMI5 DR24 A	0176 708.16	10

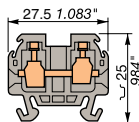

DR 1,5/5

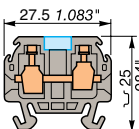

DR 1,5/5.1

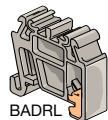

BADRL

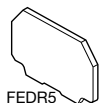

FEDR5



BJMI5 DR

Miniblocks

Feed through and ground for DIN 2 rail

Screw clamp, U DIN 2

DR 4/6.... - 4 mm² blocks - 6 mm .236" spacing

Characteristics

		IEC NFC DIN	UL	CSA
Wire size mm ² / AWG	Solid	0.2 - 4	22-12 AWG	18-12 AWG
	Stranded	0.22 - 4		
Voltage	V	500 Gr.C	250	300/150
Current	A	30	20	10/25
Rated wire size	mm ² / AWG	4 mm ²	12 AWG	12 AWG
Wire stripping length	mm / inches	9.5 mm / .37"		
Recommended screwdriver	Nm / lb.in	4 mm / .16"		

Selection

Description	Type	Order P/N	Packaging
DIN 2 standard block grey	<input type="checkbox"/> DR 4/6	0110 251.05	50
DIN 2 standard block blue	<input type="checkbox"/> DR 4/6.N	0120 251.07	50
DIN 2 block with partition grey	<input type="checkbox"/> DR 4/6.1	0110 491.17	50
DIN 2 block with partition blue	<input type="checkbox"/> DR 4/6.1.N	0120 491.11	50

Accessories

End stop V0		BADRL 6.5 mm	0199 420.21	50
End section	grey	<input type="checkbox"/> FEDR61 1 mm	0117 600.03	25
	blue	<input type="checkbox"/> FEDR61 1 mm	0127 600.05	10
Circuit separator	white	<input type="checkbox"/> SCDR610.3 mm	0173 016.10	25
Assembled jumper bar (without IP20 protection)	2 poles	BJM62 32 A	0173 217.26	10
	3 poles	BJM62 32 A	0173 218.07	10
	5 poles	BJM62 32 A	0173 219.00	10
	10 poles	BJM62 32 A	0173 221.22	10
		BJM62 32 A	0173 226.27	10

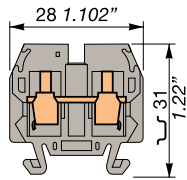

DR 4/6

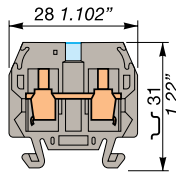

DR 4/6.1

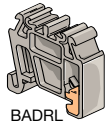

BADRL



FEDR61

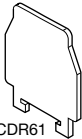

SCDR61



BJM62

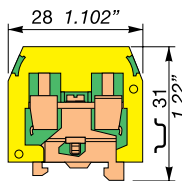

DR 4/6.P

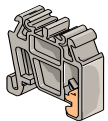

BADRL

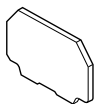

FEDR63



SCDR61

DR 4/6.P - 4 mm² ground block - 6 mm .236" spacing

Characteristics

		IEC NFC DIN	UL	CSA
Wire size mm ² / AWG	Solid	0.2 - 4	22 - 12 AWG	18 - 12 AWG
	Stranded	0.22 - 4		
Rated wire size	mm ² / AWG	4 mm ²	12 AWG	12 AWG
Wire stripping length	mm / inches	9.5 mm / .37"		
Recommended screwdriver	Nm / lb.in	4 mm / .16"		
Recommended torque	Nm / lb.in	0.5 - 0.8 Nm / 4.4 - 7.1 lb.in		

Selection

Description	Type	Order P/N	Packaging
Ground DIN 2 block green/yellow	<input type="checkbox"/> DR 4/6.P	0160 496.26	50

Accessories

End stop V0		BADRL 6.5 mm	0199 420.21	50
End section	yellow	<input type="checkbox"/> FEDR63 1 mm	0103 975.21	25
Circuit separator	white	<input type="checkbox"/> SCDR610.3 mm	0173 016.10	25

Angled terminal blocks

Feed through and ground

Spring clamp, \angle DIN 3

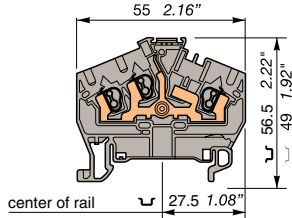

D 2,5/5.1.3L

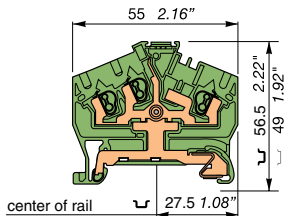
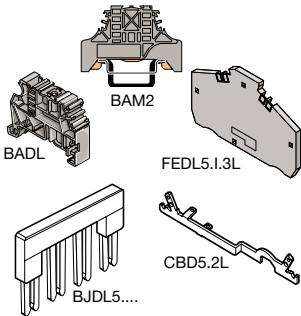

D 2,5/5.1.P.3L

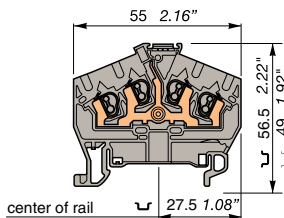

D 2,5/5.1.4L

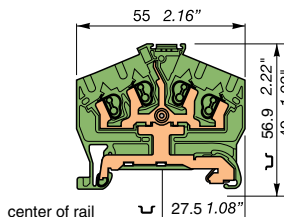
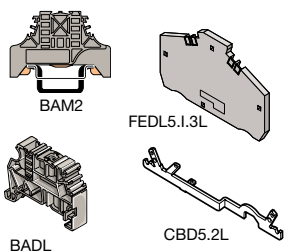

D 2,5/5.1.P.4L

D 2,5/5.1.3L - 2.5 mm² blocks - 5 mm .198" spacing

Characteristics		IEC		UL	CSA
		NFC	DIN		
Wire size mm ² / AWG	Solid	0.12 - 4		26-12 AWG	26-12 AWG
	Stranded	0.12 - 2.5			
	isolated ferrules	0.5 - 2.5			
Voltage	V	800	600	600	600
Current	A	24	15	15	15
Short circuit current (D 2,5/5.1.P1.3L)	A / s	300 A/1s			
Short circuit current (D 2,5/5.1.P.3L)	A / s	300 A/1s			
Rated wire size	mm ² / AWG	2.5 mm ²		12 AWG	12 AWG
Wire stripping length	mm / inches	9.5 mm / .37"			

Selection

Description	Type	Order P/N	Packaging
Standard block grey	<input type="checkbox"/> D 2,5/5.1.3L	0399 068.17	50
Standard block blue	<input type="checkbox"/> D 2,5/5.1.N.3L	0399 067.06	50
Standard yellow	<input type="checkbox"/> D 2,5/5.1.3L	0400 219.11	50
Standard block orange	<input type="checkbox"/> D 2,5/5.1.3L	0399 260.20	50
Ground block yellow/green	<input type="checkbox"/> D 2,5/5.1.P1.3L ①	0399 066.05	50
Ground block green/yellow	<input type="checkbox"/> D 2,5/5.1.P.3L ②	0399 072.03	50

Accessories

End stop	light grey	BADL	9 mm	0399 903.02	(screwless)	50
		BAM2	9.9 mm	0399 967.01	(with screw)	50
End section	grey	<input type="checkbox"/> FEDL5.1.3L	2.5 mm	0290 311.06		50
	orange	<input type="checkbox"/> FEDL5.1.3L	2.5 mm	0290 314.01		50
Assembled jumper bar 2 poles (with IP20 protection)		BJDL5.2	24 A ③	0291 102.23		50
		BJDL5.3	24 A ③	0291 103.24		50
		BJDL5.4	24 A ③	0291 104.25		50
		BJDL5.5	24 A ③	0291 105.26		20
		BJDL5.10	24 A ③	0291 110.26		20
Shielding connector		CBD5.2L	0.5 MM ③	0291 077.24		50

D 2,5/5.1.4L - 2.5 mm² blocks - 5 mm .198" spacing

Characteristics		IEC		UL	CSA
		NFC	DIN		
Wire size mm ² / AWG	Solid	0.12 - 4		26-12 AWG	26-12 AWG
	Stranded	0.12 - 2.5			
	isolated ferrules	0.5 - 2.5			
Voltage	V	800	600	600	600
Current	A	24	15	15	15
Short circuit current (D 2,5/5.1.P1.4L)	A / s	300 A/1s			
Short circuit current (D 2,5/5.1.P.4L)	A / s	300 A/1s			
Rated wire size	mm ² / AWG	2.5 mm ²		12 AWG	12 AWG
Wire stripping length	mm / inches	9.5 mm / .37"			

Selection

Description	Type	Order P/N	Packaging
Standard block grey	<input type="checkbox"/> D 2,5/5.1.4L	0399 071.02	50
Standard block blue	<input type="checkbox"/> D 2,5/5.1.N.4L	0399 070.15	50
Standard yellow	<input type="checkbox"/> D 2,5/5.1.4L	0400 220.16	50
Standard block orange	<input type="checkbox"/> D 2,5/5.1.4L	0399 270.22	50
Ground block yellow/green	<input type="checkbox"/> D 2,5/5.1.P1.4L ①	0399 069.10	50
Ground block green/yellow	<input type="checkbox"/> D 2,5/5.1.P.4L ②	0399 073.04	50

Accessories

End stop	light grey	BADL	9 mm	0399 903.02	(screwless)	50
		BAM2	9.9 mm	0399 967.01	(with screw)	50
End section	grey	<input type="checkbox"/> FEDL5.1.3L	2.5 mm	0290 311.06		50
	orange	<input type="checkbox"/> FEDL5.1.3L	2.5 mm	0290 314.01		50
Shielding connector		CBD5.2L	0.5 mm	0291 077.24		50

① Without rail contact.
 ② With rail contact.
 ③ Except for D 2,5/5.1.P1.3L and D 2,5/5.1.P.3L
 ④ Except for D 2,5/5.1.P1.4L and D 2,5/5.1.P.4L

Feed through and ground terminal blocks

Spring clamp, DIN 3

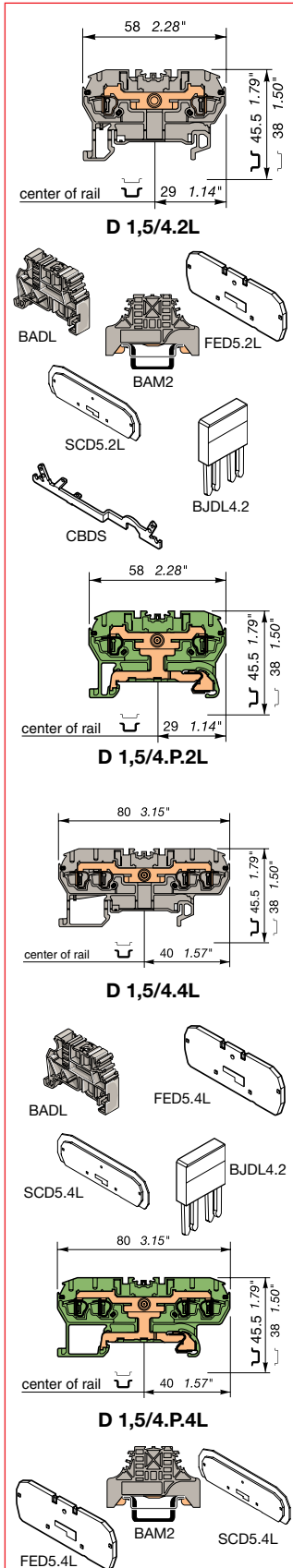

D 1,5/4.2L - 1.5 mm² blocks - 4 mm .158" spacing

Characteristics

Wire size mm ² / AWG	Solid	IEC	UL	CSA
		NFC	DIN	
	Stranded	0.12 - 2.5	26-16 AWG	26-16 AWG
	isolated ferrules	0.5 - 1		
Voltage	V	800	600	600
Current	A	18		
Short circuit current (D 1,5/4.PI.2L)	A / s	180 A/1s		
Short circuit current (D 1,5/4.P.2L)	A / s	180A/1s		
Rated wire size	mm ² / AWG	1.5 mm ²	16 AWG	16 AWG
Wire stripping length	mm / inches	9.5 mm / .37"		

Selection

Description	Type	Order P/N	Packaging
Standard block grey	<input type="checkbox"/> D 1,5/4.2L	0290 371.12	50
Standard block blue	<input type="checkbox"/> D 1,5/4.N.2L	0290 373.14	50
Standard block orange	<input type="checkbox"/> D 1,5/4.2L	0290 372.13	50
Ground block yellow/green	<input type="checkbox"/> D 1,5/4.PI.2L ①	0290 380.10	50
Ground block green/yellow	<input type="checkbox"/> D 1,5/4.P.2L ②	0290 379.22	50

Accessories

Description	Type	Order P/N	Packaging
End stop	BADL 9 mm	0399 903.02	(screwless) 50
	light grey BAM2 9.9 mm	0399 967.01	(with screw) 50
End section	grey <input type="checkbox"/> FED5.2L 2.5 mm	0291 061.24	20
	orange <input type="checkbox"/> FED5.2L 2.5 mm	0291 062.25	20
Separator	orange <input type="checkbox"/> SCD5.2L 2.5 mm	0291 352.04	20
	grey <input type="checkbox"/> SCD5.2L 2.5 mm	0291 351.03	20
Jumper bar, IP20	2 poles <input type="checkbox"/> BJD4.2 18 A ③	0291 642.06	50
Shielding connector	CBDS 0.5 mm ④	0291 702.04	50

D 1,5/4.4L - 1.5 mm² blocks - 4 mm .158" spacing

Characteristics

Wire size mm ² / AWG	Solid	IEC	UL	CSA
		NFC	DIN	
	Stranded	0.12 - 2.5	26-16 AWG	26-16 AWG
	isolated ferrules	0.5 - 1		
Voltage	V	800	600	600
Current	A	18		
Short circuit current (D 2,5/5.I.PI.4L)	A / s	180 A/1s		
Short circuit current (D 2,5/5.I.P.4L)	A / s	180 A/1s		
Rated wire size	mm ² / AWG	1.5 mm ²	16 AWG	16 AWG
Wire stripping length	mm / inches	9.5 mm / .37"		

Selection

Description	Type	Order P/N	Packaging
Standard block grey	<input type="checkbox"/> D 1,5/4.4L	0290 381.05	50
Standard block blue	<input type="checkbox"/> D 1,5/4.N.4L	0290 383.07	50
Standard block orange	<input type="checkbox"/> D 1,5/4.4L	0290 382.06	50
Ground block yellow/green	<input type="checkbox"/> D 1,5/4.PI.4L ①	0290 390.12	50
Ground block green/yellow	<input type="checkbox"/> D 1,5/4.P.4L ②	0290 389.15	50

Accessories

Description	Type	Order P/N	Packaging
End stop	BADL 9 mm	0399 903.02	(screwless) 50
	light grey BAM2 9.9 mm	0399 967.01	(with screw) 50
End section	grey <input type="checkbox"/> FED5.4L 2.5 mm	0291 041.20	20
	orange <input type="checkbox"/> FED5.4L 2.5 mm	0291 042.21	20
Separator	orange <input type="checkbox"/> SCD5.4L 2.5 mm	0291 372.00	20
	grey <input type="checkbox"/> SCD5.4L 2.5 mm	0291 371.07	20
Jumper bar, IP20	2 poles <input type="checkbox"/> BJD4.2 18 A ④	0291 642.06	50

- ① Without rail contact.
- ② With rail contact.
- ③ Except for D 1,5/4.I.PI.2L and D 1,5/4.I.P.2L
- ④ Except for D 2,5/5.I.PI.4L and D 2,5/5.I.P.4L

Feed through and ground terminal blocks

Spring clamp, U DIN 3

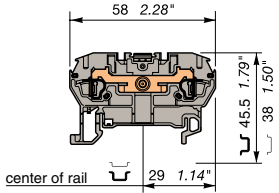

D 2,5/5.2L

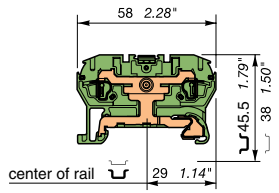

D 2,5/5.P.2L

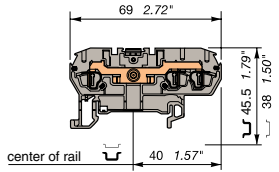

D 2,5/5.3L

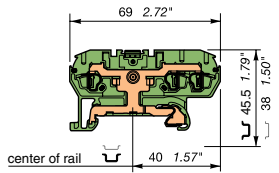

D 2,5/5.P.3L

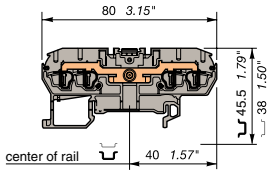

D 2,5/5.4L

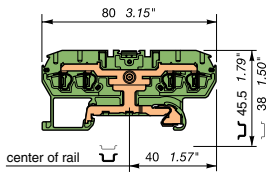

D 2,5/5.P.4L

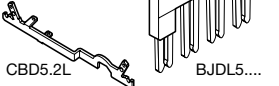
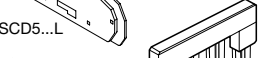
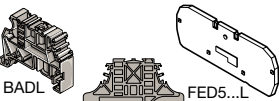

D 2,5/5...L - 2.5 mm² blocks - 5 mm .198" spacing

Characteristics

		IEC NFC DIN	UL	CSA
Wire size mm ² / AWG	Solid	0.12- 4	26-12 AWG	26-12 AWG
	Stranded	0.12 - 2.5		
	isolated ferrules	0.5 - 2.5		
Voltage	V	800	600	600
Current	A	24	15	15
Short circuit current (D 2,5/5.PI...L)	A / s	300 A/1s		
Short circuit current (D 2,5/5.P...L)	A / s	300 A/1s		
Rated wire size	mm ² / AWG	2.5 mm ²	12 AWG	12 AWG
Wire stripping length	mm / inches	9.5 mm / .37"		

D 2,5/5.2L Selection

Description	Type	Order P/N	Packaging
Standard block grey	□ D 2,5/5.2L	0290 021.27	50
Standard block blue	□ D 2,5/5.N.2L	0290 023.21	50
Standard block yellow	□ D 2,5/5.2L	0290 027.25	50
Standard block orange	□ D 2,5/5.2L	0290 022.20	50
Standard block red	■ D 2,5/5.2L	0290 024.22	50
Standard block black	■ D 2,5/5.2L	0290 026.24	50
Standard block green	■ D 2,5/5.2L	0290 028.06	50
Standard block white	□ D 2,5/5.2L	0290 025.23	50
Standard block brown	■ D 2,5/5.2L	0290 464.00	50
Standard block violet	■ D 2,5/5.2L	0290 465.01	50
Ground block yellow/green	■ D 2,5/5.PI.2L ①	0290 030.04	50
Ground block green/yellow	■ D 2,5/5.P.2L ②	0290 029.07	50

D 2,5/5.3L Selection

Standard block grey	□ D 2,5/5.3L	0290 031.21	50
Standard block blue	□ D 2,5/5.N.3L	0290 033.23	50
Standard block orange	□ D 2,5/5.3L	0290 032.22	50
Standard block red	■ D 2,5/5.3L	0290 034.24	50
Standard block black	■ D 2,5/5.3L	0290 036.26	50
Standard block white	□ D 2,5/5.3L	0290 035.25	50
Standard block yellow	□ D 2,5/5.3L	0290 037.27	50
Ground block yellow/green	■ D 2,5/5.PI.3L ①	0290 040.16	50
Ground block green/yellow	■ D 2,5/5.P.3L ②	0290 039.01	50

D 2,5/5.4L Selection

Standard block grey	□ D 2,5/5.4L	0290 011.25	50
Standard block blue	□ D 2,5/5.N.4L	0290 013.27	50
Standard block orange	□ D 2,5/5.4L	0290 012.26	50
Ground block yellow/green	■ D 2,5/5.PI.4L ①	0290 020.02	50
Ground block green/yellow	■ D 2,5/5.P.4L ②	0290 019.05	50

Accessories

End stop		BADL	9 mm	0399 903.02	(screwless)	50
	light grey	BAM2	9.9 mm	0399 967.01	(with screw)	50
End section	grey	□ FED5.2L	2.5 mm ③	0291 061.24		20
	orange	■ FED5.2L	2.5 mm ③	0291 062.25		20
	grey	□ FED5.3L	2.5 mm ④	0291 051.22		20
	orange	■ FED5.3L	2.5 mm ④	0291 052.23		20
	grey	□ FED5.4L	2.5 mm ⑤	0291 041.20		20
	orange	■ FED5.4L	2.5 mm ⑤	0291 042.21		20
Separator	orange	■ SCD5.2L	2.5 mm ③	0291 352.04		20
	grey	□ SCD5.2L	2.5 mm ③	0291 351.03		20
	orange	■ SCD5.3L	2.5 mm ④	0291 362.06		20
	orange	■ SCD5.4L	2.5 mm ⑤	0291 372.00		20
Jumper bar, IP20	2 poles	BJDL5.2	24 A	0291 102.23		50
	3 poles	BJDL5.3	24 A	0291 103.24		50
	4 poles	BJDL5.4	24 A	0291 104.25		50
	5 poles	BJDL5.5	24 A	0291 105.26		20
	10 poles	BJDL5.10	24 A	0291 110.26		20
Shielding connector		CBD5.2L	0.5 mm ③	0291 077.24		50

① Without rail contact.
 ② With rail contact.
 ③ Only for D 2,5/5...2L
 ④ Only for D 2,5/5...3L
 ⑤ Only for D 2,5/5...4L

Feed through and ground terminal blocks

Spring clamp, DIN 3



D 4/6...L - 4 mm² blocks - 6 mm .238" spacing

Characteristics

Wire size mm ² / AWG	Solid Stranded isolated ferrules	IEC	UL	CSA
		NFC DIN		
		0.2 - 6	24-10 AWG	24-10 AWG
		0.2 - 4		
		0.5 - 4		
Voltage	V	800	600	600
Current	A	32	25	25
Short circuit current (D 4/6.PI...L)	A / s	480 A/1s		
Short circuit current (D 4/6.P...L)	A / s	480 A/1s		
Rated wire size	mm ² / AWG	4 mm ²	10 AWG	10 AWG
Wire stripping length	mm / inches	11 mm / .43"		

D 4/6.2L Selection

Description	Type	Order P/N	Packaging
Standard block grey	D 4/6.2L	0290 061.07	50
Standard block blue	D 4/6.N.2L	0290 063.01	50
Standard block orange	D 4/6.2L	0290 062.00	50
Standard block black	D 4/6.2L	0290 066.04	50
Standard block red	D 4/6.2L	0290 064.02	50
Standard block yellow	D 4/6.2L	0290 067.05	50
Ground block yellow/green	D 4/6.PI.2L ①	0290 070.14	50
Ground block green/yellow	D 4/6.P.2L ②	0290 069.17	50

D 4/6.3L Selection

Standard block grey	D 4/6.3L	0290 405.06	50
Standard block blue	D 4/6.N.3L	0290 407.00	50
Standard block orange	D 4/6.3L	0290 406.07	50
Ground block yellow/green	D 4/6.PI.3L ①	0290 408.11	50
Ground block green/yellow	D 4/6.P.3L ②	0290 409.12	50

D 4/6.4L Selection

Standard block grey	D 4/6.4L	0290 410.06	50
Standard block blue	D 4/6.N.4L	0290 412.24	50
Standard block orange	D 4/6.4L	0290 411.23	50
Ground block yellow/green	D 4/6.PI.4L ①	0290 413.25	50
Ground block green/yellow	D 4/6.P.4L ②	0290 414.26	50

Accessories

End stop	light grey	BADL	9 mm	0399 903.02	(screwless)	50
		BAM2	9.9 mm	0399 967.01	(with screw)	50
End section	grey	FED5.2L	2.5 mm ③	0291 061.24		20
	orange	FED5.2L	2.5 mm ③	0291 062.25		20
	grey	FED6.3L	2.5 mm ④	0291 694.24		20
	orange	FED6.3L	2.5 mm ④	0291 695.25		20
	grey	FED6.4L	2.5 mm ⑤	0291 696.26		20
	orange	FED6.4L	2.5 mm ⑤	0291 697.27		20
Separator	orange	SCD5.2L	2.5 mm ③	0291 352.04		20
	grey	SCD5.2L	2.5 mm ③	0291 351.03		20
Jumper bar, IP20	2 poles	BJDL6.2	32 A	0291 128.24		50
	3 poles	BJDL6.3	32 A	0291 129.25		50
	4 poles	BJDL6.4	32 A	0291 194.17		50
	5 poles	BJDL6.5	32 A	0291 195.10		20

- ① Without rail contact.
- ② With rail contact.
- ③ Only for D 4/6...2L
- ④ Only for D 4/6...3L
- ⑤ Only for D 4/6...4L

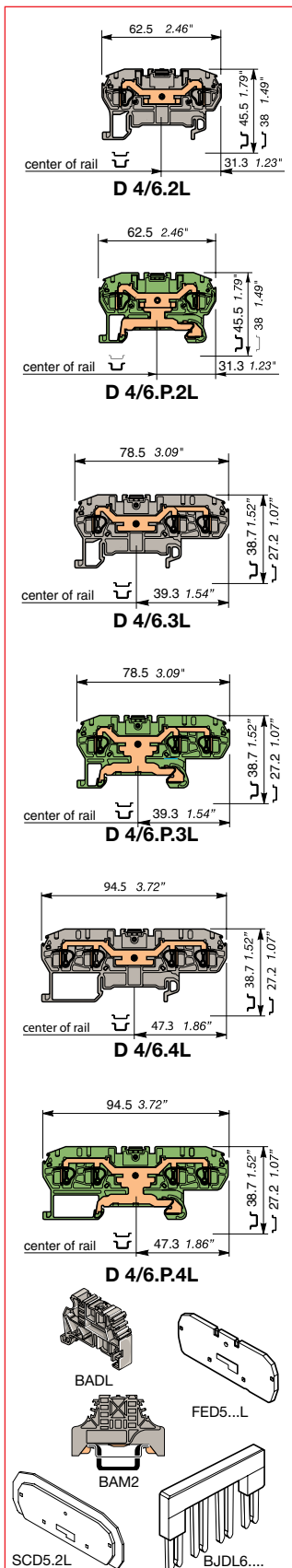

Feed through and ground terminal blocks

Spring clamp, U DIN 3

D 6/8.2L - 6 mm² blocks - 8 mm .315" spacing

Characteristics

Wire size mm ² / AWG	Solid Stranded isolated ferrules	IEC	UL	CSA
		NFC DIN		
		0.5 - 10	22-8 AWG	22-8 AWG
		0.5 - 6		
		0.5 - 6		
Voltage	V	800	600	600
Current	A	41	40	40
Short circuit current (D6/8.PI.2L)	A / s	720 A/1s		
Short circuit current (D6/8.P.2L)	A / s	720 A/1s		
Rated wire size	mm ² / AWG	6 mm ²	8 AWG	8 AWG
Wire stripping length	mm / inches	12.5 mm / .49"		

Selection

Description	Type	Order P/N	Packaging
Standard block grey	<input type="checkbox"/> D 6/8.2L	0290 081.24	50
Standard block blue	<input type="checkbox"/> D 6/8.N.2L	0290 083.26	50
Standard block orange	<input type="checkbox"/> D 6/8.2L	0290 082.25	50
Standard block black	<input type="checkbox"/> D 6/8.2L	0290 086.21	50
Standard block red	<input type="checkbox"/> D 6/8.2L	0290 084.27	50
Standard block yellow	<input type="checkbox"/> D 6/8.2L	0290 087.22	50
Ground block yellow/green	<input type="checkbox"/> D 6/8.PI.2L ①	0290 090.01	50
Ground block green/yellow	<input type="checkbox"/> D 6/8.P.2L ②	0290 089.04	50

Accessories

End stop	Type	Order P/N	Packaging
light grey	BADL 9 mm	0399 903.02	(screwless) 50
	BAM2 9.9 mm	0399 967.01	(with screw) 50
End section	grey <input type="checkbox"/> FED8.2L 2.5 mm	0291 161.25	20
	orange <input type="checkbox"/> FED8.2L 2.5 mm	0291 162.26	20
Assembled jumper bar (with IP20 protection)	2 poles	BJDL8.2 41 A ③	0291 122.16 50
	3 poles	BJDL8.3 41 A ③	0291 123.17 50
	4 poles	BJDL8.4 41 A ③	0291 144.24 50
	5 poles	BJDL8.5 41 A ③	0291 145.25 20

D 10/10.2L - 10 mm² blocks - 10 mm .394" spacing

Characteristics

Wire size mm ² / AWG	Solid Stranded isolated ferrules	IEC	UL	CSA
		NFC DIN		
		0.5 - 16	20-6 AWG	20-6 AWG
		0.5 - 10		
Voltage	V	1000	600	600
Current	A	57	50	50
Short circuit current (D 10/10.PI.2L)	A / s	1200 A/1s		
Short circuit current (D 10/10.P.2L)	A / s	1200 A/1s		
Rated wire size	mm ² / AWG	10 mm ²	6 AWG	6 AWG
Wire stripping length	mm / inches	12 mm / .47"		

Selection

Description	Type	Order P/N	Packaging
Standard block grey	<input type="checkbox"/> D 10/10.2L	0290 291.03	50
Standard block blue	<input type="checkbox"/> D 10/10.N.2L	0290 293.05	50
Standard block orange	<input type="checkbox"/> D 10/10.2L	0290 292.04	50
Standard block black	<input type="checkbox"/> D 10/10.2L	0290 296.00	50
Standard block red	<input type="checkbox"/> D 10/10.2L	0290 294.06	50
Standard block yellow	<input type="checkbox"/> D 10/10.2L	0290 297.01	50
Ground block yellow/green	<input type="checkbox"/> D 10/10.PI.2L ①	0290 300.20	50
Ground block green/yellow	<input type="checkbox"/> D 10/10.P.2L ②	0290 299.13	50

Accessories

End stop	Type	Order P/N	Packaging
light grey	BADL 9 mm	0399 903.02	(screwless) 50
	BAM2 9.9 mm	0399 967.01	(with screw) 50
End section	grey <input type="checkbox"/> FED10.2L 2.5 mm	0291 461.22	20
	orange <input type="checkbox"/> FED10.2L 2.5 mm	0291 462.23	20
Assembled jumper bar (with IP20 protection)	2 poles	BJDL1.10.2 57 A ④	0291 472.25 50
	3 poles	BJDL1.10.3 57 A ④	0291 474.27 50
	4 poles	BJDL1.10.4 57 A ④	0291 476.21 50
	5 poles	BJDL1.10.5 57 A ④	0291 478.03 50

- ① Without rail contact.
- ② With rail contact.
- ③ Except for D 6/8.PI.2L and D 6/8.P.2L
- ④ Except for D 10/10.PI.2L and D 10/10.P.2L

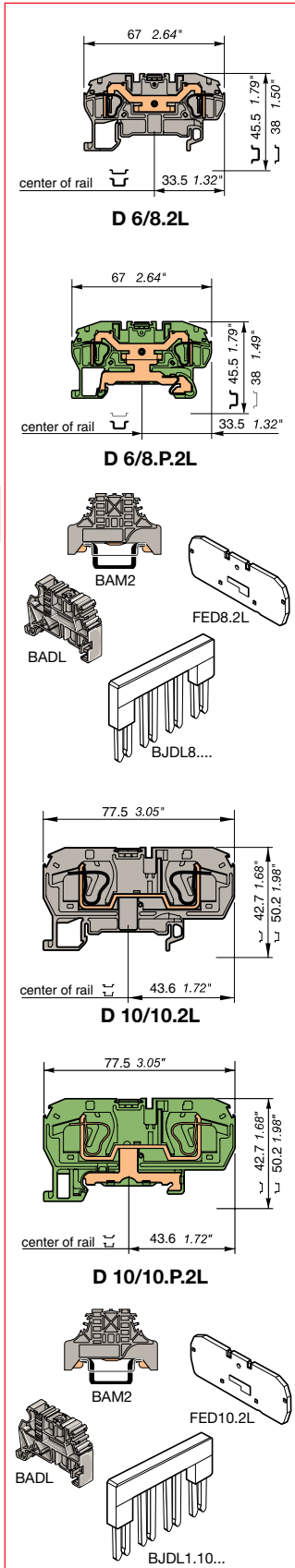

Feed through and ground terminal blocks

Spring clamp, \sqcup DIN 3



D 16/12.2L - 16 mm² blocks - 12 mm .473" spacing

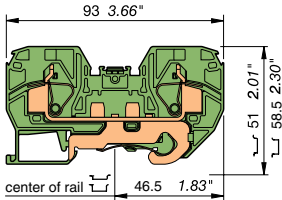

D 16/12.2L

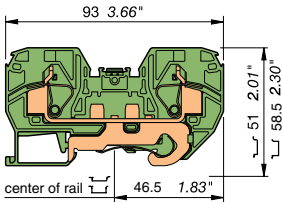

D 16/12.P.2L

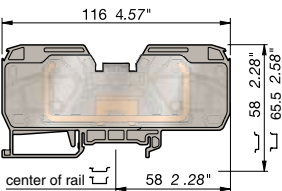
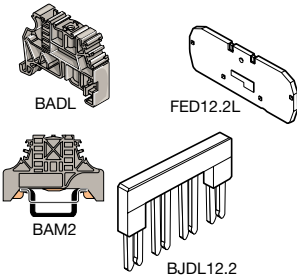

D 35/16.2L

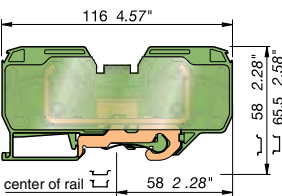

D 35/16.P.2L

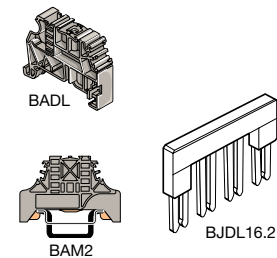

Characteristics

Wire size mm ² / AWG	Solid Stranded isolated ferrules	IEC	UL	CSA
		NFC DIN		
		0.5 - 25	20-6 AWG	20-6 AWG
Voltage		800	600	600
Current		76	54	54
Short circuit current (D16/12.PI.2L)	A / s	1920 A/1s		
Short circuit current (D16/12.P.2L)	A / s	1920 A/1s		
Rated wire size	mm ² / AWG	16 mm ²	6 AWG	6 AWG
Wire stripping length	mm / inches	19 mm / .79"		

Selection

Description	Type	Order P/N	Packaging
Standard block grey	<input type="checkbox"/> D 16/12.2L	0399 581.27	25
Standard block blue	<input type="checkbox"/> D 16/12.N.2L	0399 582.20	25
Standard block black	<input type="checkbox"/> D 16/12.2L	0400 178.10	25
Standard block red	<input type="checkbox"/> D 16/12.2L	0400 179.11	25
Standard block yellow	<input type="checkbox"/> D 16/12.2L	0400 180.07	25
Ground block yellow/green	<input type="checkbox"/> D 16/12.PI.2L ①	0399 583.21	25
Ground block green/yellow	<input type="checkbox"/> D 16/12.P.2L ②	0399 584.22	25

Accessories

End stop		BADL	9 mm	0399 903.02	(screwless)	50
	light grey	BAM2	9.9mm	0399 967.01	(with screw)	50
End section	grey	<input type="checkbox"/> FED12.2L	2.5 mm	0399 571.04		10
	blue	<input type="checkbox"/> FED12.2L	2.5 mm	0399 572.05		10
	green	<input type="checkbox"/> FED12.2L	2.5 mm	0399 574.07		10
Assembled jumper bar	2 poles	<input type="checkbox"/> BJD12.2	76 A ③	0399 563.04		25

D 35/16.2L - 35 mm² blocks - 16 mm .630" spacing

Characteristics

Wire size mm ² / AWG	Solid Stranded isolated ferrules	IEC	UL	CSA
		NFC DIN		
		2.5 - 50	14-2 AWG	14-2 AWG
Voltage		800	600	600
Current		125	93	93
Short circuit current (D 35/16.PI.2L)	A / s	4200 A/1s		
Short circuit current (D 35/16.P.2L)	A / s	4200 A/1s		
Rated wire size	mm ² / AWG	35 mm ²	2 AWG	2 AWG
Wire stripping length	mm / inches	26 mm / 1.02"		

Selection

Description	Type	Order P/N	Packaging
Standard block grey	<input type="checkbox"/> D 35/16.2L	0399 617.02	10
Standard block blue	<input type="checkbox"/> D 35/16.N.2L	0399 618.13	10
Standard block black	<input type="checkbox"/> D 35/16.2L	0400 181.24	10
Standard block red	<input type="checkbox"/> D 35/16.2L	0400 182.22	10
Standard block yellow	<input type="checkbox"/> D 35/16.2L	0400 183.26	10
Ground block yellow/green	<input type="checkbox"/> D 35/16.PI.2L ①	0399 619.14	10
Ground block green/yellow	<input type="checkbox"/> D 35/16.P.2L ②	0399 620.11	10

Accessories

End stop		BADL	9 mm	0399 903.02	(screwless)	50
	light grey	BAM2	9.9 mm	0399 967.01	(with screw)	50
Assembled jumper bar	2 poles	<input type="checkbox"/> BJD16.2	115 A ④	0399 621.06		25

① Without rail contact.
 ② With rail contact.
 ③ Except for D 16/12.PI.2L and D 16/12.P.2L
 ④ Except for D 35/16.PI.2L and D 35/16.P.2L

Feed through terminal blocks

Double deck & terminal blocks for sensors/actuators

Spring clamp, U DIN 3

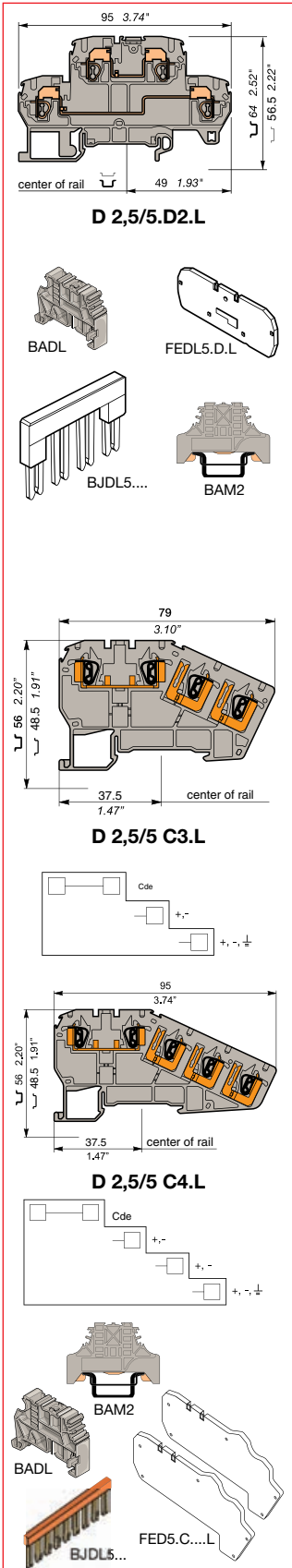

D 2,5/5.D2.L - 2.5 mm² blocks - 5 mm .198" spacing

Characteristics		IEC		UL	CSA
		NFC	DIN		
Wire size mm ² / AWG	Solid	0.12 - 4		26-12 AWG	26-12 AWG
	Stranded	0.12 - 2.5			
	isolated ferrules	0.5 - 2.5			
Voltage	V	500	300	300	
Current	A	20	20	20	
Rated wire size	mm ² / AWG	2.5 mm ²	12 AWG	12 AWG	
Wire stripping length	mm / inches	9.5 mm / .37"			

Selection

Description	Type	Order P/N	Packaging
Standard block grey	<input type="checkbox"/> D 2,5/5.D2.L	0290 161.00	50
Standard block blue	<input type="checkbox"/> D 2,5/5.D2.N.L	0290 163.02	50

Accessories

End stop	light grey	BADL	9 mm	0399 903.02	(screwless)	50
		BAM2	9.9 mm	0399 967.01	(with screw)	50
End section	grey	<input type="checkbox"/> FEDL5.D.L	2.5 mm	0291 441.26		20
Assembled jumper bar (with IP20 protection)	2 poles	<input checked="" type="checkbox"/> BJDLS.2	24 A	0291 102.23		50
	3 poles	<input checked="" type="checkbox"/> BJDLS.3	24 A	0291 103.24		50
	4 poles	<input checked="" type="checkbox"/> BJDLS.4	24 A	0291 104.25		50
	5 poles	<input checked="" type="checkbox"/> BJDLS.5	24 A	0291 105.26		20
	10 poles	<input checked="" type="checkbox"/> BJDLS.10	24 A	0291 110.26		20

D 2,5/5 C...L - 2.5 mm² blocks - 5 mm .198" spacing

Characteristics		IEC		UL	CSA
		NFC	DIN		
Wire size mm ² / AWG	Solid	0.14 - 2.5		26-16 AWG	26-16 AWG
	Stranded	0.14 - 2.5			
	isolated ferrules	0.5 - 2.5			
Voltage	V	300	300	300	
Current	A	17.5	10	10	
Rated wire size	mm ² / AWG	1.5 mm ²	16 AWG	16 AWG	
Wire stripping length	mm / inches	9.5 mm / .37"			

Selection

Description	Type	Order P/N	Packaging
Standard block grey	<input type="checkbox"/> D 2,5/5 C3L	0290 350.21	50
Standard block grey	<input type="checkbox"/> D 2,5/5 C4L	0290 354.11	50

Accessories

End stop	light grey	BADL	9 mm	0399 903.02	(screwless)	50
		BAM2	9.9 mm	0399 967.01	(with screw)	50
End sections	grey	<input type="checkbox"/> FED5.C3.L	5 mm	0290 358.25		20
	grey	<input type="checkbox"/> FED5.C3.L	5 mm	0290 360.23		20
Assembled jumper bar (with IP20 protection)	2 poles	<input checked="" type="checkbox"/> BJDLS.2	24 A	0291 102.23		50
	3 poles	<input checked="" type="checkbox"/> BJDLS.3	24 A	0291 103.24		50
	4 poles	<input checked="" type="checkbox"/> BJDLS.4	24 A	0291 104.25		50
	5 poles	<input checked="" type="checkbox"/> BJDLS.5	24 A	0291 105.26		20
	10 poles	<input checked="" type="checkbox"/> BJDLS.10	24 A	0291 110.26		20

- ① Without rail contact.
- ② With rail contact.
- ③ Except for D 16/12.PI.2L and D 16/12.P.2L
- ④ Except for D 35/16.PI.2L and D 35/16.P.2L

Terminal blocks for distribution boxes

Spring clamp, \sqcup DIN 3



D 2,5/5... .L - 2,5 mm² closed blocks - 5 mm .198" spacing

Characteristics

		IEC NFC DIN	UL	CSA
Wire size mm ² / AWG	Solid	0.14 - 4 mm ²	26-12 AWG	26-12 AWG
	Stranded	0.14 - 2.5 mm ²		
Isolating cover		0.5 - 2.5 mm ²		
Ground bar ①		10 x 3 mm		
Voltage	V	400 V / 250 V ②	300 V	300 V
		400V ③		
Pulse	kV	6 kV / 4 kV ④		
		6 kV ④		
Rated Current	A	20A ④, 24A	20 A	20 A
Short circuit current ②	A / s	300 A/1s		
Rated wire size	mm ² / AWG	2.5 mm ² / A2	12 AWG	12 AWG
Wire stripping length	mm / inches		9.5 mm / .37"	

Selection

Description	Type	Order P/N	Packaging
-------------	------	-----------	-----------

D 2,5/5.NTLPL

- 1 circuit "disconnect neutral" with busbar connection, blue marking
- 1 circuit "feed-through"
- 1 circuit "ground" connected to the rail, yellow/green marking

Spring block	grey V0 <input type="checkbox"/>	D 2,5/5.NTLPL	0290 322.01	40
--------------	----------------------------------	---------------	-------------	----

D 2,5/5.NLPL

- 1 circuit "neutral", blue marking
- 1 circuit "feed-through"
- 1 circuit "ground" connected to the rail, yellow/green marking

Spring block	grey V0 <input type="checkbox"/>	D 2,5/5.NLPL	0290 324.03	40
--------------	----------------------------------	--------------	-------------	----

D 2,5/5.LLPL

- 2 circuits "feed-through"
- 1 circuit "ground" connected to the rail, yellow/green marking

Spring block	grey V0 <input type="checkbox"/>	D 2,5/5.LLPL	0290 326.05	40
--------------	----------------------------------	--------------	-------------	----

D 2,5/5.NLL

- 1 circuit "neutral", blue marking
- 1 circuit "feed-through"

Spring block	grey V0 <input type="checkbox"/>	D 2,5/5.NLL	0290 330.15	40
--------------	----------------------------------	-------------	-------------	----

D 2,5/5.LLL

- 2 circuits "feed-through"

Spring block	grey V0 <input type="checkbox"/>	D 2,5/5.LLL	0290 328.17	40
--------------	----------------------------------	-------------	-------------	----

Accessories

End stop	V0	BADL	9 mm	0399 903.02	(screwless)	50
	light grey	BAM2	9.9 mm	0399 967.01	(with screw)	50
End section ①	grey V0 <input type="checkbox"/>	FED5.L.A	2,5 mm	0291 559.04		20
End section ③	grey V0 <input type="checkbox"/>	FED5.L.B	2,5 mm	0291 560.01		20
Jumper bar IP20 - 24 A	orange <input type="checkbox"/>	BJDL5.2	2 poles	0291 102.23		50
		BJDL5.3	3 poles	0291 103.24		50
		BJDL5.4	4 poles	0291 104.25		50
		BJDL5.5	5 poles	0291 105.26		50
		BJDL5.10	10 poles	0291 110.26		50

① For D 2,5/5.NTLPL only
 ② For D 2,5/5.NTLPL, D 2,5/5.NLPL, D 2,5/5.LLPL
 ③ For D 2,5/5.NLL and D 2,5/5.LLL
 ④ Except for D 2,5/5.NTLPL

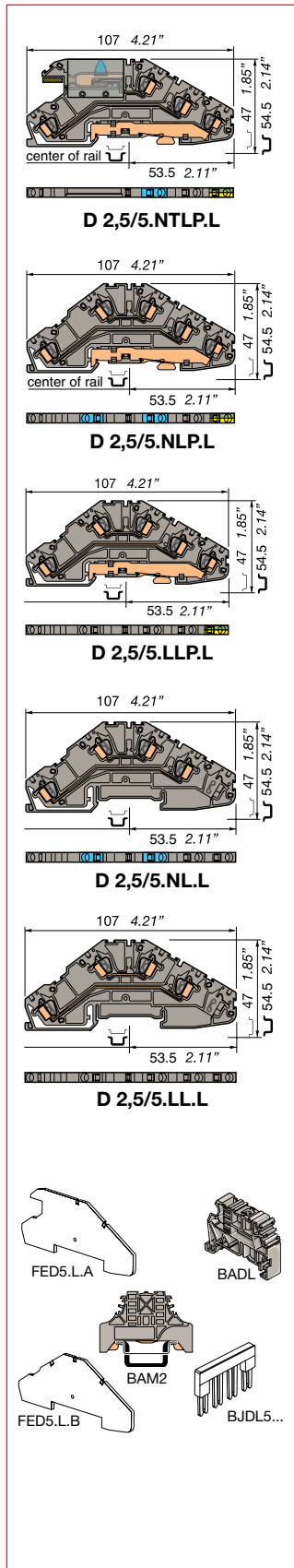

2

Switch for neutral conductor

Spring clamp, \sqcup DIN 3

D 2,5/5.NT.L - 2.5 mm² blocks - 5 mm .197" spacing

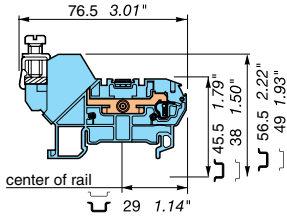

D 2,5/5.NT.L

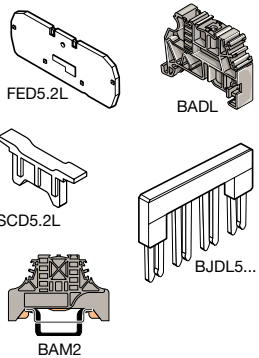

Characteristics		IEC NFC DIN	UL	CSA
Wire size (Screw clamp) mm ² / AWG	Solid	0.12 - 4 mm ²		
	Stranded	0.12 - 2.5 mm ²		
With isolated ferrule		0.5 - 2.5 mm ²		
Busbar		10 x 3 mm - .394" x .12"		
Voltage	V	400 V		
Pulse	kV	6 kV		
Current	A	24 A		
Rated wire size	mm ² / AWG	2.5 mm ² / A2		
Wire stripping length	mm / inches	9.5 mm / .374"		

Selection

Description	Type	Order P/N	Packaging
Terminal block, 1 spring Switch for neutral conductor			
blue	D 2,5/5.NT.L	0290 045.07	50

Accessories

End stop	V0	BADL	9 mm	0399 903.02	(screwless)	50
	light grey	BAM2	9.9 mm	0399 967.01	(with screw)	50
End section	grey V0	FED5.2L	2.5 mm	0291 061.24		20
	orange V0	FED5.2L	2.5 mm	0291 062.25		20
Separator	orange V0	SCD5.2L	2.5 mm	0291 352.04		20
Jumper bar IP 20 - 24 A	orange V0	BJDL5.2	2 poles	0291 102.23		50
		BJDL5.3	3 poles	0291 103.24		50
		BJDL5.4	4 poles	0291 104.25		50
		BJDL5.5	5 poles	0291 105.26		50
		BJDL5.10	10 poles	0291 110.26		50

D 4/6.NT.L - 4 mm² blocks - 6 mm .236" spacing

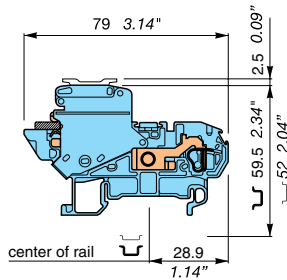

D 4/6.NT.L

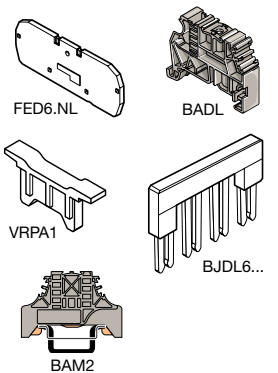

Characteristics		IEC NFC DIN	UL	CSA
Wire size (Screw clamp) mm ² / AWG	Solid	0.2 - 6 mm ²		
	Stranded	0.22 - 4 mm ²		
With isolated ferrule		10 x 3 mm - .394" x .12"		
Voltage	V	400 V		
Pulse	kV	6 kV		
Current	A	32 A		
Rated wire size	mm ² / AWG	4 mm ² / A4		
Wire stripping length	mm / inches	11 mm / .43"		

Selection

Description	Type	Order P/N	Packaging
Terminal block, 1 spring Switch for neutral conductor			
blue	D 4/6.NT.L	0399 586.24	50

Accessories

End stop	V0	BADL	9 mm	0399 903.02	(screwless)	50
	light grey	BAM2	9.9 mm	0399 967.01	(with screw)	50
End section	grey V0	FED6.NL	2.5 mm	0399 588.06		20
Separator	orange	VRPA1		0399 587.25		20
Jumper bar IP 20 - 32 A	orange V0	BJDL6.2	2 poles	0291 128.24		50
		BJDL6.3	3 poles	0291 129.25		50
		BJDL6.4	4 poles	0291 194.17		50
		BJDL6.5	5 poles	0291 195.10		50

Switch for neutral conductor

Spring clamp, \sqcup DIN 3



D 6/8.NT.L - 6 mm² blocks - 8 mm .315" spacing

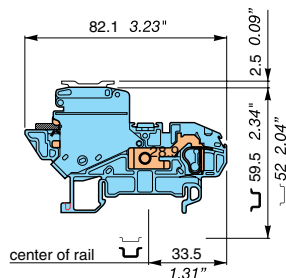

D 6/8.NT.L

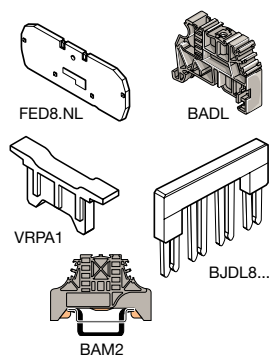

Characteristics

		IEC NFC DIN	UL	CSA
Wire size (Screw clamp) mm ² / AWG	Solid	0.5- 10 mm ²		
	Stranded	0.5 - 6 mm ²		
Busbar		10 x 3 mm - .394" x .12"		
Voltage	V	400 V		
Pulse	kV	6 kV		
Current	A	41 A		
Rated wire size	mm ² / AWG	6 mm ² / A5		
Wire stripping length	mm / inches	12.5 mm / .49"		

Selection

Description	Type	Order P/N	Packaging
Terminal block, 1 spring Switch for neutral conductor blue	D 6/8.NT.L	0399 589.07	50

Accessories

End stop	V0 light grey	BADL BAM2	9 mm 9.9 mm	0399 903.02 0399 967.01	(screwless) (with screw)	50 50
End section	grey V0	FED8.NL	2,5 mm	0399 590.04		20
Separator	orange	VRPA1		0399 587.25		20
Jumper bar IP 20 - 41 A	orange V0	BJD8.2 BJD8.3 BJD8.4 BJD8.5	2 poles 3 poles 4 poles 5 poles	0291 122.16 0291 123.17 0291 144.24 0291 145.25		50 50 50 50

D 10/10.NT.L - 10 mm² blocks - 10 mm .394" spacing

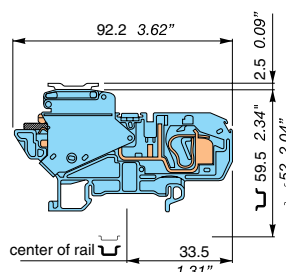

D 10/10.NT.L

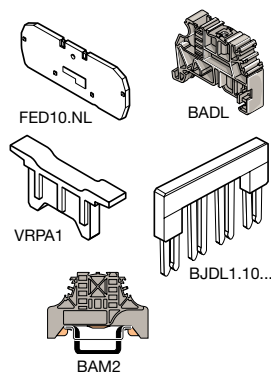

Characteristics

		IEC NFC DIN	UL	CSA
Wire size (Screw clamp) mm ² / AWG	Solid	0.5 - 16 mm ²		
	Stranded	0.5 - 10 mm ²		
With isolated ferrule		10 x 3 mm - .394" x .12"		
Voltage	V	400 V		
Pulse	kV	6 kV		
Current	A	57 A		
Rated wire size	mm ² / AWG	10 mm ² / A6		
Wire stripping length	mm / inches	12.5 mm / .49"		

Selection

Description	Type	Order P/N	Packaging
Terminal block, 1 spring Switch for neutral conductor blue	D 10/10.NT.L	0399 591.21	25

Accessories

End stop	V0 light grey	BADL BAM2	9 mm 9.9 mm	0399 903.02 0399 967.01	(screwless) (with screw)	50 50
End section	grey V0	FED10.NL	2,5 mm	0399 592.22		20
Separator	orange	VRPA1		0399 587.25		20
Jumper bar IP 20 - 57 A	orange V0	BJD1.10.2 BJD1.10.3 BJD1.10.4 BJD1.10.5	2 poles 3 poles 4 poles 5 poles	0291 472.25 0291 474.27 0291 476.21 0291 478.03		50 50 50 50

Heavy duty switch, terminal blocks with blade Spring clamp, U DIN 3

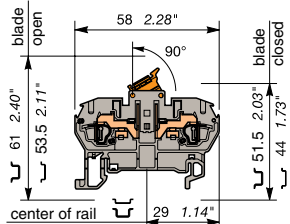

D 2,5/5.SNBT.2L

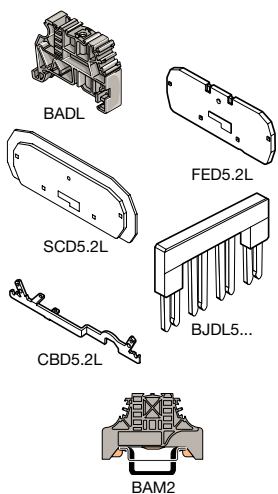

D 2,5/5.SNBT.2L - 2.5 mm² blocks - 5 mm .200" spacing

Characteristics

Wire size mm ² / AWG	Solid	IEC	UL	CSA
		NFC DIN		
mm ² / AWG	Stranded	0.12 - 4	26-12 AWG	26-12 AWG
	Isolated ferrules	0.5 - 2.5		
Voltage	V	500	600	600
Current	A	10	8	8
Rated wire size	mm ² / AWG	2.5 mm ²	12 AWG	12 AWG
Wire stripping length	mm / inches	9.5 mm / .37"		

Selection

Description	Type	Order P/N	Packaging	
Standard block grey/orange		D 2,5/5.SNBT.2L	0290 041.03	50
Standard block orange		D 2,5/5.SNBT.2L	0290 042.04	50

Accessories

Description	Type	Order P/N	Packaging		
End stop	BADL	9.0 mm	0399 903.02 (screwless)	50	
	BAM2	9.9 mm	0399 967.01 (with screw)	50	
End section	grey	FED5.2L	2.5 mm	0291 061.24	20
	orange	FED5.2L	2.5 mm	0291 062.25	20
Separator end section	orange	SCD5.2L	2.5 mm	0291 352.04	20
Assembled jumper bar (with IP20 protection)	2 poles	BJDL5.2	24 A	0291 102.23	50
	3 poles	BJDL5.3	24 A	0291 103.24	50
	4 poles	BJDL5.4	24 A	0291 104.25	50
	5 poles	BJDL5.5	24 A	0291 105.26	20
	10 poles	BJDL5.10	24 A	0291 110.26	20
Shield connector	CBD5.2L	0.5 mm	0291 077.24	50	

D 2,5/5.SNBT.4L - 2.5 mm² blocks - 5 mm .200" spacing

Characteristics

Wire size mm ² / AWG	Solid	IEC	UL	CSA
		NFC DIN		
mm ² / AWG	Stranded	0.12 - 4	26-12 AWG	26-12 AWG
	Isolated ferrules	0.5 - 2.5		
Voltage	V	500	600	600
Current	A	10	8	8
Rated wire size	mm ² / AWG	2.5 mm ²	12 AWG	12 AWG
Wire stripping length	mm / inches	9.5 mm / .37"		

Selection

Description	Type	Order P/N	Packaging	
Standard block grey		D 2,5/5.SNBT.4L	0290 133.24	50
Standard block grey/orange		D 2,5/5.SNBT.4L	0290 131.22	50
Standard block orange		D 2,5/5.SNBT.4L	0290 132.23	50
Standard block blue/orange		D 2,5/5.SNBT.N.4L	0290 134.25	50

Accessories

Description	Type	Order P/N	Packaging		
End stop	BADL	9 mm	0399 903.02 (screwless)	50	
	BAM2	9.9 mm	0399 967.01 (with screw)	50	
End section	grey	FED5.4L	2.5 mm	0291 041.20	20
	orange	FED5.4L	2.5 mm	0291 042.21	20
Separator end section	orange	SCD5.4L	2.5 mm	0291 372.00	20
Assembled jumper bar (with IP20 protection)	2 poles	BJDL5.2	24 A	0291 102.23	50
	3 poles	BJDL5.3	24 A	0291 103.24	50
	4 poles	BJDL5.4	24 A	0291 104.25	50
	5 poles	BJDL5.5	24 A	0291 105.26	20
	10 poles	BJDL5.10	24 A	0291 110.26	20

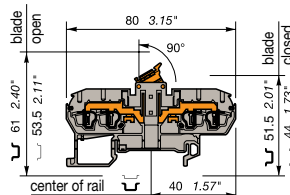

D 2,5/5.SNBT.4L

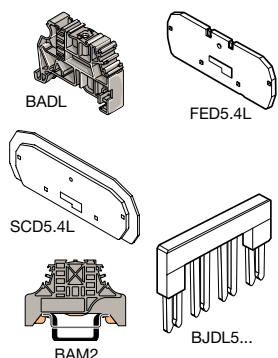

Fuse holder terminal blocks

5x20 mm .197x.787 in. and 5x25 mm .197x.984 in.
Spring clamp, U DIN 3

D 2,5/8.SFT.2L - 2.5 mm² blocks - 8 mm .315" spacing

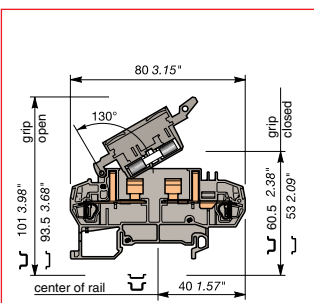

D 2,5/8.SFT.2L

Characteristics

Wire size mm ² / AWG	Solid Stranded isolated ferrules	IEC	UL	CSA
		NFC DIN		
		0.12 - 4	26-12 AWG	26-12 AWG
		0.12 - 2.5		
		0.5 - 2.5		
Voltage	V	630	600	600
Current	A	6.3	8	8
Rated wire size	mm ² / AWG	2.5 mm ²	12 AWG	12 AWG
Wire stripping length	mm / inches	9.5 mm / .37"		

Selection

Description	Type	Order P/N	Packaging
Standard block grey	<input type="checkbox"/> D 2,5/8.SFT.2L	0290 091.26	50
Standard block orange	<input type="checkbox"/> D 2,5/8.SFT.2L	0290 092.27	50

Accessories

End stop		BADL	9 mm	0399 903.02	(screwless)	50
	light grey	BAM2	9.9 mm	0399 967.01	(with screw)	50
End section	grey	<input type="checkbox"/> FED8SF.2L	3 mm	0291 131.17		20
	orange	<input type="checkbox"/> FED8SF.2L	3 mm	0291 132.10		20
Assembled jumper bar (with IP20 protection)	2 poles	BJDL8.2	24 A	0291 122.16		50
	3 poles	BJDL8.3	24 A	0291 123.17		50
	4 poles	BJDL8.4	24 A	0291 144.24		50
	5 poles	BJDL8.5	24 A	0291 145.25		20

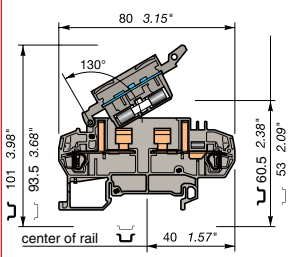
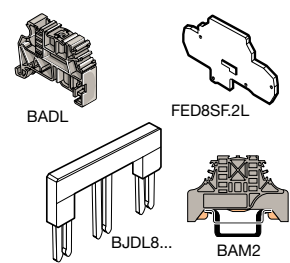

D 2,5/8.SF...T.2L

D 2,5/8.S...T.2L - 2.5 mm² blocks - 8 mm .315" spacing

Characteristics

Wire size mm ² / AWG	Solid Stranded isolated ferrules	IEC	UL	CSA
		NFC DIN		
		0.12 - 4	26-12 AWG	26-12 AWG
		0.12 - 2.5		
		0.5 - 2.5		
Voltage	V	630	600	600
Current	A	6.3	8	8
Rated wire size	mm ² / AWG	2.5 mm ²	12 AWG	12 AWG
Wire stripping length	mm / inches	9.5 mm / .37"		

Selection

Description	Type	Order P/N	Packaging
Block with test socket ①	grey <input type="checkbox"/>	D 2,5/8.SFLT.2L	0290 093.20
Block with test socket ②	grey <input type="checkbox"/>	D 2,5/8.SFDT.2L	0290 094.21
Block with test socket ③	grey <input type="checkbox"/>	D 2,5/8.SFD1T.2L	0290 095.22
Block with test socket grey body/blue lever	<input checked="" type="checkbox"/>	D 2,5/8.SNT.2L	0290 097.24

Accessories

End stop		BADL	9 mm	0399 903.02	(screwless)	50
	light grey	BAM2	9.9 mm	0399 967.01	(with screw)	50
End section	grey	<input type="checkbox"/> FED8SF.2L	3 mm	0291 131.17		20
	orange	<input type="checkbox"/> FED8SF.2L	3 mm	0291 132.10		20
Assembled jumper bar (with IP20 protection)	2 poles	BJDL8.2	24 A	0291 122.16		50
	3 poles	BJDL8.3	24 A	0291 123.17		50
	4 poles	BJDL8.4	24 A	0291 144.24		50
	5 poles	BJDL8.5	24 A	0291 145.25		20

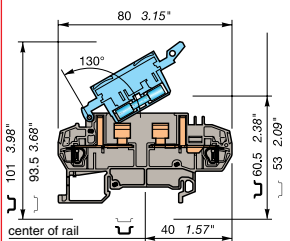

D 2,5/8.SNT.2L

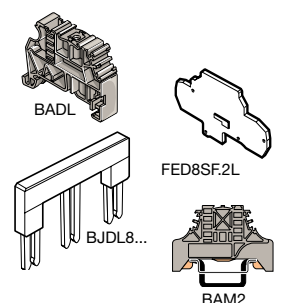

① Blown fuse indicator with neon lamp 110 V - 220 V
② Blown fuse indicator with LED 24 V
③ Blown fuse indicator with LED 48 V



Miniblocks

Base mount (snap-in or brackets)

Spring clamp, U DIN 3, U DIN 2



Optimal connection capacity
2.5 mm² (14 AWG) with an insulated ferrule, in 5 mm spacing.

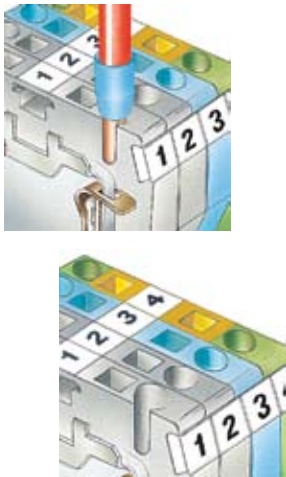

With an overall width of 33 mm, the mini blocks offer 2 connections with a 5 mm spacing and 4 connections with a 10 mm spacing.

Mini blocks designed for interconnection :

Entelec Mini blocks all have built-in interconnection facilities, so the connection terminals are reserved for connecting conductors.

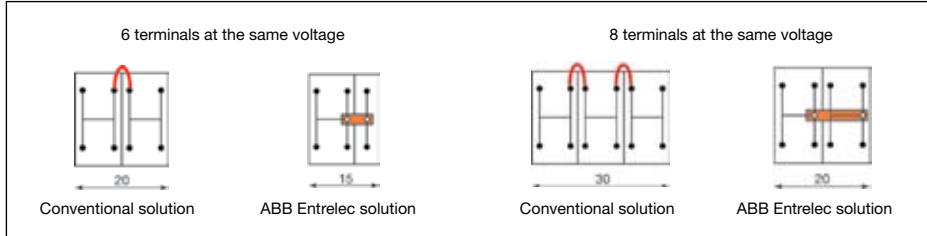

Numerous marking options :

- on the top of the blocks a marking card (up to 4 characters)
- an additional marking card (up to 4 characters) on each side of the blocks, to comply with specific requirements.

DIN 3 rail mounted

DS 2,5/5.2L or DS 2,5/10.4L

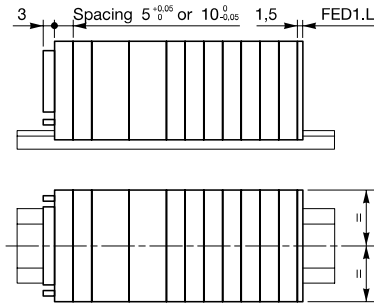

DIN 2 rail mounted

DR 2,5/5.2L or DR 2,5/10.4L

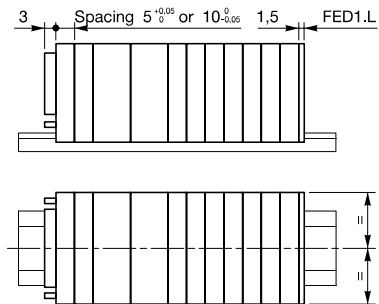

Panel mounted

Clip-on : DH 2,5/5.2L or DH 2,5/10.4L

With flanges : DB 2,5/5.2L or DB 2,5/10.4L

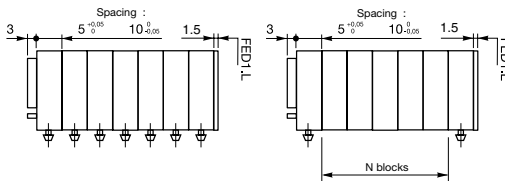

Drilling
(panel thickness : 0.6 to 1.2 mm
.024" to .047")

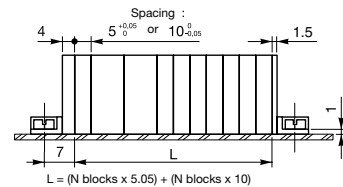
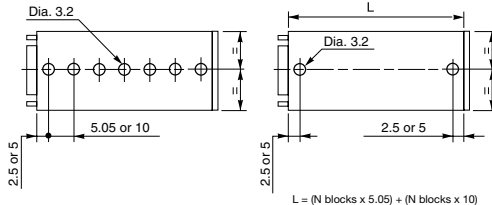

Drilling

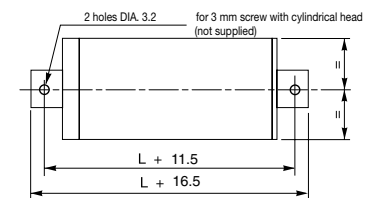

- * For 10 mm blocks, mount a DH block every 4 blocks.
- * For 5 mm blocks, mount a DH block every 8 blocks.

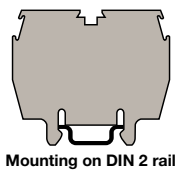
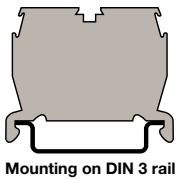

Miniblocks

Feed through

Spring clamp, \sqcup DIN 3



DS 2,5/5.2L - 2.5 mm² miniblocks - 5 mm .197" spacing - 2 springs

Characteristics

Wire size mm ² / AWG	Solid Stranded	IEC NFC DIN		UL/CSA
		0.12 - 4 mm ² ①	0.12 - 2.5 mm ²	
	Isolated ferrule	0.5 - 2.5 mm ²		
Voltage	V	800 V		600 V
Pulse	kV	8 kV		
Rated Current	A	24 A		15 A
Rated wire size / Gauge	mm ² / AWG	2.5 mm ² /A2		12 AWG
Wire stripping length	mm / inches	9.5 mm / .37"		
Recommended screwdriver	mm / inches	3.5 mm / .14"		

Selection

Description	Type	Order P/N	Packaging
2 spring miniblocks	grey <input type="checkbox"/>	DS 2,5/5.2L	0290 221.04
	orange <input type="checkbox"/>	DS 2,5/5.2L	0290 222.05
	blue <input type="checkbox"/>	DS 2,5/5.N.2L	0290 223.06

Accessories

Description	Type	Order P/N	Packaging
End stop	BADL 9 mm	0399 903.02	(screwless) 50
	BAM2 9.9 mm	0399 967.01	(with screw) 50
End section	grey V0 <input type="checkbox"/> FED1.L 1.5 mm	0291 301.02	20
	orange V0 <input type="checkbox"/> FED1.L 1.5 mm	0291 302.03	20
Jumper bar IP 20	orange V0 <input type="checkbox"/>		
	2 poles BJD5.2 24 A	0291 102.23	50
	3 poles BJD5.3 24 A	0291 103.24	50
	4 poles BJD5.4 24 A	0291 104.25	50
	5 poles BJD5.5 24 A	0291 105.26	50
	10 poles BJD5.10 24 A	0291 110.26	50

DS 2,5/10.4L - 2.5 mm² miniblocks - 10 mm .394" spacing - 4 springs

Characteristics

Wire size mm ² / AWG	Solid Stranded	IEC NFC DIN		UL/CSA
		0.12 - 4 mm ² ①	0.12 - 2.5 mm ²	
	Isolated ferrule	0.5 - 2.5 mm ²		
Voltage	V	800 V		600 V
Pulse	kV	8 kV		
Rated Current	A	24 A		15 A
Rated wire size / Gauge	mm ² / AWG	2.5 mm ² /A2		12 AWG
Wire stripping length	mm / inches	9.5 mm / .37"		
Recommended screwdriver	mm / inches	3.5 mm / .14"		

Selection

Description	Type	Order P/N	Packaging
4 spring miniblocks	grey <input type="checkbox"/>	DS 2,5/10.4L	0290 231.06
	orange <input type="checkbox"/>	DS 2,5/10.4L	0290 232.07
	blue <input type="checkbox"/>	DS 2,5/10.N.4L	0290 233.00

Accessories

Description	Type	Order P/N	Packaging
End stop	BADL 9 mm	0399 903.02	(screwless) 50
	BAM2 9.9 mm	0399 967.01	(with screw) 50
End section	grey V0 <input type="checkbox"/> FED1.L 1.5 mm	0291 301.02	20
	orange V0 <input type="checkbox"/> FED1.L 1.5 mm	0291 302.03	20
Jumper bar IP 20	orange V0 <input type="checkbox"/>		
	2 poles BJD10.2 24 A	0291 322.26	50
	3 poles BJD10.3 24 A	0291 323.27	50
	4 poles BJD10.4 24 A	0291 324.20	20
	5 poles BJD10.5 24 A	0291 325.21	20

① Spring miniblocks 5 mm spacing (DR 2,5/5.2L) comply with IEC 947-1 standard : rated wire size 1 to 2.5 mm². However, these blocks can be connected to 4 mm² solid wires.

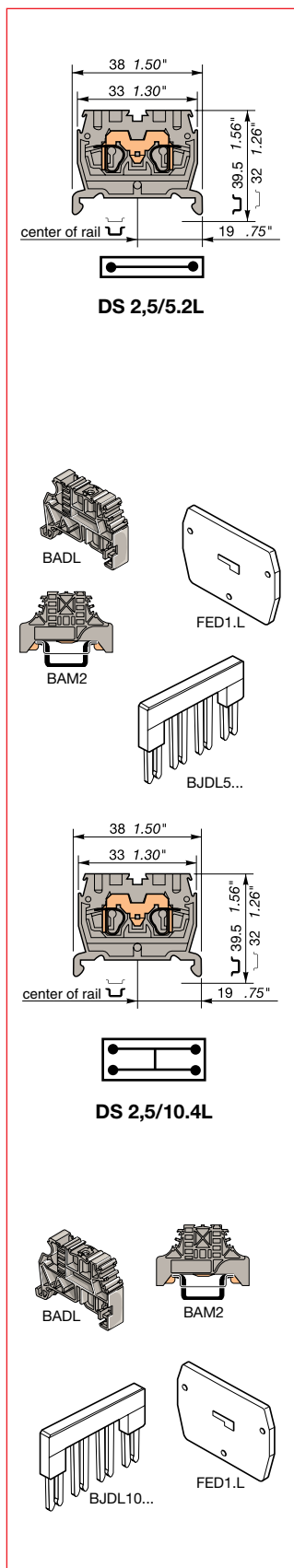

Miniblocks

Feed through

Spring clamp, U DIN 2

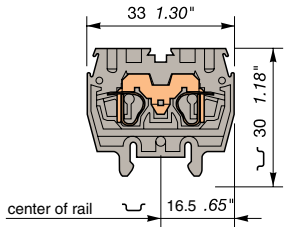

DR 2,5/5.2L

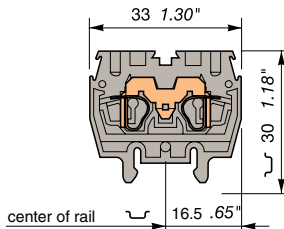

DR 2,5/10.4L

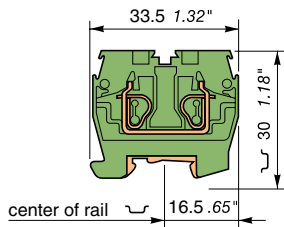
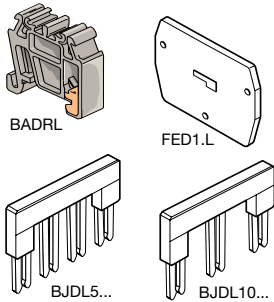

DR 2,5/10.P.4L

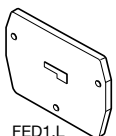

DR 2,5/5.2L - 2.5 mm² miniblocks - 5 mm .197" spacing - 2 springs
 DR 2,5/10.4L - 2.5 mm² miniblocks - 10 mm .394" spacing - 4 springs

Characteristics		IEC		UL/CSA
		NFC	DIN	
Wire size mm ² / AWG	Solid	0.12 - 4 mm ² ①		26-12 AWG
	Stranded	0.12 - 2.5 mm ²		
	Isolated ferrule	0.5 - 2.5 mm ²		
Voltage	V	800 V		600 V
Pulse	kV	8 kV		
Rated Current	A	24 A		15 A
Short circuit current (DR 2,5/...PI...L)	A/s	300 A/s		
Rated wire size / Gauge	mm ² / AWG	2.5 mm ² /A2		12 AWG
Wire stripping length	mm / inches	9.5 mm / .37"		
Recommended screwdriver	mm / inches	3.5 mm / .14"		

Selection

Description	Type	Order P/N	Packaging	
2 spring miniblocks	grey □	DR 2,5/5.2L	0290 201.11	100
	orange ■	DR 2,5/5.2L	0290 202.12	
	blue □	DR 2,5/5.N.2L	0290 203.13	
Ground block yellow body/ green marking (without rail contact)	■	DR 2,5/5.PI.2L	0290 210.15	100
4 spring miniblocks	grey □	DR 2,5/10.4L	0290 211.02	100
	orange ■	DR 2,5/10.4L	0290 212.03	
	blue □	DR 2,5/10.N.4L	0290 213.04	
Ground block yellow body/ green marking (without rail contact)	■	DR 2,5/10.PI.4L	0290 260.27	100

Accessories

End stop		BADR.L 6.5 mm	0199 420.21	50
End section V0	grey □	FED1.L 1.5 mm	0291 301.02	20
	orange ■	FED1.L 1.5 mm	0291 302.03	
Jumper bar IP 20 (for DR 2,5/5.2L)	orange ■	BJDL5.2 24 A	0291 102.23	50
		2 poles	BJDL5.3 24 A	50
		3 poles	BJDL5.4 24 A	50
		4 poles	BJDL5.5 24 A	50
		5 poles	BJDL5.1024 A	50
		10 poles	BJDL5.1024 A	50
Jumper bar IP 20 (for DR 2,5/10.4L)	orange ■	BJDL10.224 A	0291 322.26	50
		2 poles	BJDL10.324 A	50
		3 poles	BJDL10.424 A	20
		4 poles	BJDL10.524 A	20
		5 poles	BJDL10.524 A	20

DR 2,5/10.P.4L - 2.5 mm² protection miniblock - 10 mm .394" spacing - 4 springs

Characteristics		IEC		UL/CSA
		NFC	DIN	
Wire size mm ² / AWG	Solid	0.12 - 4 mm ² ①		26-12 AWG
	Stranded	0.12 - 2.5 mm ²		
	Short-circuit current	A / s	300 A / 1 s.	
Rated wire size / Gauge	mm ² / AWG	2.5 mm ² /A2		12 AWG
Wire stripping length	mm / inches	9.5 mm / .37"		
Recommended screwdriver	mm / inches	3.5 mm / .14"		

Selection

Description	Type	Order P/N	Packaging	
4 spring protection miniblock, green body / yellow marking connected to the mounting rail	■	DR 2,5/10.P.4L	0290 219.12	100

Accessories

End section V0	grey □	FED1.L 1.5 mm	0291 301.02	20
	orange ■	FED1.L 1.5 mm	0291 302.03	20

① Spring miniblocks 5 mm spacing (DR 2,5/5.2L) comply with IEC 947-1 standard : rated wire size 1 to 2.5 mm². However, these blocks can be connected to 4 mm² solid wires.

Miniblocks

Base mount with snap-in mounting foot

Spring clamp

DH 2,5/5.2L - 2.5 mm² miniblocks - 5 mm .197" spacing - 2 springs

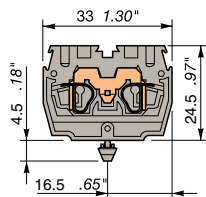

DH 2,5/5.2L

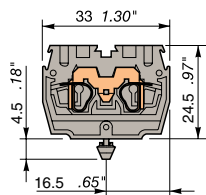
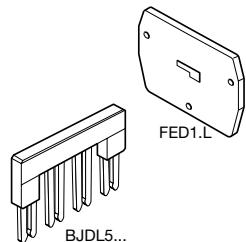

DH 2,5/10.4L

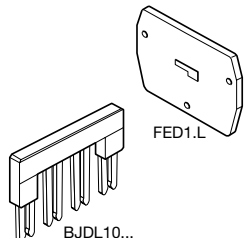

Characteristics		IEC		UL/CSA
		NFC	DIN	
Wire size mm ² / AWG	Solid	0.12 - 4 mm ² ①		26-12 AWG
	Stranded	0.12 - 2.5 mm ²		
	Isolated ferrule	0.5 - 2.5 mm ²		
Voltage	V	800 V	600 V	
Pulse	kV	8 kV		
Rated Current	A	24 A	15 A	
Rated wire size / Gauge	mm ² / AWG	2.5 mm ² /A2	12 AWG	
Wire stripping length	mm / inches	9.5 mm / .37"		
Recommended screwdriver	mm / inches	3.5 mm / .14"		

Selection

Description	Type	Order P/N	Packaging	
2 spring miniblocks	grey <input type="checkbox"/>	DH 2,5/5.2L	0290 261.14	100
	orange <input type="checkbox"/>	DH 2,5/5.2L	0290 262.15	100
	blue <input type="checkbox"/>	DH 2,5/5.N.2L	0290 263.16	100

Accessories

End section	grey V0 <input type="checkbox"/>	FED1.L 1.5 mm	0291 301.02	20	
	orange V0 <input type="checkbox"/>	FED1.L 1.5 mm	0291 302.03	20	
Jumper bar IP 20	orange V0 <input type="checkbox"/>				
		2 poles	BJDL5.2 24 A	0291 102.23	50
		3 poles	BJDL5.3 24 A	0291 103.24	50
		4 poles	BJDL5.4 24 A	0291 104.25	50
		5 poles	BJDL5.5 24 A	0291 105.26	50
		10 poles	BJDL5.1024 A	0291 110.26	50

DH 2,5/10.4L - 2.5 mm² miniblocks - 10 mm .394" spacing - 4 springs

Characteristics		IEC		UL/CSA
		NFC	DIN	
Wire size mm ² / AWG	Solid	0.12 - 4 mm ² ①		26-12 AWG
	Stranded	0.12 - 2.5 mm ²		
	Isolated ferrule	0.5 - 2.5 mm ²		
Voltage	V	800 V	600 V	
Pulse	kV	8 kV		
Rated Current	A	24 A	15 A	
Rated wire size / Gauge	mm ² / AWG	2.5 mm ² /A2	12 AWG	
Wire stripping length	mm / inches	9.5 mm / .37"		
Recommended screwdriver	mm / inches	3.5 mm / .14"		

Selection

Description	Type	Order P/N	Packaging	
4 spring miniblocks	grey <input type="checkbox"/>	DH 2,5/10.4L	0290 271.16	100
	orange <input type="checkbox"/>	DH 2,5/10.4L	0290 272.17	100
	blue <input type="checkbox"/>	DH 2,5/10.N.4L	0290 273.10	100

Accessories

End section	grey V0 <input type="checkbox"/>	FED1.L 1.5 mm	0291 301.02	20	
	orange V0 <input type="checkbox"/>	FED1.L 1.5 mm	0291 302.03	20	
Jumper bar IP 20	orange V0 <input type="checkbox"/>				
		2 poles	BJDL10.2 24 A	0291 322.26	50
		3 poles	BJDL10.3 24 A	0291 323.27	50
		4 poles	BJDL10.4 24 A	0291 324.20	20
		5 poles	BJDL10.5 24 A	0291 325.21	20

① Spring miniblocks 5 mm spacing (DR 2,5/5.2L) comply with IEC 947-1 standard : rated wire size 1 to 2.5 mm². However, these blocks can be connected to 4 mm² solid wires.

Miniblock

Base mount with flanges

Spring clamp

DB 2,5/5.2L - 2.5 mm² miniblocks - 5 mm .197" spacing - 2 springs

Characteristics

		IEC		UL/CSA
		NFC	DIN	
Wire size mm ² / AWG	Solid	0.12 - 4 mm ² ①		26-12 AWG
	Stranded	0.12 - 2.5 mm ²		
	Isolated ferrule	0.5 - 2.5 mm ²		
Voltage	V	800 V		600 V
Pulse	kV	8 kV		
Rated Current	A	24 A		15 A
Rated wire size / Gauge	mm ² / AWG	2.5 mm ² /A2		12 AWG
Wire stripping length	mm / inches	9.5 mm / .37"		
Recommended screwdriver	mm / inches	3.5 mm / .14"		

Selection

Description	Type	Order P/N	Packaging
2 spring miniblocks	grey <input type="checkbox"/>	DB 2,5/5.2L	0290 241.10
	orange <input type="checkbox"/>	DB 2,5/5.2L	0290 242.11
	blue <input type="checkbox"/>	DB 2,5/5.N.2L	0290 243.12

Accessories

End section kit (right + left)	grey V0 <input type="checkbox"/>	FEDB.L 1.5 mm	0290 281.01	20
	orange V0 <input type="checkbox"/>	FEDB.L 1.5 mm	0290 282.02	20
Jumper bar IP 20	orange V0 <input type="checkbox"/>			
	2 poles	BJDL5.2 24 A	0291 102.23	50
	3 poles	BJDL5.3 24 A	0291 103.24	50
	4 poles	BJDL5.4 24 A	0291 104.25	50
	5 poles	BJDL5.5 24 A	0291 105.26	50
10 poles	BJDL5.1024 A	0291 110.26	50	

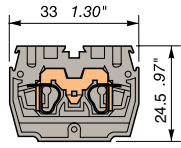

DB 2,5/5.2L

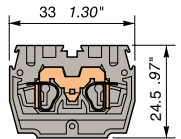
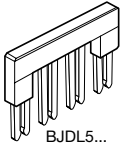
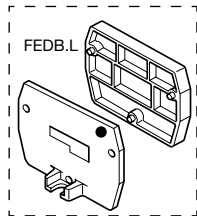

DB 2,5/10.4L

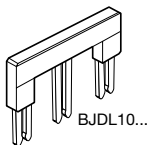
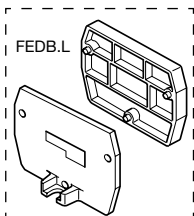

DB 2,5/10.4L - 2.5 mm² miniblocks - 10 mm .394" spacing - 4 springs

Characteristics

		IEC		UL/CSA
		NFC	DIN	
Wire size mm ² / AWG	Solid	0.12 - 4 mm ² ①		26-12 AWG
	Stranded	0.12 - 2.5 mm ²		
	Isolated ferrule	0.5 - 2.5 mm ²		
Voltage	V	800 V		600 V
Pulse	kV	8 kV		
Rated Current	A	24 A		15 A
Rated wire size / Gauge	mm ² / AWG	2.5 mm ² /A2		12 AWG
Wire stripping length	mm / inches	9.5 mm / .37"		
Recommended screwdriver	mm / inches	3.5 mm / .14"		

Selection

Description	Type	Order P/N	Packaging
4 spring miniblocks	grey <input type="checkbox"/>	DB 2,5/10.4L	0290 251.12
	orange <input type="checkbox"/>	DB 2,5/10.4L	0290 252.13
	blue <input type="checkbox"/>	DB 2,5/10.N.4L	0290 253.14

Accessories

End section kit (right + left)	grey V0 <input type="checkbox"/>	FEDB.L 1.5 mm	0290 281.01	20
	orange V0 <input type="checkbox"/>	FEDB.L 1.5 mm	0290 282.02	20
Jumper bar IP 20	orange V0 <input type="checkbox"/>			
	2 poles	BJDL10.224 A	0291 322.26	50
	3 poles	BJDL10.324 A	0291 323.27	50
	4 poles	BJDL10.424 A	0291 324.20	20
5 poles	BJDL10.524 A	0291 325.21	20	

① Spring miniblocks 5 mm spacing (DR 2,5/5.2L) comply with IEC 947-1 standard : rated wire size 1 to 2.5 mm². However, these blocks can be connected to 4 mm² solid wires.



Feed through and ground terminal blocks

Insulation displacement

ADO - Screw clamp, Ω DIN 3

ADO Screw clamp

D 2,5/5.ADO - 1 mm² blocks - 5 mm .198" spacing

Characteristics

Wire size mm ² / AWG	Screw	Solid Stranded	IEC	UL	CSA
			NFC DIN		
	ADO	Solid	0.2 - 4	22-12 AWG	22-12 AWG
		Stranded	0.22 - 2.5		
	ADO	Solid	0.2 - 1	24-18 AWG	24-18 AWG
		Stranded	0.22 - 1		
Voltage		V	1000	600	600
Current		A	13.5	7	7
Short circuit current (D2,5/5PI.ADO)		A / s	120 A/1s		
Rated wire size		mm ² / AWG	1 mm ²	18 AWG	18 AWG
Wire stripping length (screw)		mm / inches	9.5 mm / .37"		
Recommended torque (screw)		Nm / lb.in	0.4-0.6 / 3.5-5.3 lb.in		

2 wires of the same gauge and nature per ADO connection

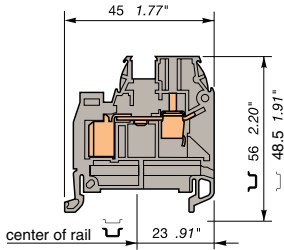

D 2,5/5.ADO

Selection

Description	Type	Order P/N	Packaging
Standard block grey	<input type="checkbox"/> D 2,5/5.ADO	0199 554.23	50
Standard block orange	<input type="checkbox"/> D 2,5/5.ADO	0199 555.24	50
Standard block blue	<input type="checkbox"/> D 2,5/5.N.ADO	0199 556.25	50
Standard block black	<input type="checkbox"/> D 2,5/5.ADO	0199 557.26	50
Standard block red	<input type="checkbox"/> D 2,5/5.ADO	0199 558.07	50
Standard block yellow	<input type="checkbox"/> D 2,5/5.ADO	0199 560.05	50
Standard block ivory	<input type="checkbox"/> D 2,5/5.ADO	0199 559.00	50
Standard block green	<input type="checkbox"/> D 2,5/5.ADO	0199 561.22	50
Ground block yellow body/ green marking (without rail contact)	<input type="checkbox"/> D 2,5/5.PI.ADO	0399 181.26	50

Accessories

Description	Type	Order P/N	Packaging
End stop	BADL 9 mm	0399 903.02	50 (screwless)
	light grey BAM2 9.9 mm	0399 967.01	50 (with screw)
End section	grey <input type="checkbox"/> FEDAD1 3 mm	0199 336.20	20
	blue <input type="checkbox"/> FEDAD1 3 mm	0199 338.02	20
	yellow <input type="checkbox"/> FEDAD1 3 mm	0199 339.03	20
Assembled jumper bar (with IP20 protection)	2 poles BJMI5 24 A	0176 278.16	10
	3 poles BJMI5 24 A	0176 279.17	10
	4 poles BJMI5 24 A	0176 280.05	10
	5 poles BJMI5 24 A	0176 281.22	10
	10 poles BJMI5 24 A	0176 282.23	10
Shield connector	CBM5 0.5 mm	0178 745.14	50
	CBM8 0.8 mm	0178 746.15	50

3

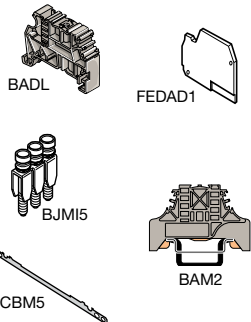

D 2,5/5.PADO - 1 mm² ground block with rail contact - 5 mm .198" spacing

Characteristics

Wire size mm ² / AWG	Screw	Solid Stranded	IEC	UL	CSA
			NFC DIN		
	ADO	Solid	0.2 - 4	22-12AWG	22-12AWG
		Stranded	0.22 - 2.5		
	ADO	Solid	0.2 - 1	24-18AWG	24-18AWG
		Stranded	0.22 - 1		
Short circuit current		A / s	120 A/1s		
Rated wire size		mm ² / AWG	1 mm ²	18AWG	18AWG
Wire stripping length (screw)		mm / inches	9.5 mm / .37"		
Recommended torque (screw)		Nm / lb.in	0.4-0.6 Nm / 3.5-5.3 lb.in		

2 wires of the same gauge and nature per ADO connection

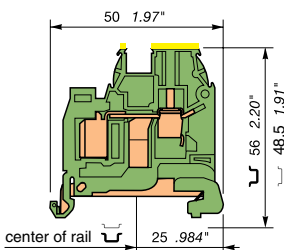

D 2,5/5.PADO

Selection

Description	Type	Order P/N	Packaging
Ground block V0 green/yellow	<input type="checkbox"/> D 2,5/5.PADO	0399 030.05	50

Accessories

Description	Type	Order P/N	Packaging
End section	grey <input type="checkbox"/> FEDAD1 3 mm	0199 336.20	20
	yellow <input type="checkbox"/> FEDAD1 3 mm	0199 339.03	20

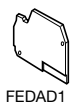



Feed through and ground terminal blocks

Insulation displacement

ADO - Screw clamp, U DIN 3

D 4/6... .ADO - 1.5 mm² blocks - 6 mm .238" spacing

Characteristics

Wire size mm ² / AWG	Screw	Solid	IEC	UL	CSA
			NFC DIN		
		Stranded	0.22 - 4	22-10 AWG	22-10 AWG
		Solid	0.34 - 1.5		
	ADO	Stranded	0.34 - 1.5	22-16 AWG	22-16 AWG
		Solid	0.34 - 1.5		
Voltage	V		1000	600	600
Current	A		17.5	18	18
Short circuit current (D4/6.PI.ADO)	A / s		180 A/1s		
Rated wire size	mm ² / AWG		1.5 mm ²	16 AWG	16 AWG
Wire stripping length (screw)	mm / inches		9.5 mm / .37"		
Recommended torque (screw)	Nm / lb.in		0.5-0.8 / 4.4-7.1 lb.in		

2 wires of the same gauge and nature per ADO connection

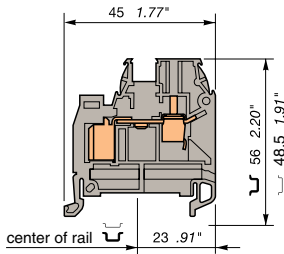

D 4/6... .ADO

Selection

Description	Type	Order P/N	Packaging
Standard block grey	□ D 4/6.ADO	0199 034.15	50
Standard block orange	■ D 4/6.ADO	0199 035.16	50
Standard block blue	■ D 4/6.N.ADO	0199 036.17	50
Standard block black	■ D 4/6.ADO	0199 071.22	50
Standard block red	■ D 4/6.ADO	0199 069.00	50
Standard block yellow	■ D 4/6.ADO	0199 039.22	50
Standard block ivory	□ D 4/6.ADO	0199 070.05	50
Standard block green	■ D 4/6.ADO	0199 040.07	50
Ground block yellow body/ green marking (without rail contact)	■ D 4/6.PI.ADO	0199 037.10	50

Accessories

End stop	light grey	BADL	9 mm	0399 903.02	(screwless)	50
		BAM2	9.9 mm	0399 967.01	(with screw)	50
End section	grey	□ FEDAD1	3 mm	0199 336.20		20
	blue	■ FEDAD1	3 mm	0199 338.02		20
	yellow	■ FEDAD1	3 mm	0199 339.03		20
Assembled jumper bar (with IP20 protection)	2 poles	BJMI6	32 A	0176 663.00		10
	3 poles	BJMI6	32 A	0176 664.01		10
	4 poles	BJMI6	32 A	0176 665.02		10
	5 poles	BJMI6	32 A	0176 666.03		10
	10 poles	BJMI6	32 A	0176 667.04		10
Shielding connector		CBM5	0.5 mm	0178 745.14		50
		CBM8	0.8 mm	0178 746.15		50

D 4/6.P.ADO - 1.5 mm² ground block with rail contact - 6 mm .238" spacing

Characteristics

Wire size mm ² / AWG	Screw	Solid	IEC	UL	CSA
			NFC DIN		
		Stranded	0.22 - 4	22-10AWG	22-10AWG
		Solid	0.34 - 1.5		
	ADO	Stranded	0.34 - 1.5	22-16AWG	22-16AWG
		Solid	0.34 - 1.5		
Short circuit current	A / s		180 A/1s		
Rated wire size	mm ² / AWG		1.5 mm ²	16AWG	16AWG
Wire stripping length (screw)	mm / inches		9.5 mm / .37"		
Recommended torque (screw)	Nm / lb.in		0.5-0.8 Nm / 4.4-7.1 lb.in		

2 wires of the same gauge and nature per ADO connection

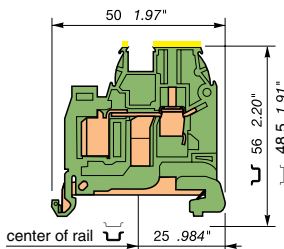

D 4/6.P.ADO

Selection

Description	Type	Order P/N	Packaging
Ground block green body/ yellow marking V0	■ D 4/6.P.ADO	0199 050.01	50

Accessories

End section	yellow	■ FEDAD1	3 mm	0199 339.03	20
	grey	□ FEDAD1	3 mm	0199 336.20	20



FEDAD1



Feed through and ground terminal blocks

Insulation displacement

ADO - Screw clamp, \mathcal{U} DIN 3



D 6/8... .ADO - 2.5 mm² blocks - 8 mm .315" spacing

Characteristics

		IEC		UL	CSA
		NFC	DIN		
Wire size mm ² / AWG	Screw	Solid	0.2 - 10	22-8 AWG	22- 8 AWG
		Stranded	0.22 - 6		
	ADO	Solid	1 - 2.5	16-14 AWG	16-14 AWG
		Stranded	1 - 2.5		
Voltage	V	1000	600	600	
Current	A	24	25	25	
Short circuit current (D6/8.PI.ADO)	A / s	300 A/1s			
Rated wire size	mm ² / AWG	2.5 mm ²	14 AWG	14 AWG	
Wire stripping length (screw)	mm / inches	12 mm / .47"			
Recommended torque (screw)	Nm / lb.in	0.8-1 Nm / 7.1-8.9 lb.in			

2 wires of the same gauge and nature per ADO connection

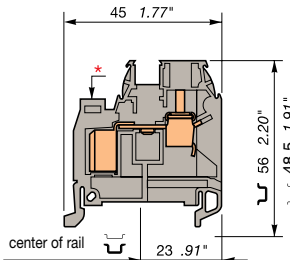

D 6/8... .ADO

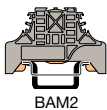

BAM2

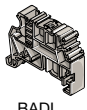

BADL



FEDAD1



BJMI8

Selection

Description	Type	Order P/N	Packaging
Standard block grey	<input type="checkbox"/> D 6/8.ADO	0199 042.25	50
Standard block orange	<input type="checkbox"/> D 6/8.ADO	0199 043.26	50
Standard block blue	<input type="checkbox"/> D 6/8.N.ADO	0199 044.27	50
Standard block black	<input type="checkbox"/> D 6/8.ADO	0199 077.20	50
Standard block red	<input type="checkbox"/> D 6/8.ADO	0199 075.26	50
Standard block yellow	<input type="checkbox"/> D 6/8.ADO	0199 072.23	50
Standard block ivory	<input type="checkbox"/> D 6/8.ADO	0199 076.27	50
Standard block green	<input type="checkbox"/> D 6/8.ADO	0199 073.24	50
Ground block yellow body/ green marking (without rail contact)	<input type="checkbox"/> D 6/8.PI.ADO	0199 045.20	50

Accessories

End stop		BADL	9 mm	0399 903.02	(screwless)	50
	light grey	BAM2	9.9 mm	0399 967.01	(with screw)	50
End section	grey	<input type="checkbox"/> FEDAD1	3 mm	0199 336.20		20
	blue	<input type="checkbox"/> FEDAD1	3 mm	0199 338.02		20
	yellow	<input type="checkbox"/> FEDAD1	3 mm	0199 339.03		20
Assembled jumper bar (with IP20 protection)	2 poles	BJMI8	41 A	0176 669.16		10
	3 poles	BJMI8	41 A	0176 670.13		10
	4 poles	BJMI8	41 A	0176 671.00		10
	5 poles	BJMI8	41 A	0176 672.01		10
	10 poles	BJMI8	41 A	0176 673.02		10

D 6/8.P.ADO - 2.5 mm² ground block with rail contact - 8 mm .315" spacing

Characteristics

		IEC		UL	CSA
		NFC	DIN		
Wire size mm ² / AWG	Screw	Solid	0.2 - 10	22-8AWG	22-8AWG
		Stranded	0.22 - 6		
	ADO	Solid	1 - 2.5	16-14AWG	16-14AWG
		Stranded	1 - 2.5		
Short circuit current	A / s	300 A/1s			
Rated wire size	mm ² / AWG	2.5 mm ²	14AWG	14AWG	
Wire stripping length (screw)	mm / inches	12 mm / .47"			
Recommended torque (screw)	Nm / lb.in	0.8-1 Nm / 7.1-8.9 lb.in			

2 wires of the same gauge and nature per ADO connection

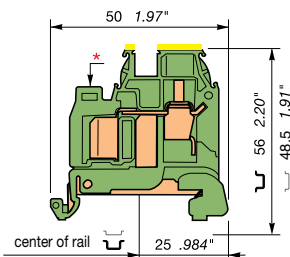

D 6/8.P.ADO



FEDAD1

Selection

Description	Type	Order P/N	Packaging
Ground block green body/ yellow marking V0	<input type="checkbox"/> D 6/8.P.ADO	0199 118.26	50

Accessories

End section	yellow	<input type="checkbox"/> FEDAD1	3 mm	0199 339.03	20
	grey	<input type="checkbox"/> FEDAD1	3 mm	0199 336.20	20

Feed through and ground terminal blocks

Insulation displacement

ADO - Screw clamp, U DIN 3

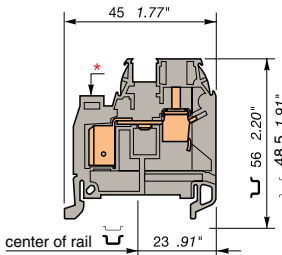

D 6/8.ADO3

D 6/8.ADO3 - 4 mm² blocks - 8 mm .315" spacing

Characteristics

Wire size mm ² / AWG	Screw	IEC		UL	CSA
		NFC	DIN		
		Solid	0.2 - 10	22-8 AWG	22- 8 AWG
		Stranded	0.22 - 6		
	ADO	Solid	4	14-12 AWG	14-12 AWG
		Stranded	4		
Voltage		V	1000	600	600
Current		A	32	50	25
Short circuit current (D6/8.PI.ADO3)		A / s	480 A/1s		
Rated wire size		mm ² / AWG	4 mm ²	12 AWG	12 AWG
Wire stripping length (screw)		mm / inches	12 mm / .47"		
Recommended torque (screw)		Nm / lb.in	0.8-1 Nm / 7.1-8.9 lb.in		

Only 1 wire per ADO connection

Selection

Description	Type	Order P/N	Packaging
Standard block grey	<input type="checkbox"/> D 6/8.ADO3	0399 245.15	50
Standard block orange	<input type="checkbox"/> D 6/8.ADO3	0399 800.17	50
Standard block blue	<input type="checkbox"/> D 6/8.N.ADO3	0399 319.17	50
Ground block yellow body/ green marking (without rail contact)	<input type="checkbox"/> D 6/8.PI.ADO3	0399 273.11	50

Accessories

End stop	light grey	BADL	9 mm	0399 903.02	(screwless)	50
		BAM2	9.9 mm	0399 967.01	(with screw)	50
End section	grey	<input type="checkbox"/> FEDAD1	3 mm	0199 336.20		20
	blue	<input type="checkbox"/> FEDAD1	3 mm	0199 338.02		20
	yellow	<input type="checkbox"/> FEDAD1	3 mm	0199 339.03		20
Assembled jumper bar (with IP20 protection)	2 poles	BJMI8	41 A	0176 669.16		10
	3 poles	BJMI8	41 A	0176 670.13		10
	4 poles	BJMI8	41 A	0176 671.00		10
	5 poles	BJMI8	41 A	0176 672.01		10
	10 poles	BJMI8	41 A	0176 673.02		10

D 6/8.P.ADO3 - 4 mm² ground block with rail contact - 8 mm .315" spacing

Characteristics

Wire size mm ² / AWG	Screw	IEC		UL	CSA
		NFC	DIN		
		Solid	0.2 - 10	22-8AWG	22-8AWG
		Stranded	0.22 - 6		
	ADO	Solid	4	14-12 AWG	14-12 AWG
		Stranded	4		
Short circuit current		A / s	480 A/1s		
Rated wire size		mm ² / AWG	4 mm ²	12 AWG	12 AWG
Wire stripping length (screw)		mm / inches	12 mm / .47"		
Recommended torque (screw)		Nm / lb.in	0.8-1 Nm / 7.1-8.9 lb.in		

Only 1 wire per ADO connection

Selection

Description	Type	Order P/N	Packaging
Ground block green body/ yellow marking	<input type="checkbox"/> D 6/8.P.ADO3	0399 251.13	50

Accessories

End section	yellow	<input type="checkbox"/> FEDAD1	3 mm	0199 339.03	20
	grey	<input type="checkbox"/> FEDAD1	3 mm	0199 336.20	20

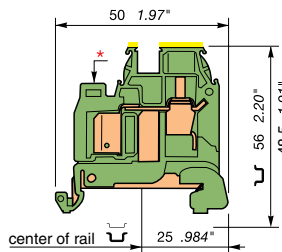

D 6/8.P.ADO3



FEDAD1



Feed through and ground terminal blocks

Insulation displacement - Double deck

ADO - Screw clamp, U DIN 3



D 4/6.D2.ADO - 1.5 mm² blocks - 6 mm .238" spacing

Characteristics

		IEC NFC DIN	UL	CSA
Wire size mm ² / AWG	Screw	Solid 0.2 - 4 Stranded 0.22 - 4	22-10 AWG	22-10 AWG
	ADO	Solid 0.28 - 1.5 Stranded 0.34 - 1.5	22-16 AWG	22-16 AWG
Voltage	V	800	600	600
Current	A	17.5	18	18
Short-circuit current (D 4/6.D1.PADO)	A/s	180 A/s		
Rated wire size	mm ² / AWG	1.5 mm ²	16AWG	16AWG
Wire stripping length (screw)	mm / inches	9.5 mm / .37"		
Recommended torque (screw)	Nm / lb.in	0.5-0.8 Nm / 4.4-7.1 lb.in		

2 wires of the same gauge and nature per ADO connection

Selection

Description	Type	Order P/N	Packaging
Standard block grey	<input type="checkbox"/> D 4/6.D2.ADO	0199 242.02	50
Standard block orange	<input type="checkbox"/> D 4/6.D2.ADO	0199 243.03	50
Standard block blue	<input type="checkbox"/> D 4/6.D2.N.ADO	0199 262.06	50
Standard block green	<input type="checkbox"/> D 4/6.D2.ADO	0199 262.06	50
Ground block green body/ yellow marking with rail contact	<input type="checkbox"/> D 4/6.D1.PADO	0399 931.25	50

Accessories

End stop		BAMH 9.1 mm BADH 12 mm	0114 836.00 0116 900.27	50 50
End section	grey	<input type="checkbox"/> FED2AD1 5 mm	0199 417.12	20
Assembled jumper bar (with IP20 protection)	2 poles 3 poles 4 poles 5 poles 10 poles	BJMI6 32 A BJMI6 32 A BJMI6 32 A BJMI6 32 A BJMI6 32 A	0176 663.00 0176 664.01 0176 665.02 0176 666.03 0176 667.04	10 10 10 10 10
Shield connector		CBD2S	0178 408.14	50

D 6/8.D2.ADO - 2.5 mm² blocks - 8 mm .315" spacing

Characteristics

		IEC NFC DIN	UL	CSA
Wire size mm ² / AWG	Screw	Solid 0.2 - 10 Stranded 0.22 - 6		
	ADO	Solid 1 - 2.5 Stranded 1 - 2.5		
Voltage	V	800		
Current	A	24		
Rated wire size	mm ² / AWG	2.5 mm ²		
Wire stripping length (screw)	mm / inches	12 mm / .47"		
Recommended torque (screw)	Nm / lb.in	0.8 - 1 Nm / 7.1 - 8.9 lb.in		

2 wires of the same gauge and nature per ADO connection

Selection

Description	Type	Order P/N	Packaging
Standard block grey	<input type="checkbox"/> D 4/6.D2.ADO	0399 600.26	50
Standard block blue	<input type="checkbox"/> D 4/6.D2.N.ADO	0399 602.14	50

Accessories

End stop		BAMH 9.1 mm BADH 12 mm	0114 836.00 0116 900.27	50 50
End section	grey	<input type="checkbox"/> FED2AD1 5 mm	0199 417.12	20
Assembled jumper bar (with IP20 protection)	2 poles 3 poles 4 poles 5 poles 10 poles	BJMI8 41 A BJMI8 41 A BJMI8 41 A BJMI8 41 A BJMI8 41 A	0176 669.16 0176 670.13 0176 671.00 0176 672.01 0176 673.02	10 10 10 10 10

Ⓢ Except for blocks D 4/6.D1.PADO

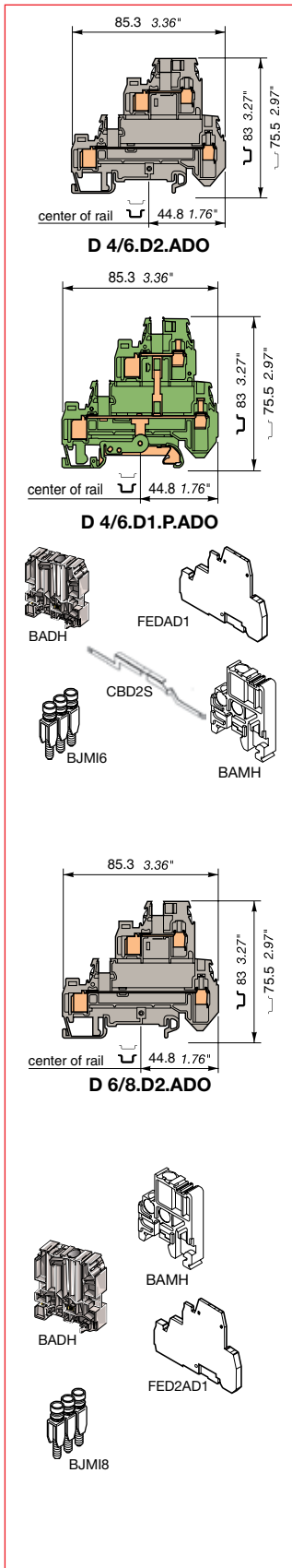

3



Heavy duty switch terminal blocks with blade

Insulation displacement

ADO - Screw clamp, U DIN 3

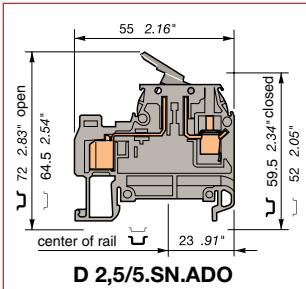

D 2,5/5.SN.ADO - 1 mm² blocks - 5 mm .198" spacing

Characteristics

		IEC NFC DIN		UL	CSA
Wire size mm ² / AWG	Screw	Solid	0.2 - 4	22-12 AWG	22-12AWG
		Stranded	0.22 - 2.5		
	ADO	Solid	0.2 - 1	24-18 AWG	24-18 AWG
		Stranded	0.22 - 1		
Voltage	V	320	300	300	
Current	A	10			
Rated wire size	mm ² / AWG	1 mm ²	18AWG	18AWG	
Wire stripping length (screw)	mm / inches	9.5 mm / .37"			
Recommended torque (screw)	Nm / lb.in	0.4-0.6 Nm / 3.5-5.3 lb.in			

2 wires of the same gauge and nature per ADO connection

Selection

Description	Type	Order P/N	Packaging
Standard block grey	<input type="checkbox"/> D 2,5/5.SN.ADO	0399 226.02	50
Standard block orange	<input type="checkbox"/> D 2,5/5.SN.ADO	0399 227.03	50

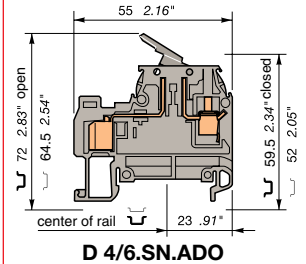

D 4/6.SN.ADO - 1.5 mm² blocks - 6 mm .238" spacing

Characteristics

		IEC NFC DIN		UL	CSA
Wire size mm ² / AWG	Screw	Solid	0.2 - 4	22-10 AWG	22-10AWG
		Stranded	0.22 - 4		
	ADO	Solid	0.34 - 1.5	22-16 AWG	22-16 AWG
		Stranded	0.34 - 1.5		
Voltage	V	500	600	600	
Current	A	10	10	10	
Rated wire size	mm ² / AWG	1.5 mm ²	16AWG	16AWG	
Wire stripping length (screw)	mm / inches	9.5 mm / .37"			
Recommended torque (screw)	Nm / lb.in	0.5-0.8 Nm / 4.4-7.1 lb.in			

2 wires of the same gauge and nature per ADO connection

Selection

Description	Type	Order P/N	Packaging
Standard block grey	<input type="checkbox"/> D 4/6.SN.ADO	0199 107.24	50
Standard block orange	<input type="checkbox"/> D 4/6.SN.ADO	0199 108.05	50

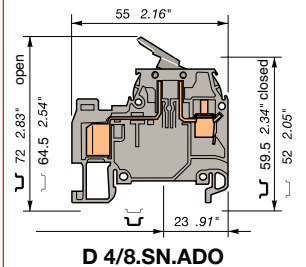

D 4/8.SN.ADO - 2.5 mm² blocks - 8 mm .315" spacing

Characteristics

		IEC NFC DIN		UL	CSA
Wire size mm ² / AWG	Screw	Solid	0.2 - 6	22-10 AWG	22-10AWG
		Stranded	0.22 - 4		
	ADO	Solid	1 - 2.5	16-14 AWG	16-14 AWG
		Stranded	1 - 2.5		
Voltage	V	500	600	600	
Current	A	15	15	15	
Rated wire size	mm ² / AWG	2.5 mm ²	14AWG	14AWG	
Wire stripping length (screw)	mm / inches	9.5 mm / .37"			
Recommended torque (screw)	Nm / lb.in	0.5-0.8 Nm / 4.4-7.1 lb.in			

2 wires of the same gauge and nature per ADO connection

Selection

Description	Type	Order P/N	Packaging
Standard block grey	<input type="checkbox"/> D 4/8.SN.ADO	0199 137.11	50
Standard block orange	<input type="checkbox"/> D 4/8.SN.ADO	0199 138.22	50

Accessories

End stop	light grey	BADL	9 mm	0399 903.02	(screwless)	50
		BAM2	9.9 mm	0399 967.01	(with screw)	50
End section	grey	<input type="checkbox"/> FEDAD4	2 mm	0199 352.00		20
Shield connector		CBD1	0.8 mm	0179 634.06		1
Screwless jumper bar orange IP20	2 poles	BJADO5.2	13.5 A	0205 955.03		20
		BJADO5.3	13.5 A	0205 956.04		20
		BJADO5.4	13.5 A	0205 957.05		20
		BJADO5.5	13.5 A	0205 958.16		20
		BJADO5.10	13.5 A	0205 963.03		10
		Screwless jumper bar orange IP20	2 poles	BJADO6.2	17.5 A	0205 974.06
BJADO6.3	17.5 A			0205 975.07		20
BJADO6.4	17.5 A			0205 976.00		20
BJADO6.5	17.5 A			0205 977.01		20
BJADO6.10	17.5 A			0205 982.27		10

① Except for D 4/8.SN.ADO

② Only for D 2,5/5.SN.ADO

③ Only for D 4/6.SN.ADO

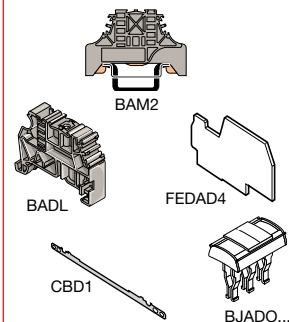



Fuse holder terminal blocks

5x20 mm .197x.787 in. and 5x25 mm .197x.984 in.
ADO - Screw clamp, \sqcup DIN 3

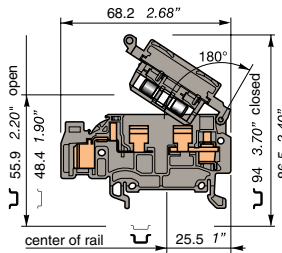

D 4/8.SF...I.ADO

D 4/8.SF...I.ADO - 1.5 mm² blocks - 8 mm .315" spacing

Characteristics

		IEC NFC DIN		UL	CSA
Wire size mm ² / AWG	Screw	Solid	0.2 - 4	22-10AWG	22-10AWG
		Stranded	0.22 - 4		
	ADO	Solid	0.34 - 1.5	22-16 AWG	22-16 AWG
		Stranded	0.34 - 1.5		
Voltage		V	630 ①	600 ①	600 ①
Current		A	6.3	10	10
Rated wire size		mm ² / AWG	1.5 mm ²	16AWG	16AWG
Wire stripping length (screw)		mm / inches	9.5 mm / .37"		
Recommended torque (screw)		Nm / lb.in	0.5-0.8 Nm / 4.4-7.1 lb.in		

2 wires of the same gauge and nature per ADO connection

Selection

Description	Type	Order P/N	Packaging
Standard block grey <input type="checkbox"/>	D 4/8.SF.I.ADO	0399 785.03	50
Standard block orange <input type="checkbox"/>	D 4/8.SF.I.ADO	0399 786.04	50
Bloc with Ø 2 mm test socket grey <input type="checkbox"/>	D 4/8.SFT2.I.ADO	0399 777.12	50

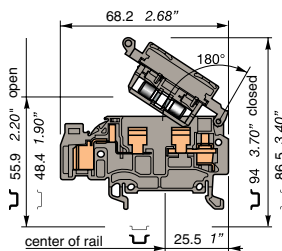

D 4/8.SFL...I.ADO

D 4/8.SFL...I.ADO - 1.5 mm² blocks - 8 mm .315" spacing

Characteristics

		IEC NFC DIN		UL	CSA
Wire size mm ² / AWG	Screw	Solid	0.2 - 4	22-10AWG	22-10AWG
		Stranded	0.22 - 4		
	ADO	Solid	0.34 - 1.5	22-16 AWG	22-16 AWG
		Stranded	0.34 - 1.5		
Voltage		V	500	600	600
Current		A	6.3	10	10
Rated wire size		mm ² / AWG	1.5 mm ²	16AWG	16AWG
Wire stripping length (screw)		mm / inches	9.5 mm / .37"		
Recommended torque (screw)		Nm / lb.in	0.5-0.8 Nm / 4.4-7.1 lb.in		

2 wires of the same gauge and nature per ADO connection

Selection

Description	Type	Order P/N	Packaging
Standard block grey ② <input type="checkbox"/>	D 4/8.SFL.I.ADO	0399 780.12	50
Standard block grey ③ <input type="checkbox"/>	D 4/8.SFD.I.ADO	0399 781.07	50

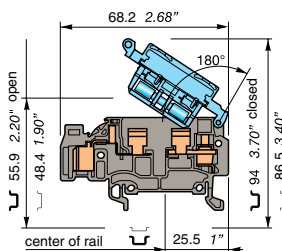

D 4/8.SNN.I.ADO

D 4/8.SNN.I.ADO - 1.5 mm² blocks - 8 mm .315" spacing - neutral switch block

Characteristics

		IEC NFC DIN		UL	CSA
Wire size mm ² / AWG	Screw	Solid	0.2 - 4	22-10AWG	22-10AWG
		Stranded	0.22 - 4		
	ADO	Solid	0.34 - 1.5	22-16 AWG	22-16 AWG
		Stranded	0.34 - 1.5		
Voltage		V	630	600	600
Current		A	10	10	10
Rated wire size		mm ² / AWG	1.5 mm ²	10/16AWG	10/16AWG
Wire stripping length (screw)		mm / inches	9.5 mm / .37"		
Recommended torque (screw)		Nm / lb.in	0.5-0.8 Nm / 4.4-7.1 lb.in		

2 wires of the same gauge and nature per ADO connection

Selection

Description	Type	Order P/N	Packaging
Standard block grey body/ blue grip <input type="checkbox"/>	D 4/8.SNN.I.ADO	0399 778.23	50

Accessories

End stop		BADL	9 mm	0399 903.02	(screwless)	50
	light grey	BAM2	9.9 mm	0399 967.01	(with screw)	50
End section	grey <input type="checkbox"/>	FEDAD10	1.5 mm	0399 758.27		20

- ① Terminal block insulation voltage. Working voltage according to fuse.
- ② Blown-fuse indicator by 110 V - 230 V neon lamp (leakage current with neon lamp : < 0,5 mA (110 V) - < 0,7 mA (230 V)).
- ③ Blown-fuse indicator by LED 24 V (+24V labeled) (leakage current with LED 24 V or 48 V < 4,5 mA).

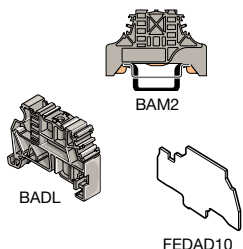

Fuse holder terminal blocks

5x20 mm .197x.787 in. and 5x25 mm .197x.984 in.

ADO - Screw clamp, DIN 3

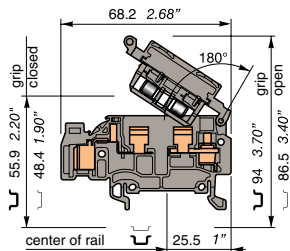

D 4/8.SF...I.ADO2

D 4/8.SF...I.ADO2 - 2.5 mm² blocks - 8 mm .315" spacing

Characteristics

		IEC		UL	CSA
		NFC	DIN		
Wire size mm ² / AWG	Screw	Solid	0.2 - 4	22-10AWG	22-10AWG
		Stranded	0.22 - 4		
	ADO	Solid	1 - 2.5	16-14 AWG	16-14 AWG
		Stranded	1 - 2.5		
Voltage	V	630 ①	600 ①	600 ①	
Current	A	6.3	10	10	
Rated wire size	mm ² / AWG	1.5 mm ²	10/14AWG	10/14AWG	
Wire stripping length (screw)	mm / inches	9.5 mm / .37"			
Recommended torque (screw)	Nm / lb.in	0.5-0.8 Nm / 4.4-7.1 lb.in			

2 wires of the same gauge and nature per ADO connection

Selection

Description	Type	Order P/N	Packaging
Standard block grey	<input type="checkbox"/> D 4/8.SF.I.ADO2	0399 763.14	50
Standard block orange	<input type="checkbox"/> D 4/8.SF.I.ADO2	0399 764.15	50
Block with Ø 2 mm screw side grey	<input type="checkbox"/> D 4/8.SFT2.I.ADO2	0399 762.13	50

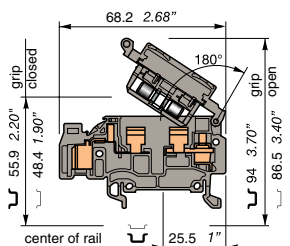

D 4/8.SF...I.ADO2

D 4/8.SF...I.ADO2 - 2.5 mm² blocks - 8 mm .315" spacing

Characteristics

		IEC		UL	CSA
		NFC	DIN		
Wire size mm ² / AWG	Screw	Solid	0.2 - 4	22-10AWG	22-10AWG
		Stranded	0.22 - 4		
	ADO	Solid	1 - 2.5	16-14 AWG	16-14 AWG
		Stranded	1 - 2.5		
Voltage	V	500 ①	600 ①	600 ①	
Current	A	6.3	10	10	
Rated wire size	mm ² / AWG	2.5 mm ²	10/14AWG	10/14AWG	
Wire stripping length (screw)	mm / inches	9.5 mm / .37"			
Recommended torque (screw)	Nm / lb.in	0.5-0.8 Nm / 4.4-7.1 lb.in			

Selection

Description	Type	Order P/N	Packaging
Standard block grey ②	<input type="checkbox"/> D 4/8.SFL.I.ADO2	0399 767.10	50
Standard block grey ③	<input type="checkbox"/> D 4/8.SFD.I.ADO2	0399 769.22	50

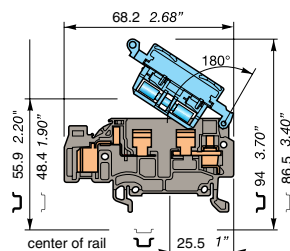

D 4/8.SNN.I.ADO2

D 4/8.SNN.I.ADO2 - 2.5 mm² blocks - 8 mm .315" spacing - neutral switch block

Characteristics

		IEC		UL	CSA
		NFC	DIN		
Wire size mm ² / AWG	Screw	Solid	0.2 - 4	22-10AWG	22-10AWG
		Stranded	0.22 - 4		
	ADO	Solid	1 - 2.5	16-14 AWG	16-14 AWG
		Stranded	1 - 2.5		
Voltage	V	630	600	600	
Current	A	6.3	10	10	
Rated wire size	mm ² / AWG	1.5 mm ²	10/14AWG	10/14AWG	
Wire stripping length (screw)	mm / inches	9.5 mm / .37"			
Recommended torque (screw)	Nm / lb.in	0.5-0.8 Nm / 4.4-7.1 lb.in			

2 wires of the same gauge and nature per ADO connection

Selection

Description	Type	Order P/N	Packaging
Standard block grey body/ blue grip	<input type="checkbox"/> D 4/8.SNN.I.ADO2	0399 765.16	50

Accessories

End stop		BADL	9 mm	0399 903.02	(screwless)	50
	light grey	BAM2	9.9 mm	0399 967.01	(with screw)	50
End section	grey	<input type="checkbox"/> FEDAD10	1.5 mm	0399 758.27		20

① Terminal block insulation voltage. Working voltage according to fuse.

② Blown-fuse indicator by 110 V - 230 V neon lamp (leakage current with neon lamp < 0.5 mA (110 V) - < 0.7 mA (230 V)).

③ Blown-fuse indicator by LED 24 V (+24V labeled) (leakage current with LED 24 V or 48 V < 4.5 mA).

Miniblock mounting and accessories

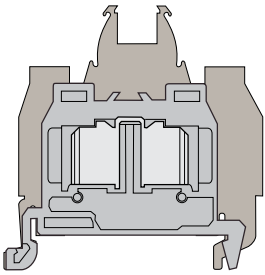

A reduced size range

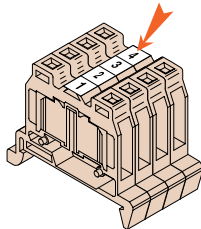

A very legible marking

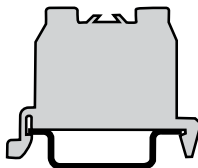

DS=DIN3
Mounting on DIN 3 rail

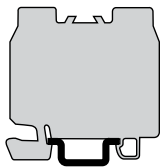

DR=DIN2
Mounting on DIN 2 rail

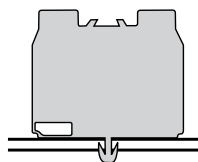

DH = snap-in

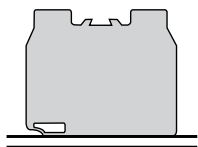

DB = flanges
Panel mounting

Rail mounting DIN 2 and DIN 3

DIN 2 : DR...ADO - DIN 3 : DS...ADO

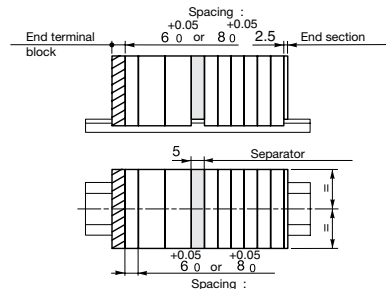

At the end of the terminal block assembly :

- End section : (same accessory for any type of terminal block assembly)

FEAD1 : V/ADO
FEAD2 : ADO/ADO

End section to be mounted directly on the open part of the terminal block.

- End terminal block :

DRE... ADO (DIN2)

This terminal block has to be mounted at the end of the terminal block DSE... ADO (DIN3) assembly : it reduces its size, because it suppresses the insulation rib (- 4 mm).

Note : This terminal block cannot be accidentally located anywhere else into the terminal block assembly (without locking holes).

In the terminal block assembly :

- Separator : (same accessory for any type of terminal terminal block assembly)

FEAD5 : V/ADO
FEAD6 : ADO/ADO

Accessory which snaps on the terminal blocks, separates and makes visible the different parts of the terminal block assembly.

Base mounting

Snap on : DH...ADO

With flanges : DB...ADO

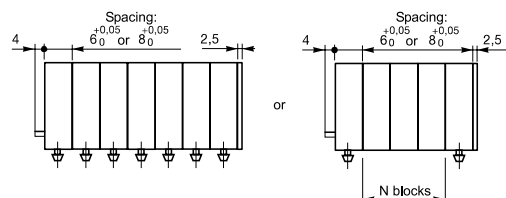

Drilling (plate thickness 0.6 mm to 1.2 mm)

N blocks = 3 blocks max. with 6 mm spacing
2 blocks max. with 8 mm spacing

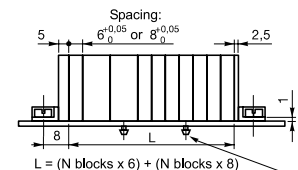
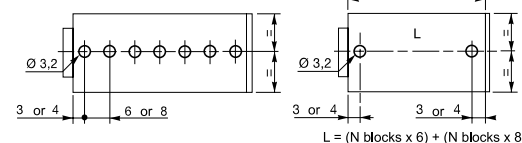

Drilling (plate thickness 0.6 to 1.2 mm)

2 holes Ø 3.2 for 3 mm screw max. with cylindrical head (not provided)

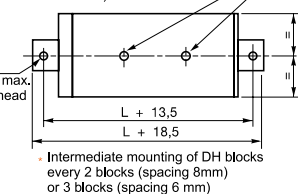

Intermediate mounting of DH blocks every 2 blocks (spacing 8mm) or 3 blocks (spacing 6 mm)



Miniblocks

Feed through

ADO - Screw clamp, \sqcup DIN 3

DS 4/6.ADO - 1.5 mm² miniblocks - 6 mm .236" spacing

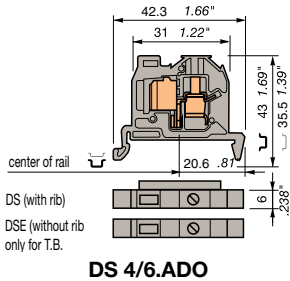

		Screw	IEC		UL/CSA
			NFC	DIN	
Wire size mm ² / AWG		Solid	0.2 - 4 mm ²		22-10 AWG
			Stranded		
	ADO	Solid	0.28 - 1.5 mm ²		22-16 AWG
			Stranded		
Voltage		V	800 V		600 V
Pulse		kV			
Current		A	17.5 A		20 A
Rated wire size		mm ² / AWG	1.5 mm ²		16-10 AWG
Wire stripping length		mm / inches	9.5 mm / .374"		
Recommended torque (screw)		Nm / lb.in	0.5-0.8 Nm / 4.4-7.1 lb.in		

2 wires of the same gauge and nature per ADO connection

Selection

Description	Type	Order P/N	Packaging
DIN 3 miniblocks	grey <input type="checkbox"/>	DS 4/6.ADO	0299 489.07
	blue <input type="checkbox"/>	DS 4/6.N.ADO	0299 491.21
	orange <input type="checkbox"/>	DS 4/6.ADO	0299 490.04
	grey <input type="checkbox"/>	DSE 4/6.ADO	0299 556.01

Accessories

End stop V0		BADL	9 mm	0399 903.02	(screwless)	50
	light grey	BAM2	9.9 mm	0399 967.01	(with screw)	50
End section V0	grey <input type="checkbox"/>	FEAD1	2.5 mm	0199 421.16		20
	orange <input type="checkbox"/>	FEAD1	2.5 mm	0199 422.17		20
Screwless jumper bar IP 20	orange <input type="checkbox"/>					
	2 poles	BJADO6.2	17.5 A	0205 974.06		20
	3 poles	BJADO6.3	17.5 A	0205 975.07		20
	4 poles	BJADO6.4	17.5 A	0205 976.00		20
	5 poles	BJADO6.5	17.5 A	0205 977.01		20
	10 poles	BJADO6.10	17.5 A	0205 982.27		10

DS 4/8.ADO - 2.5 mm² miniblocks - 8 mm .315" spacing

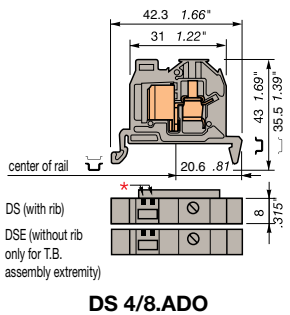

		Screw	IEC		UL/CSA
			NFC	DIN	
Wire size mm ² / AWG		Solid	0.2 - 4 mm ²		22-10 AWG
			Stranded		
	ADO	Solid	1 - 2.5 mm ²		16-14 AWG
			Stranded		
Voltage		V	1000 V		600 V
Pulse		kV			
Current		A	24 A		25 A
Rated wire size		mm ² / AWG	2.5 mm ²		14-10 AWG
Wire stripping length		mm / inches	9.5 mm / .374"		
Recommended torque (screw)		Nm / lb.in	0.5-0.8 Nm / 4.4-7.1 lb.in		

2 wires of the same gauge and nature per ADO connection

Selection

Description	Type	Order P/N	Packaging
DIN 3 miniblocks	grey <input type="checkbox"/>	DS 4/8.ADO	0299 493.23
	blue <input type="checkbox"/>	DS 4/8.N.ADO	0299 495.25
	orange <input type="checkbox"/>	DS 4/8.ADO	0299 494.24
	grey <input type="checkbox"/>	DSE 4/8.ADO	0299 557.02

* Notches to identify 8 mm spacing

Accessories

End stop V0		BADL	9 mm	0399 903.02	(screwless)	50
	light grey	BAM2	9.9 mm	0399 967.01	(with screw)	50
End section V0	grey <input type="checkbox"/>	FEAD1	2.5 mm	0199 421.16		20
	orange <input type="checkbox"/>	FEAD1	2.5 mm	0199 422.17		20
Comb-type jumper bar	2 poles	PC8	50 A	0116 538.17		10
	3 poles	PC8	50 A	0116 539.10		10
	4 poles	PC8	50 A	0116 540.25		10
	10 poles	PC8	50 A	0163 313.24		10

DR 4/6.ADO - 1.5 mm² miniblocks - 6 mm .236" spacing

Characteristics

Wire size mm ² / AWG	Screw	IEC		UL/CSA
		NFC	DIN	
		Solid	0.2 - 4 mm ²	22-10 AWG
		Stranded	0.22 - 4 mm ²	
	ADO	Solid	0.28 - 1.5 mm ²	22-16 AWG
		Stranded	0.34 - 1.5 mm ²	
Voltage	V	800 V	600 V	
Pulse	kV	8 kV		
Current	A	17.5 A	20 A	
Rated wire size	mm ² / AWG	1.5 mm ²	16 AWG	
Wire stripping length	mm / inches	9.5 mm / .374"		
Recommended torque (screw)	Nm / lb.in	0.5-0.8 Nm / 4.4-7.1 lb.in		

2 wires of the same gauge and nature per ADO connection

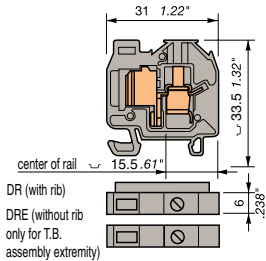

DR 4/6.ADO

Selection

Description	Type	Order P/N	Packaging	
DIN 2 miniblocks	grey <input type="checkbox"/>	DR 4/6.ADO	0199 275.03	100
	blue <input type="checkbox"/>	DR 4/6.N.ADO	0199 277.05	100
	orange <input type="checkbox"/>	DR 4/6.ADO	0199 276.04	100
	grey <input type="checkbox"/>	DRE 4/6.ADO	0299 552.05	20

DR 4/8...ADO - 2.5 mm² miniblocks - 8 mm .315" spacing

Characteristics

Wire size mm ² / AWG	Screw	IEC		UL/CSA
		NFC	DIN	
		Solid	0.2 - 4 mm ²	22-10 AWG
		Stranded	0.22 - 4 mm ²	
	ADO	Solid	1 - 2.5 mm ²	16-14 AWG
		Stranded	1 - 2.5 mm ²	
Voltage	V	1000 V ①	600 V ①	
Pulse	kV	8 kV ①		
Current	A	24 A ①	25 A ①	
Short-circuit current	A / s	300 A / 1 s ②		
Rated wire size	mm ² / AWG	2.5 mm ²	14 AWG	
Wire stripping length	mm / inches	9.5 mm / .374"		
Recommended torque (screw)	Nm / lb.in	0.5-0.8 Nm / 4.4-7.1 lb.in		

2 wires of the same gauge and nature per ADO connection

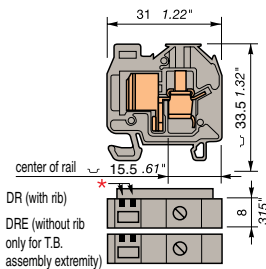

DR 4/8.ADO

Selection

Description	Type	Order P/N	Packaging	
DIN 2 miniblocks	grey <input type="checkbox"/>	DR 4/8.ADO	0199 279.17	100
	blue <input type="checkbox"/>	DR 4/8.N.ADO	0199 281.22	100
	orange <input type="checkbox"/>	DR 4/8.ADO	0199 280.05	100
	grey <input type="checkbox"/>	DRE 4/8.ADO	0299 553.06	20
	DIN 2 miniblock for ground wire connected to the mounting rail green body / yellow marking	<input type="checkbox"/>	DR 4/8.P.ADO	0299 632.05

Accessories

End stop	BADRL	6.5 mm	0199 420.21	50	
End section	grey V0 <input type="checkbox"/>	FEAD1	2.5 mm	0199 421.16	20
	orange V0 <input type="checkbox"/>	FEAD1	2.5 mm	0199 422.17	20
Screwless jumper bar IP 20 ④	orange <input type="checkbox"/>	2 poles	BJADO6.2 17.5 A	0205 974.06	20
		3 poles	BJADO6.3 17.5 A	0205 975.07	20
		4 poles	BJADO6.4 17.5 A	0205 976.00	20
		5 poles	BJADO6.5 17.5 A	0205 977.01	20
		10 poles	BJADO6.10 17.5 A	0205 982.27	10
		Comb-type jumper bar ③ ⑤		2 poles	PC8 50 A
3 poles	PC8 50 A			0116 539.10	10
4 poles	PC8 50 A			0116 540.25	10
10 poles	PC8 50 A			0163 313.24	10

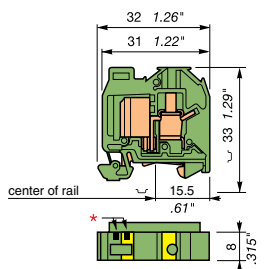

DR 4/8.P.ADO

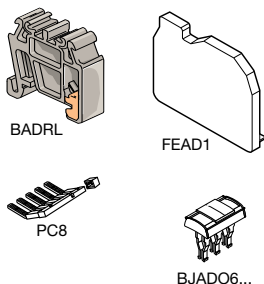

① Except for DR 4/8.P.ADO
 ② Only for DR 4/8.P.ADO
 ③ Except for DR 4/8.P.ADO
 ④ Except for DR 4/8...ADO
 ⑤ Except for DR 4/6...ADO

Miniblocks

Base mount with snap-in mounting foot ADO - Screw clamp

DH 4/6.ADO - 1.5 mm² miniblocks - 6 mm .236" spacing

Characteristics		IEC NFC DIN		UL/CSA
Wire size mm ² / AWG	Screw	Solid	0.2 - 4 mm ²	22-10 AWG
		Stranded	0.22 - 4 mm ²	
	ADO	Solid	0.28 - 1.5 mm ²	22-16 AWG
		Stranded	0.34 - 1.5 mm ²	
Voltage	V	800 V	600 V	
Pulse	kV	8 kV		
Current	A	17.5 A	20 A	
Rated wire size	mm ² / AWG	1.5 mm ²	16 AWG	
Wire stripping length	mm / inches	9.5 mm / .374"		
Recommended torque (screw)	Nm / lb.in	0.5-0.8 Nm / 4.4-7.1 lb.in		

2 wires of the same gauge and nature per ADO connection

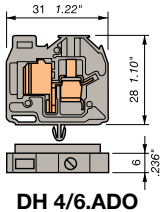

DH 4/6.ADO

Selection

Description	Type	Order P/N	Packaging	
Base mount miniblocks	grey <input type="checkbox"/>	DH 4/6.ADO	0299 521.26	100
with snap-in mounting	blue <input type="checkbox"/>	DH 4/6.N.ADO	0299 523.20	100
foot	orange <input type="checkbox"/>	DH 4/6.ADO	0299 522.27	100

Accessories

End section	grey V0 <input type="checkbox"/>	FEAD1	2.5 mm	0199 421.16	20
	orange V0 <input type="checkbox"/>	FEAD1	2.5 mm	0199 422.17	20
Screwless jumper bar IP 20	orange <input type="checkbox"/>				
	2 poles	BJADO6.2	17.5 A	0205 974.06	20
	3 poles	BJADO6.3	17.5 A	0205 975.07	20
	4 poles	BJADO6.4	17.5 A	0205 976.00	20
	5 poles	BJADO6.5	17.5 A	0205 977.01	20
10 poles	BJADO6.10	17.5 A	0205 982.27	10	

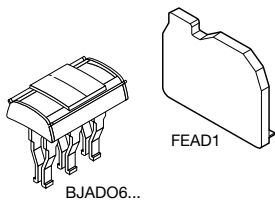

BJADO6...

FEAD1

DH 4/8.ADO - 2.5 mm² miniblocks - 8 mm .315" spacing

Characteristics		IEC NFC DIN		UL/CSA
Wire size mm ² / AWG	Screw	Solid	0.2 - 4 mm ²	22-10 AWG
		Stranded	0.22 - 4 mm ²	
	ADO	Solid	1 - 2.5 mm ²	16-14 AWG
		Stranded	1 - 2.5 mm ²	
Voltage	V	800 V	600 V	
Pulse	kV	8 kV		
Current	A	24 A	25 A	
Rated wire size	mm ² / AWG	2.5 mm ²	14 AWG	
Wire stripping length	mm / inches	9.5 mm / .374"		
Recommended torque (screw)	Nm / lb.in	0.5-0.8 Nm / 4.4-7.1 lb.in		

2 wires of the same gauge and nature per ADO connection

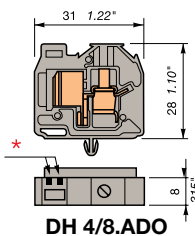

DH 4/8.ADO

Selection

Description	Type	Order P/N	Packaging	
Base mount miniblocks	grey <input type="checkbox"/>	DH 4/8.ADO	0299 525.22	100
with snap-in mounting	blue <input type="checkbox"/>	DH 4/8.N.ADO	0299 527.24	100
foot	orange <input type="checkbox"/>	DH 4/8.ADO	0299 526.23	100

Accessories

End section V0	grey <input type="checkbox"/>	FEAD1	2.5 mm	0199 421.16	20
	orange <input type="checkbox"/>	FEAD1	2.5 mm	0199 422.17	20
Comb-type jumper bar	2 poles	PC8	50 A	0116 538.17	10
	3 poles	PC8	50 A	0116 539.10	10
	4 poles	PC8	50 A	0116 540.25	10
	10 poles	PC8	50 A	0163 313.24	10

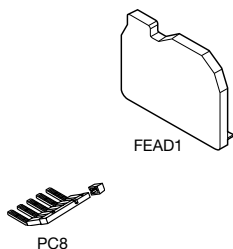

FEAD1

PC8



Miniblocks

Base mount with flanges

ADO - Screw clamp

ADO Screw clamp

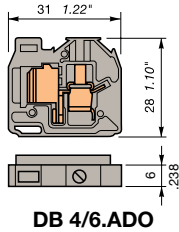

DB 4/6.ADO

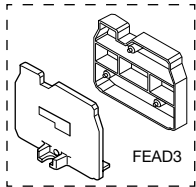

FEAD3

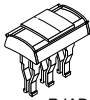

BJADO6...

DB 4/6.ADO - 1.5 mm² miniblocks - 6 mm .236" spacing

Characteristics

Wire size mm ² / AWG	Screw	IEC NFC DIN		UL/CSA
		Solid	Stranded	
	ADO	Solid	0.28 - 1.5 mm ²	22-16 AWG
		Stranded	0.34 - 1.5 mm ²	
Voltage	V	800 V	600 V	
Pulse	kV	8 kV		
Current	A	17.5 A	20 A	
Rated wire size	mm ² / AWG	1.5 mm ²	16 AWG	
Wire stripping length	mm / inches	9.5 mm / .374"		
Recommended torque (screw)	Nm / lb.in	0.5-0.8 Nm / 4.4-7.1 lb.in		

2 wires of the same gauge and nature per ADO connection

Selection

Description	Type	Order P/N	Packaging	
Base mount miniblocks with flanges	grey <input type="checkbox"/>	DB 4/6.ADO	0299 505.07	100
	blue <input type="checkbox"/>	DB 4/6.N.ADO	0299 507.01	100
	orange <input type="checkbox"/>	DB 4/6.ADO	0299 506.00	100

Accessories

End section flanges (right + left)	grey V0 <input type="checkbox"/>	FEAD3	0199 437.16	20	
	orange V0 <input type="checkbox"/>	FEAD3	0199 438.27	20	
Screwless jumper bar IP 20	orange <input type="checkbox"/>	BJADO6.2	17.5 A	0205 974.06	20
		BJADO6.3	17.5 A	0205 975.07	20
		BJADO6.4	17.5 A	0205 976.00	20
		BJADO6.5	17.5 A	0205 977.01	20
		BJADO6.10	17.5 A	0205 982.27	10

DB 4/8.ADO - 2.5 mm² miniblocks - 8 mm .315" spacing

Characteristics

Wire size mm ² / AWG	Screw	IEC NFC DIN		UL/CSA
		Solid	Stranded	
	ADO	Solid	1 - 2.5 mm ²	16-14 AWG
		Stranded	1 - 2.5 mm ²	
Voltage	V	800 V	600 V	
Pulse	kV	8 kV		
Current	A	24 A	25 A	
Rated wire size	mm ² / AWG	2.5 mm ²	14 AWG	
Wire stripping length	mm / inches	9.5 mm / .374"		
Recommended torque (screw)	Nm / lb.in	0.5-0.8 Nm / 4.4-7.1 lb.in		

2 wires of the same gauge and nature per ADO connection

Selection

Description	Type	Order P/N	Packaging	
Base mount miniblocks with flanges	grey <input type="checkbox"/>	DB 4/8.ADO	0299 509.13	100
	blue <input type="checkbox"/>	DB 4/8.N.ADO	0299 511.24	100
	orange <input type="checkbox"/>	DB 4/8.ADO	0299 510.07	100

Accessories

End section flanges (right + left)	grey V0 <input type="checkbox"/>	FEAD3	0199 437.16	20	
	orange V0 <input type="checkbox"/>	FEAD3	0199 438.27	20	
Comb-type jumper bar	2 poles	PC8	50 A	0116 538.17	10
	3 poles	PC8	50 A	0116 539.10	10
	4 poles	PC8	50 A	0116 540.25	10
	10 poles	PC8	50 A	0163 313.24	10

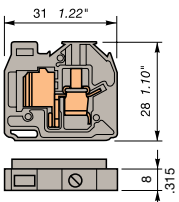

DB 4/8.ADO

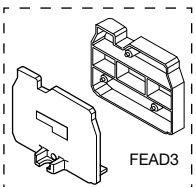

FEAD3

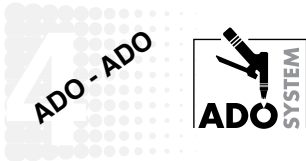

Feed through and ground terminal blocks

Insulation displacement

ADO - ADO, \mathcal{U} DIN 3

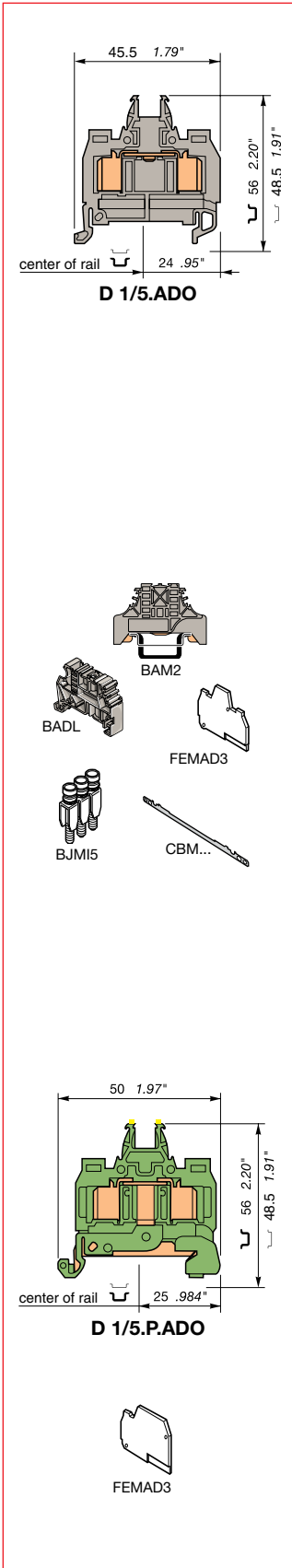

D 1/5.ADO - 1 mm² blocks - 5 mm .198" spacing

Characteristics

Wire size mm ² / AWG	Screw	IEC NFC DIN		UL	CSA
		Solid	Stranded		
	ADO	Solid	0.2 - 1	24-18 AWG	24-18 AWG
		Stranded	0.22 - 1		
Voltage	V	1000	600	600	
Current	A	13.5	7	7	
Short circuit current (D 1/5.PI.ADO)	A / s	120 A/1s			
Rated wire size	mm ² / AWG	1 mm ²	18 AWG	18 AWG	

2 wires of the same gauge and nature per ADO connection

Selection

Description	Type	Order P/N	Packaging
Standard block grey	<input type="checkbox"/> D 1/5.ADO	0199 563.24	50
Standard block orange	<input type="checkbox"/> D 1/5.ADO	0199 564.25	50
Standard block blue	<input type="checkbox"/> D 1/5.N.ADO	0199 565.26	50
Standard block black	<input type="checkbox"/> D 1/5.ADO	0199 566.27	50
Standard block red	<input type="checkbox"/> D 1/5.ADO	0199 567.20	50
Standard block yellow	<input type="checkbox"/> D 1/5.ADO	0199 569.02	50
Standard block ivory	<input type="checkbox"/> D 1/5.ADO	0199 568.01	50
Standard block green	<input type="checkbox"/> D 1/5.ADO	0199 570.07	50
Ground block yellow body/ green marking (without rail contact)	<input type="checkbox"/> D 1/5.PI.ADO	0399 184.21	50

Accessories

End stop	BADL	9 mm	0399 903.02	(screwless)	50
	BAM2	9.9 mm	0399 967.01	(with screw)	50
End section	grey <input type="checkbox"/>	FEMAD3	3 mm	0199 341.05	20
	yellow <input type="checkbox"/>	FEMAD3	3 mm	0199 343.07	20
Assembled jumper bar (with IP20 protection)	2 poles	BJMI5	24 A	0176 278.16	10
	3 poles	BJMI5	24 A	0176 279.17	10
	4 poles	BJMI5	24 A	0176 280.05	10
	5 poles	BJMI5	24 A	0176 281.22	10
	10 poles	BJMI5	24 A	0176 282.23	10
Shield connector	CBM5	0.5 mm	0178 745.14	50	
	CBM8	0.8 mm	0178 746.15	50	

D 1/5.P.ADO - 1 mm² ground block with rail contact - 5 mm .198" spacing

Characteristics

Wire size mm ² / AWG	Screw	IEC NFC DIN		UL	CSA
		Solid	Stranded		
	ADO	Solid	0.2 - 1	24-18AWG	24-18AWG
		Stranded	0.22 - 1		
Short circuit current	A / s	120 A/1s			
Rated wire size	mm ² / AWG				

2 wires of the same gauge and nature per ADO connection

Selection

Description	Type	Order P/N	Packaging
Ground block green body/yellow marking	<input type="checkbox"/> D 1/5.P.ADO	0399 031.22	50

Accessories

End section	yellow <input type="checkbox"/>	FEMAD3	3 mm	0199 343.07	20
	grey <input type="checkbox"/>	FEMAD3	3 mm	0199 341.05	20



Feed through and ground terminal blocks

Insulation displacement

ADO - ADO, U DIN 3

ADO - ADO

D 1,5/6... .ADO - 1.5 mm² blocks - 6 mm .238" spacing

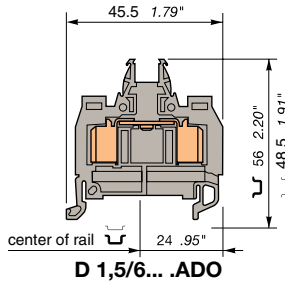

		IEC	UL	CSA
		NFC		
		DIN		
Wire size mm ² / AWG	Screw	Solid	—	—
		Stranded	—	—
	ADO	Solid	0.34 - 1.5	22-16 AWG
		Stranded	0.34 - 1.5	22-16 AWG
Voltage	V	1000	600	600
Current	A	17.5	18	18
Short circuit current (D 1,5/6.PI.ADO)	A / s		180 A/1s	
Rated wire size	mm ² / AWG	1.5 mm ²	16 AWG	16 AWG

2 wires of the same gauge and nature per ADO connection

Selection

Description	Type	Order P/N	Packaging
Standard block grey	<input type="checkbox"/> D 1,5/6.ADO	0199 051.26	50
Standard block orange	<input type="checkbox"/> D 1,5/6.ADO	0199 052.27	50
Standard block blue	<input type="checkbox"/> D 1,5/6.N.ADO	0199 053.20	50
Standard block black	<input type="checkbox"/> D 1,5/6.ADO	0199 083.17	50
Standard block red	<input type="checkbox"/> D 1,5/6.ADO	0199 081.15	50
Standard block yellow	<input type="checkbox"/> D 1,5/6.ADO	0199 080.20	50
Standard block ivory	<input type="checkbox"/> D 1,5/6.ADO	0199 082.16	50
Standard block green	<input type="checkbox"/> D 1,5/6.ADO	0199 056.23	50
Ground block yellow body/ green marking (without rail contact)	<input type="checkbox"/> D 1,5/6.PI.ADO	0199 054.21	50

Accessories

End stop	light grey	BADL 9 mm	0399 903.02	(screwless)	50
		BAM2 9.9 mm	0399 967.01	(with screw)	50
End section	grey <input type="checkbox"/>	FEMAD3 3 mm	0199 341.05		20
	yellow <input type="checkbox"/>	FEMAD3 3 mm	0199 343.07		20
Assembled jumper bar (with IP20 protection)	2 poles	BJMI6 32 A	0176 663.00		10
	3 poles	BJMI6 32 A	0176 664.01		10
	4 poles	BJMI6 32 A	0176 665.02		10
	5 poles	BJMI6 32 A	0176 666.03		10
	10 poles	BJMI6 32 A	0176 667.04		10
Shield connector		CBM5 0.5 mm	0178 745.14		50
		CBM8 0.8 mm	0178 746.15		50

4

D 1,5/6.P.ADO - 1.5 mm² ground block with rail contact - 6 mm .198" spacing

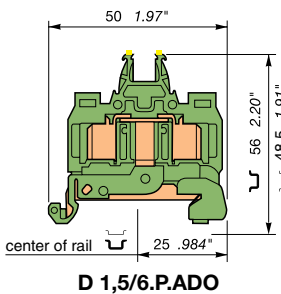

		IEC	UL	CSA
		NFC		
		DIN		
Wire size mm ² / AWG	Screw	Solid	—	—
		Stranded	—	—
	ADO	Solid	0.34 - 1.5	22-16AWG
		Stranded	0.34 - 1.5	22-16AWG
Short circuit current	A / s	180 A/1s		
Rated wire size	mm ² / AWG	1.5 mm ²	16 AWG	16 AWG

2 wires of the same gauge and nature per ADO connection

Selection

Description	Type	Order P/N	Packaging
Ground block green body/yellow marking	<input type="checkbox"/> D 1,5/6.P.ADO	0199 098.26	50

Accessories

End section	yellow <input type="checkbox"/>	FEMAD3 3 mm	0199 343.07	20
	grey <input type="checkbox"/>	FEMAD3 3 mm	0199 341.05	20

Feed through and ground terminal blocks

Insulation displacement

ADO - ADO, U DIN 3

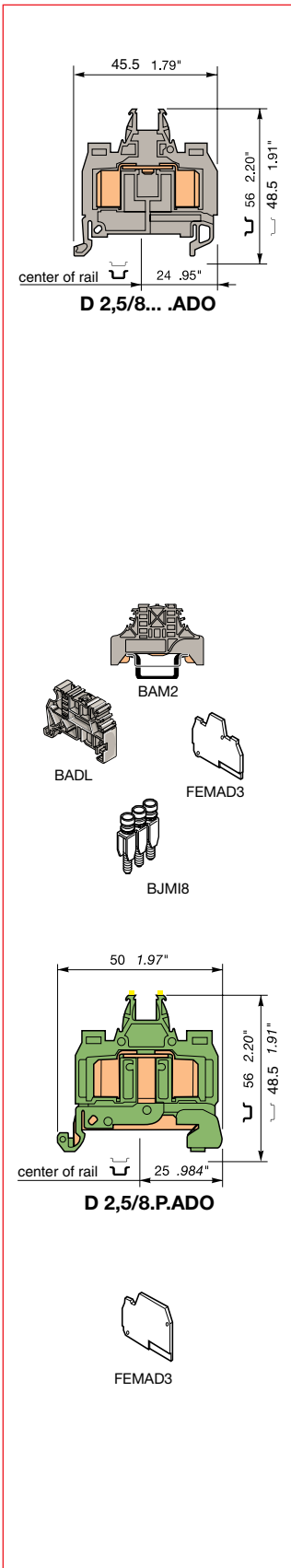

D 2,5/8... ADO - 2.5 mm² blocks - 8 mm .315" spacing

Characteristics

Wire size mm ² / AWG	Screw	IEC NFC DIN			UL	CSA
		Solid	Stranded	—		
	ADO	Solid	1 - 2.5	16-14 AWG	16-14 AWG	2 wires of the same gauge and nature per ADO connection
		Stranded	1 - 2.5			
Voltage		V	1000	600	600	
Current		A	24	25	25	
Short circuit current (D 2,5/8.PI.ADO)		A / s		300 A/1s		
Rated wire size		mm ² / AWG	2.5 mm ²	16 AWG	16 AWG	

Selection

Description	Type	Order P/N	Packaging
Standard block grey	<input type="checkbox"/> D 2,5/8.ADO	0199 059.06	50
Standard block orange	<input type="checkbox"/> D 2,5/8.ADO	0199 060.03	50
Standard block blue	<input type="checkbox"/> D 2,5/8.N.ADO	0199 061.20	50
Standard block black	<input type="checkbox"/> D 2,5/8.ADO	0199 089.25	50
Standard block red	<input type="checkbox"/> D 2,5/8.ADO	0199 087.13	50
Standard block yellow	<input type="checkbox"/> D 2,5/8.ADO	0199 092.10	50
Standard block ivory	<input type="checkbox"/> D 2,5/8.ADO	0199 088.24	50
Standard block green	<input type="checkbox"/> D 2,5/8.ADO	0199 148.04	50
Ground block yellow body/ green marking (without rail contact)	<input type="checkbox"/> D 2,5/8.PI.ADO	0199 148.04	50
		0199 062.21	50

Accessories

End stop	light grey	BADL	9 mm	0399 903.02	(screwless)	50
		BAM2	9.9 mm	0399 967.01	(with screw)	50
End section	grey	<input type="checkbox"/> FEMAD3	3 mm	0199 341.05		20
End section	yellow	<input type="checkbox"/> FEMAD3	3 mm	0199 343.07		20
Assembled jumper bar (with IP20 protection)	2 poles	BJMI8	41 A	0176 669.16		10
	3 poles	BJMI8	41 A	0176 670.13		10
	4 poles	BJMI8	41 A	0176 671.00		10
	5 poles	BJMI8	41 A	0176 672.01		10
	10 poles	BJMI8	41 A	0176 673.02		10

D 2,5/8.P.ADO - 2.5 mm² ground block with rail contact - 8 mm .315" spacing

Characteristics

Wire size mm ² / AWG	Screw	IEC NFC DIN			UL	CSA
		Solid	Stranded	—		
	ADO	Solid	1 - 2.5	16-14AWG	16-14AWG	2 wires of the same gauge and nature per ADO connection
		Stranded	1 - 2.5			
Short circuit current		A / s	300 A/1s	—	—	
Rated wire size		mm ² / AWG	2.5 mm ²	14 AWG	14 AWG	

Selection

Description	Type	Order P/N	Packaging
Ground block green body/yellow marking	<input type="checkbox"/> D 2,5/8.P.ADO	0199 091.17	50

Accessories

End section	yellow	<input type="checkbox"/> FEMAD3	3 mm	0199 343.07	20
	grey	<input type="checkbox"/> FEMAD3	3 mm	0199 341.05	20

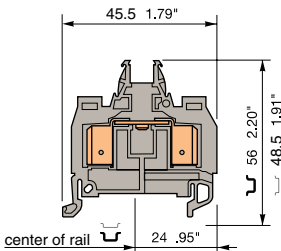

D 4/8.ADO

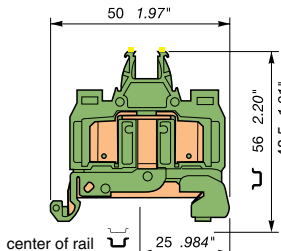
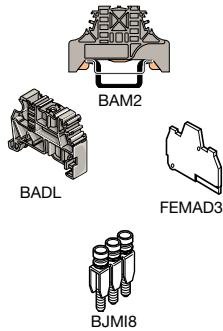

D 4/8.P.ADO

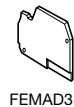

D 4/8.ADO - 4 mm² blocks - 8 mm .315" spacing

Characteristics

Wire size mm ² / AWG	Screw	IEC		UL	CSA
		NFC	DIN		
	ADO	Solid	4	14-12 AWG	14-12 AWG
		Stranded	4	12 AWG	12 AWG
Voltage		1000		600	600
Current	A	32		25	25
Short circuit current (D 4/8.PI.ADO)	A / s	480 A/1s			
Rated wire size	mm ² / AWG	4 mm ²		12 AWG	12 AWG

Only one wire per ADO connection

Selection

Description	Type	Order P/N	Packaging
Standard block grey	D 4/8.ADO	0399 244.14	50
Standard block blue	D 4/8.N.ADO	0399 318.16	50
Standard block orange	D 4/8.ADO	0399 801.04	50
Ground block yellow body/ green marking (without rail contact)	D 4/8.PI.ADO	0399 272.10	50

Accessories

End stop	light grey	BADL	9 mm	0399 903.02	(screwless)	50
		BAM2	9.9 mm	0399 967.01	(with screw)	50
End section	grey	FEMAD3	3 mm	0199 341.05		20
	yellow	FEMAD3	3 mm	0199 343.07		20
Assembled jumper bar (with IP20 protection)	2 poles	BJMI8	41 A	0176 669.16		10
	3 poles	BJMI8	41 A	0176 670.13		10
	4 poles	BJMI8	41 A	0176 671.00		10
	5 poles	BJMI8	41 A	0176 672.01		10
	10 poles	BJMI8	41 A	0176 673.02		10

D 4/8.P.ADO - 4 mm² ground block with rail contact - 8 mm .315" spacing

Characteristics

Wire size mm ² / AWG	Screw	IEC		UL	CSA
		NFC	DIN		
	ADO	Solid	4	14-12 AWG	14-12 AWG
		Stranded	4	12 AWG	12 AWG
Short circuit current	A / s	480 A/1s			
Rated wire size	mm ² / AWG	4 mm ²		12 AWG	12 AWG

Only one wire per ADO connection

Selection

Description	Type	Order P/N	Packaging
Ground block green body/yellow marking	D 4/8.P.ADO	0399 250.26	50

Accessories

End section	yellow	FEMAD3	3 mm	0199 343.07	20
	grey	FEMAD3	3 mm	0199 341.05	20

Feed through terminal blocks

Double deck insulation displacement

ADO - ADO, \surd DIN 3

D 1,5/6.D2.ADO - 1.5 mm² blocks - 6 mm .238" spacing

Characteristics

			IEC NFC DIN	UL	CSA
Wire size mm ² / AWG	Screw	Solid	—	—	—
		Stranded	—	—	—
	ADO	Solid	0.28 - 1.5	22-16 AWG	22-16 AWG
		Stranded	0.34 - 1.5		
Voltage	V	800	300	300	
Current	A	17.5	18	18	
Rated wire size	mm ² / AWG	1.5 mm ²	16 AWG	16 AWG	

2 wires of the same gauge and nature per ADO connection

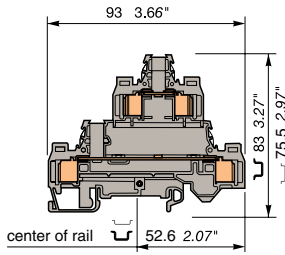

D 1,5/6.D2.ADO

Selection

Description	Type	Order P/N	Packaging
Standard block grey	<input type="checkbox"/> D 1.5/6.D2.ADO	0199 480.26	50
Standard block orange	<input type="checkbox"/> D 1.5/6.D2.ADO	0199 481.13	50
Standard block blue	<input type="checkbox"/> D 1.5/6.D2.N.ADO	0199 482.14	50

Accessories

End stop		BADH	12 mm	0116 900.27	50
		BAMH	9.1 mm	0114 836.00	50
End section	grey <input type="checkbox"/>	FED2AD2	5 mm	0199 476.25	20
Assembled jumper bar (with IP20 protection)	2 poles	BJMI6	32 A	0176 663.00	10
	3 poles	BJMI6	32 A	0176 664.01	10
	4 poles	BJMI6	32 A	0176 665.02	10
	5 poles	BJMI6	32 A	0176 666.03	10
	10 poles	BJMI6	32 A	0176 667.04	10
Shield connector		CBD2S		0178 408.14	50

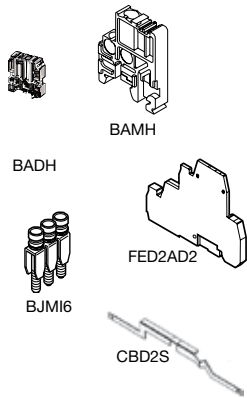

D 1/5.C...ADO - 1 mm² blocks - 5 mm .197" spacing

Characteristics

Wire size mm ² / AWG	Solid Stranded	IEC	UL	CSA
		NFC DIN		
		0.2 - 1	—	—
		0.22 - 1	—	—
Voltage	V	250	—	—
Current	A	13.5	—	—
Rated wire size	mm ² / AWG	1 mm ²	—	—

Only one wire per ADO connection

Selection

Description	Type	Order P/N	Packaging
Standard block grey	D 1/5.C2.ADO	0399 686.00	50
Standard block grey	D 1/5.C3.ADO	0399 689.13	50
Standard block grey	D 1/5.C4.ADO	0399 692.06	50

Accessories

End stop	light grey	BADL 9 mm	0399 903.02	(screwless)	50
		BAM2 9.9 mm	0399 967.01	(with screw)	50
End section kit	grey	FED5.C2.ADO	0399 677.16		20
	grey	FED5.C3.ADO	0399 678.27		20
	grey	FED5.C4.ADO	0399 679.20		20
Comb type jumper bar	blue	PC52.10	10 poles	0399 684.06	10
	red	PC52.10	10 poles	0399 683.05	10
	green/yellow	PC52.10	10 poles	0399 685.07	10
	blue	PC52.66	66 poles	0399 707.15	10
	red	PC52.66	66 poles	0399 708.26	10
	green/yellow	PC52.66	66 poles	0399 709.27	10

* End section kit includes :

- 1 right end section
- 1 left end section
- 1 marker-holder

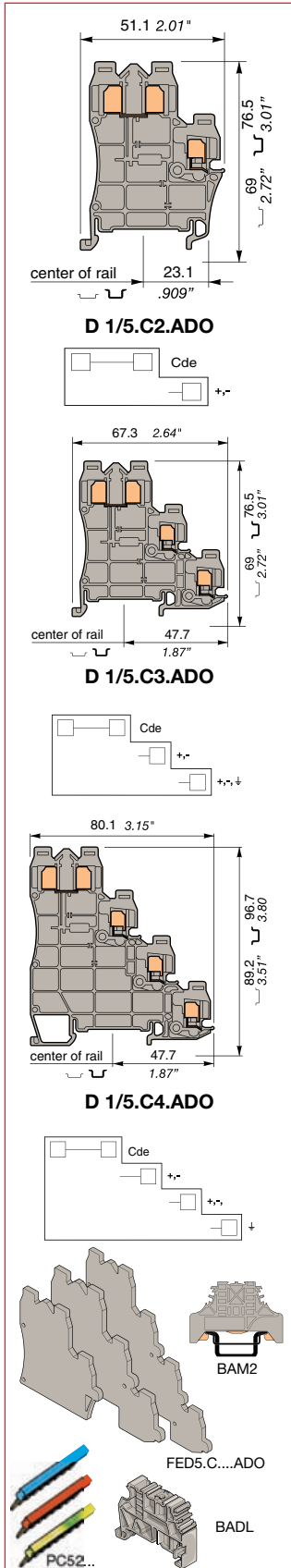

Heavy duty switch terminal blocks with blade

Insulation displacement

ADO - ADO, DIN 3

D 1/5.SNT2.ADO - 1 mm² blocks - 5 mm .200" spacing

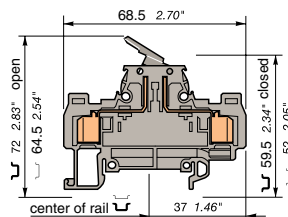

D 1/5.SNT2.ADO

Characteristics

Wire size mm ² / AWG	Screw	IEC NFC DIN		UL	CSA
		Solid	Stranded		
	ADO	Solid	0.2 - 1	24-18 AWG	24-18 AWG
		Stranded	0.22 - 1		
Voltage		V	320	300	300
Current		A	10		
Rated wire size		mm ² / AWG	1 mm ²	18 AWG	18 AWG

2 wires of the same gauge and nature per ADO connection

Selection

Description	Type	Order P/N	Packaging
Standard block grey	<input type="checkbox"/> D 1/5.SNT2.ADO	0399 231.07	50
Standard block orange	<input checked="" type="checkbox"/> D 1/5.SNT2.ADO	0399 232.00	50

D 1,5/6.SNT2.ADO - 1.5 mm² blocks - 6 mm .238" spacing

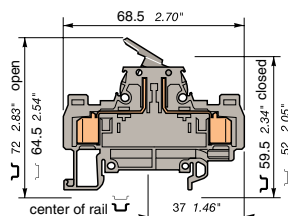

D 1,5/6.SNT2.ADO

Characteristics

Wire size mm ² / AWG	Screw	IEC NFC DIN		UL	CSA
		Solid	Stranded		
	ADO	Solid	0.34 - 1.5	22-16 AWG	22-16 AWG
		Stranded	0.34 - 1.5		
Voltage		V	500	600	600
Current		A	10	8	10
Rated wire size		mm ² / AWG	1.5 mm ²	16 AWG	16 AWG

2 wires of the same gauge and nature per ADO connection

Selection

Description	Type	Order P/N	Packaging
Standard block grey	<input type="checkbox"/> D 1,5/6.SNT2.ADO	0199 144.20	50
Standard block orange	<input checked="" type="checkbox"/> D 1,5/6.SNT2.ADO	0199 145.21	50
Standard block blue	<input type="checkbox"/> D 1,5/6.SNT2.ADO	0199 591.11	50

D 2,5/8.SNT2.ADO - 2.5 mm² blocks - 8 mm .315" spacing

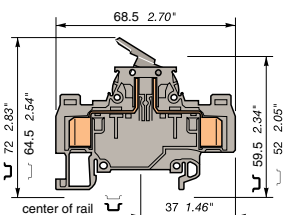

D 2,5/8.SNT2.ADO

Characteristics

Wire size mm ² / AWG	Screw	IEC NFC DIN		UL	CSA
		Solid	Stranded		
	ADO	Solid	1 - 2.5	16-14 AWG	16-14 AWG
		Stranded	1 - 2.5		
Voltage		V	500	600	60000
Current		A	15	15	15
Rated wire size		mm ² / AWG	2.5 mm ²	16 AWG	16 AWG

2 wires of the same gauge and nature per ADO connection

Selection

Description	Type	Order P/N	Packaging
Standard block grey	<input type="checkbox"/> D 2,5/8.SNT2.ADO	0199 231.27	50
Standard block orange	<input checked="" type="checkbox"/> D 2,5/8.SNT2.ADO	0199 232.20	50

Accessories

End stop	light grey	BADL	9 mm	0399 903.02	(screwless)	50
		BAM2	9.9 mm	0399 967.01	(with screw)	50
End section	grey	FEDAD5	2 mm	0199 354.02		20
	orange	FEDAD5	2 mm	0199 355.03		20
Shielding connector		CDB2	0.8 mm ^①	0179 635.07		50
Screwless jumper bar orange IP20	2 poles	BJADO5.2	13.5 A ^②	0205 955.03		20
	3 poles	BJADO5.3	13.5 A ^②	0205 956.04		20
	4 poles	BJADO5.4	13.5 A ^②	0205 957.05		20
	5 poles	BJADO5.5	13.5 A ^②	0205 958.16		20
	10 poles	BJADO5.10	13.5 A ^②	0205 963.03		10
	Screwless jumper bar orange IP20	2 poles	BJADO6.2	17.5 A ^③	0205 974.06	
3 poles		BJADO6.3	17.5 A ^③	0205 975.07		20
4 poles		BJADO6.4	17.5 A ^③	0205 976.00		20
5 poles		BJADO6.5	17.5 A ^③	0205 977.01		20
10 poles		BJADO6.10	17.5 A ^③	0205 982.27		10

^① Except for D 2,5/8.SNT2.ADO

^② Only for D 1/5.SNT2.ADO

^③ Only for D 1,5/6.SNT2.ADO

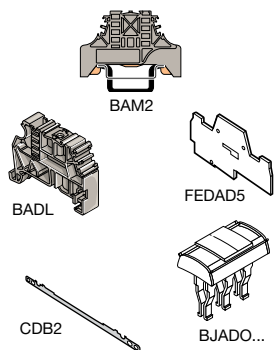



Fuse holder terminal blocks

5x20 mm .197x.787 in. and 5x25 mm .197x.984 in.

ADO - ADO, DIN 3

ADO - ADO

D 1,5/8.SFT.ADO - 1.5 mm² blocks - 8 mm .315" spacing

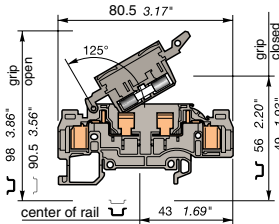

D 1,5/8.SFT.ADO

Characteristics

			IEC NFC DIN	UL	CSA
Wire size mm ² / AWG	Screw	Solid	—	—	—
		Stranded	—	—	—
	ADO	Solid	0.34 - 1.5	22-16 AWG	22-16 AWG
		Stranded	0.34 - 1.5		
Voltage	V	630 ①	600 ①	600 ①	
Current	A	6.3	8	10	
Rated wire size	mm ² / AWG	1.5 mm ²	16 AWG	16 AWG	

2 wires of the same gauge and nature per ADO connection

Selection

Description	Type	Order P/N	Packaging
Standard block grey	D 1,5/8.SFT.ADO	0199 208.11	50
Standard block orange	D 1,5/8.SFT.ADO	0199 209.12	50

With DIA. 2 or 2.3 mm screw test socket for test

D 1,5/8.SF...T.ADO - 1.5 mm² blocks - 8 mm .315" spacing

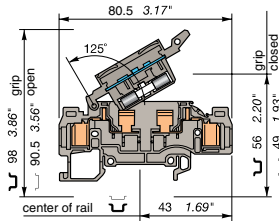

D 1,5/8.SF...T.ADO

Characteristics

			IEC NFC DIN	UL	CSA
Wire size mm ² / AWG	Screw	Solid	—	—	—
		Stranded	—	—	—
	ADO	Solid	0.34 - 1.5	22-16 AWG	22-16 AWG
		Stranded	0.34 - 1.5		
Voltage	V	500 ①	600 ①	600 ①	
Current	A	6.3	8	10	
Rated wire size	mm ² / AWG	1.5 mm ²	16 AWG	16 AWG	

2 wires of the same gauge and nature per ADO connection

Selection

Description	Type	Order P/N	Packaging
Standard block grey ②	D 1,5/8.SFLT.ADO	0199 211.23	50
Standard block grey ③	D 1,5/8.SFDT.ADO	0199 212.24	50

With DIA. 2 or 2.3 mm screw test socket for test

D 1,5/8.SNNT.ADO - 1.5 mm² blocks - 8 mm .315" spacing

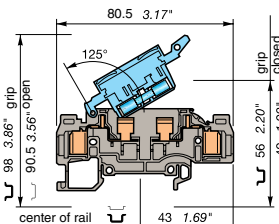

D 1,5/8.SNNT.ADO

Characteristics

			IEC NFC DIN	UL	CSA
Wire size mm ² / AWG	Screw	Solid	—	—	—
		Stranded	—	—	—
	ADO	Solid	0.34 - 1.5	22-16 AWG	22-16 AWG
		Stranded	0.34 - 1.5		
Voltage	V	630	600	600	
Current	A	10	8	10	
Rated wire size	mm ² / AWG	1.5 mm ²	16 AWG	16 AWG	

2 wires of the same gauge and nature per ADO connection

Selection

Description	Type	Order P/N	Packaging
Standard block grey body/ blue grip	D 1,5/8.SNNT.ADO	0199 210.06	50

With DIA. 2 or 2.3 mm test on two sides.

Accessories

Description	Type	Order P/N	Accessories	Packaging
End stop	BADL 9 mm	0399 903.02	(screwless)	50
	light grey BAM2 9.9 mm	0399 967.01	(with screw)	50
End section	grey	FEDAD7 1.5 mm		20

① Terminal block insulation voltage. Working voltage according to fuse.

② Blow-fuse indicator by 110 V - 230 V neon lamp (leakage current with neon lamp < 0,5 mA (110 V) - < 0,7 mA (230 V)).

③ Blow-fuse indicator by LED 24 V (+24V labeled) (leakage current with LED 24 V or 48 V < 4,5 mA).

Fuse holder terminal blocks

5x20 mm .197x.787 in. and 5x25 mm .197x.984 in.

ADO - ADO,  DIN 3

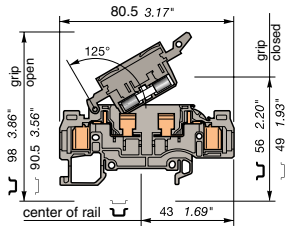

D 2,5/8.SFT.ADO2

D 2,5/8.SFT.ADO2 - 2.5 mm² blocks - 8 mm .315" spacing

Characteristics

Wire size mm ² / AWG	Screw	IEC NFC DIN		UL	CSA
		Solid	—	—	—
	ADO	Solid	1 - 2.5	16-14 AWG	16-14 AWG
		Stranded	1 - 2.5		
Voltage	V	630 ①	600 ①	600 ①	
Current	A	6.3	10	10	
Rated wire size	mm ² / AWG	2.5 mm ²	14 AWG	14 AWG	

2 wires of the same gauge and nature per ADO connection

Selection

Description	Type	Order P/N	Packaging
Standard block grey <input type="checkbox"/>	D 2,5/8.SFT.ADO2	0199 184.11	50
Standard block orange <input type="checkbox"/>	D 2,5/8.SFT.ADO2	0199 185.12	50

For test sockets DIA. 2 or DIA. 2.3 mm.

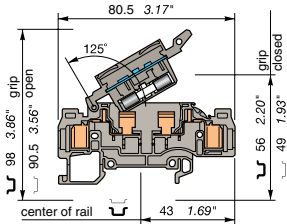

D 2,5/8.SF...T.ADO2

D 2,5/8.SF...T.ADO2 - 2.5 mm² blocks - 8 mm .315" spacing

Characteristics

Wire size mm ² / AWG	Screw	IEC NFC DIN		UL	CSA
		Solid	—	—	—
	ADO	Solid	1 - 2.5	16-14 AWG	16-14 AWG
		Stranded	1 - 2.5		
Voltage	V	500 ①	600 ①	600 ①	
Current	A	6.3	10	10	
Rated wire size	mm ² / AWG	2.5 mm ²	14 AWG	14 AWG	

2 wires of the same gauge and nature per ADO connection

Selection

Description	Type	Order P/N	Packaging
Standard block grey ② <input type="checkbox"/>	D 2,5/8.SFLT.ADO2	0199 187.14	50
Standard block orange ③ <input type="checkbox"/>	D 2,5/8.SFDT.ADO2	0199 188.25	50

With DIA. 2 or 2.3 mm screw test socket for test

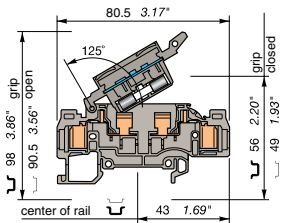

D 2,5/8.SNNT.ADO2

D 2,5/8.SNNT.ADO2 - 2.5 mm² blocks - 8 mm .315" spacing

Characteristics

Wire size mm ² / AWG	Screw	IEC NFC DIN		UL	CSA
		Solid	—	—	—
	ADO	Solid	1 - 2.5	16-14 AWG	16-14 AWG
		Stranded	1 - 2.5		
Voltage	V	630	600	250	
Current	A	10	10	10	
Rated wire size	mm ² / AWG	2.5 mm ²	14 AWG	14 AWG	

2 wires of the same gauge and nature per ADO connection

Selection

Description	Type	Order P/N	Packaging
Standard block grey body/ blue grip <input type="checkbox"/>	D 2,5/8.SNNT.ADO2	0199 186.13	50

Accessories

End stop	light grey	BADL	9 mm	0399 903.02	(screwless)	50
		BAM2	9.9 mm	0399 967.01	(with screw)	50
End section	grey <input type="checkbox"/>	FEDAD7	1.5 mm	0199 382.27		20

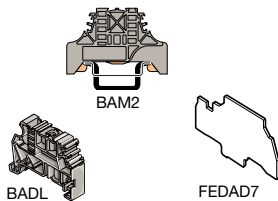

① Terminal block insulating voltage. Working voltage according to fuse.

② Blown-fuse indicator by 110 V - 230 V neon lamp (leakage current with neon lamp < 0,5 mA (110 V) - < 0,7 mA (230 V)).

③ Blown-fuse indicator by LED 24 V (+24V labeled) (leakage current with LED 24 V or 48 V < 4,5 mA).

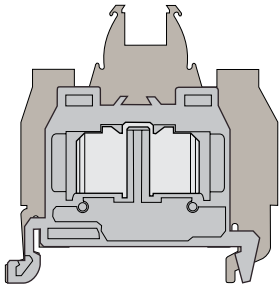

A reduced size range

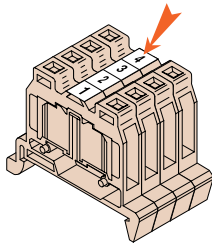

A very legible marking

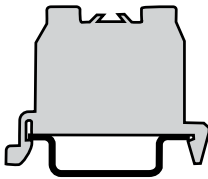

DS=DIN3
Mounting on DIN 3 rail

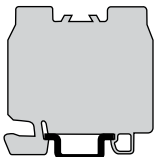

DR=DIN2
Mounting on DIN 2 rail

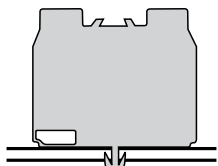

DH = snap-in

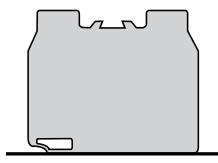

DB = flanges
Panel mounting

Miniblock mounting and accessories

Rail mounting DIN 2 and DIN 3 DIN 2 : DR...ADO - DIN 3 : DS...ADO

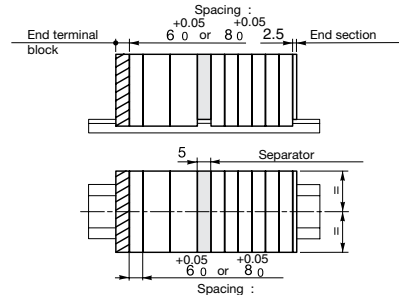

At the end of the terminal block assembly :

- **End section :** (same accessory for any type of terminal block assembly)

FEAD1 : V/ADO
FEAD2 : ADO/ADO

End section to be mounted directly on the open part of the terminal block.

- **End terminal block :**

DRE... ADO (DIN2)
DSE... ADO (DIN3)

This terminal block has to be mounted at the end of the terminal block assembly : it reduces its size, because it suppresses the insulation rib (- 4 mm).

Nota : This terminal block cannot be accidentally located anywhere else into the terminal block assembly (without locking holes).

In the terminal block assembly :

- **Separator :** (same accessory for any type of terminal terminal block assembly)

FEAD5 : V/ADO
FEAD6 : ADO/ADO

Accessory which snaps on the terminal blocks, separates and makes visible the different parts of the terminal block assembly.

Base mounting

Snap on : DH...ADO

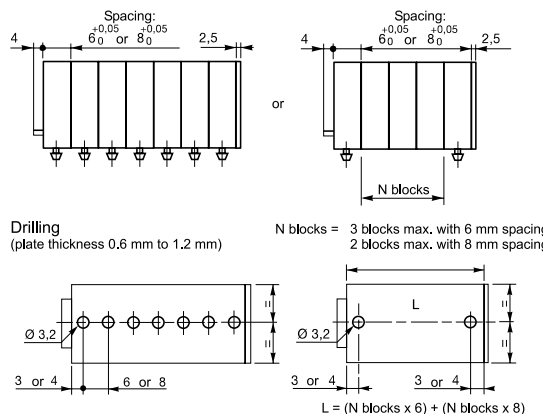

With flanges : DB...ADO

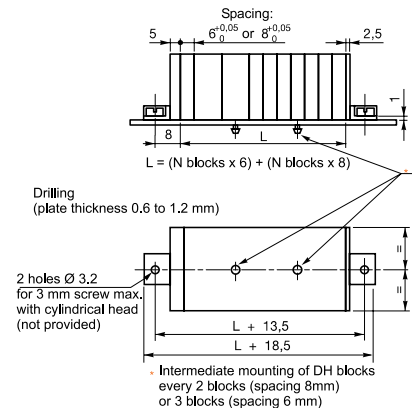

Miniblocks

Feed through

ADO - ADO DIN 3

DS 1,5/6.ADO - 1.5 mm² miniblocks - 6 mm .236" spacing

Characteristics

Wire size		IEC		UL/CSA
mm ² / AWG		NFC DIN		
ADO	Solid	0.28 - 1.5 mm ²		22-16 AWG
	Stranded	0.34 - 1.5 mm ²		
Voltage		V	1000 V	600 V
Pulse		kV	—	—
Current		A	17.5 A	20 A
Rated wire size		mm ² / AWG	1.5 mm ²	16 AWG

Selection

Description	Type	Order P/N	Packaging	
DIN 3 miniblocks	grey <input type="checkbox"/>	DS 1,5/6.ADO	0299 497.27	100
	blue <input type="checkbox"/>	DS 1,5/6.N.ADO	0299 499.01	100
	orange <input type="checkbox"/>	DS 1,5/6.ADO	0299 498.00	100
	grey <input type="checkbox"/>	DSE 1,5/6.ADO	0299 558.13	20

Accessories

End stop V0		BADL	9 mm	0399 903.02	(screwless)	50
	light grey	BAM2	9.9 mm	0399 967.01	(with screw)	50
End section	grey V0 <input type="checkbox"/>	FEAD2	2.5 mm	0199 423.10		20
	orange V0 <input type="checkbox"/>	FEAD2	2.5 mm	0199 424.11		20
Screwless jumper bar IP 20	orange <input type="checkbox"/>	BJADO6.2	17.5 A	0205 974.06		20
		BJADO6.3	17.5 A	0205 975.07		20
		BJADO6.4	17.5 A	0205 976.00		20
		BJADO6.5	17.5 A	0205 977.01		20
		BJADO6.10	17.5 A	0205 982.27		10

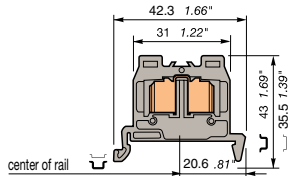

DS (with rib)
DSE (without rib
only for T.B.
assembly extremity)

DS 1,5/6.ADO

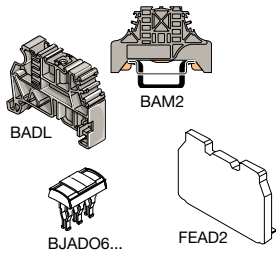

4

DS 2,5/8.ADO - 2.5 mm² miniblocks - 8 mm .315" spacing

Characteristics

Wire size		IEC		UL/CSA
mm ² / AWG		NFC DIN		
ADO	Solid	1 - 2.5 mm ²		16-14 AWG
	Stranded	1 - 2.5 mm ²		
Voltage		V	1000 V	600 V
Pulse		kV	—	—
Current		A	24 A	25 A
Rated wire size		mm ² / AWG	2.5 mm ²	14 AWG

Selection

Description	Type	Order P/N	Packaging	
DIN 3 miniblocks	grey <input type="checkbox"/>	DS 2,5/8.ADO	0299 501.03	100
	blue <input type="checkbox"/>	DS 2,5/8.N.ADO	0299 503.05	100
	orange <input type="checkbox"/>	DS 2,5/8.ADO	0299 502.04	100
	grey <input type="checkbox"/>	DSE 2,5/8.ADO	0299 559.14	20

* Notches to identify 8 mm spacing

Accessories

End stop V0		BADL	9 mm	0399 903.02	(screwless)	50
	light grey	BAM2	9.9 mm	0399 967.01	(with screw)	50
End section	grey V0 <input type="checkbox"/>	FEAD2	2.5 mm	0199 423.10		20
	orange V0 <input type="checkbox"/>	FEAD2	2.5 mm	0199 424.11		20

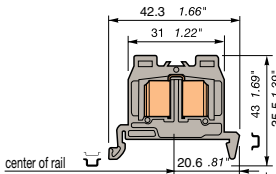

DS (with rib)
DSE (without rib
only for T.B.
assembly extremity)

DS 2,5/8.ADO

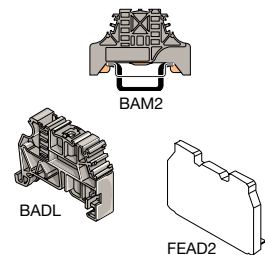



Miniblocks, feed through and ground

Insulation displacement

ADO - ADO, DIN 2

ADO - ADO

DR 1/5.ADO - 1 mm² miniblocks - 5 mm .198" spacing

Characteristics

Wire size mm ² / AWG	ADO	IEC		UL/CSA
		NFC	DIN	
		Solid	0.2 - 1 mm ²	24-18 AWG
		Stranded	0.22 - 1 mm ²	
Voltage		V	1000 V	600 V
Pulse		kV	8 kV	
Current		A	13.5 A	10 A
Rated wire size		mm ² / AWG	1 mm ²	18 AWG

2 wires of the same gauge and nature per ADO connection

Selection

Description	Type	Order P/N	Packaging
DIN 2 miniblocks	grey <input type="checkbox"/>	DR 1,5/6.ADO	0399 491.25
	blue <input type="checkbox"/>	DR 1,5/6.N.ADO	0399 493.27
	orange <input type="checkbox"/>	DR 1,5/6.ADO	0399 492.26
	grey <input type="checkbox"/>	DRE 1,5/6.ADO	0399 495.21

DR 1,5/6.ADO - 1.5 mm² miniblocks - 6 mm .236" spacing

Characteristics

Wire size mm ² / AWG	ADO	IEC		UL/CSA
		NFC	DIN	
		Solid	0.28 - 1.5 mm ²	22-16 AWG
		Stranded	0.34 - 1.5 mm ²	
Voltage		V	1000 V	600 V
Pulse		kV	8 kV	
Current		A	17.5 A	20 A
Rated wire size		mm ² / AWG	1.5 mm ²	16 AWG

2 wires of the same gauge and nature per ADO connection

Selection

Description	Type	Order P/N	Packaging
DIN 2 miniblocks	grey <input type="checkbox"/>	DR 1,5/6.ADO	0199 283.24
	blue <input type="checkbox"/>	DR 1,5/6.N.ADO	0199 285.26
	orange <input type="checkbox"/>	DR 1,5/6.ADO	0199 284.25
	grey <input type="checkbox"/>	DRE 1,5/6.ADO	0299 554.07

DR 2,5/8....ADO - 2,5 mm² miniblock - 8 mm .315" spacing

Characteristics

Wire size mm ² / AWG	ADO	IEC		UL/CSA
		NFC	DIN	
		Solid	1 - 2.5 mm ²	16-14 AWG
		Stranded	1 - 2.5 mm ²	
Voltage		V	1000 V	600 V
Pulse		kV	8 kV	
Current		A	24 A	25 A
Current short-circuit		A	300 A / 1s	
Rated wire size		mm ² / AWG	2.5 mm ²	14 AWG

2 wires of the same gauge and nature per ADO connection

Selection

Description	Type	Order P/N	Packaging	
DIN 2 miniblocks	grey <input type="checkbox"/>	DR 2,5/8.ADO	0199 287.20	
	blue <input type="checkbox"/>	DR 2,5/8.N.ADO	0199 289.02	
	orange <input type="checkbox"/>	DR 2,5/8.ADO	0199 288.01	
	grey <input type="checkbox"/>	DRE 2,5/8.ADO	0299 555.00	
				20
DIN 2 miniblock for ground wire connected to the mounting rail green body / yellow marking	<input type="checkbox"/>	DR 2,5/8.P.ADO	0299 633.06	100

Accessories

End stop		BADRL	6,5 mm	0199 420.21	50
End section V0	grey <input type="checkbox"/>	FEAD2	2.5 mm	0199 423.10	20
	orange <input type="checkbox"/>	FEAD2	2.5 mm	0199 424.11	20
Screwless jumper bar IP 20 (for DR 1,5/6.ADO only)	orange <input type="checkbox"/>	BJADO6.2	17.5 A	0205 974.06	20
		BJADO6.3	17.5 A	0205 975.07	20
		BJADO6.4	17.5 A	0205 976.00	20
		BJADO6.5	17.5 A	0205 977.01	20
		BJADO6.10	17.5 A	0205 982.27	10

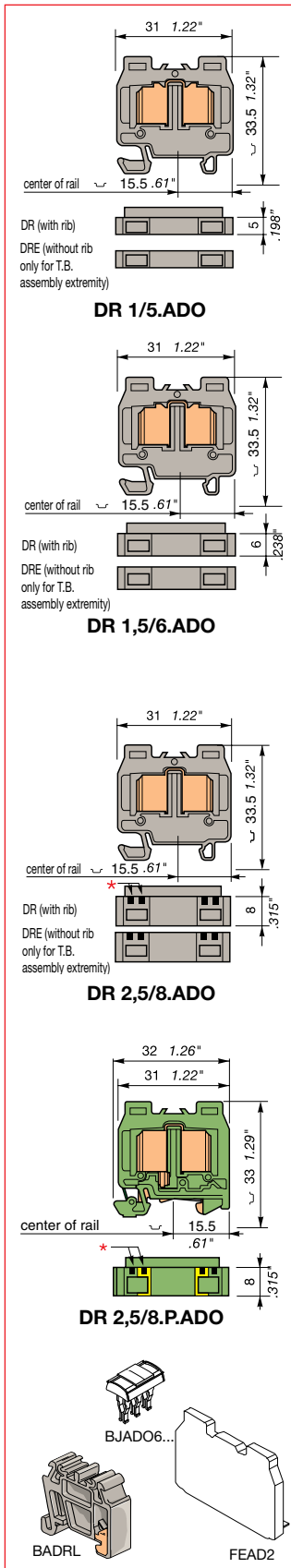

Miniblocks

Base mount with snap-in mounting foot

ADO - ADO

DH 1,5/6.ADO - 1.5 mm² miniblocks - 6 mm .236" spacing

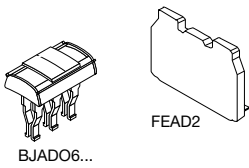
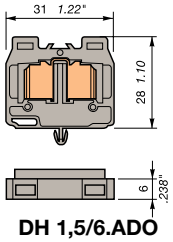

Characteristics		IEC		UL/CSA
		NFC	DIN	
Wire size mm ² / AWG	ADO	Solid	0.28 - 1.5 mm ²	22-16 AWG
		Stranded	0.34 - 1.5 mm ²	
Voltage		V	1000 V	600 V
Pulse		kV	8 kV	
Current		A	17.5 A	20 A
Rated wire size		mm ² / AWG	1.5 mm ²	16 AWG

Selection

Description	Type	Order P/N	Packaging	
Base mount miniblocks	grey <input type="checkbox"/>	DH 1,5/6.ADO	0299 529.06	100
with snap-in mounting	blue <input type="checkbox"/>	DH 1,5/6.N.ADO	0299 531.20	100
foot	orange <input type="checkbox"/>	DH 1,5/6.ADO	0299 530.03	100

Accessories

End section	grey V0 <input type="checkbox"/>	FEAD2	2.5 mm	0199 423.10	20
	orange V0 <input type="checkbox"/>	FEAD2	2.5 mm	0199 424.11	20
Screwless jumper bar IP 20	orange <input type="checkbox"/>				
	2 poles	BJJADO6.2	17.5 A	0205 974.06	20
	3 poles	BJJADO6.3	17.5 A	0205 975.07	20
	4 poles	BJJADO6.4	17.5 A	0205 976.00	20
	5 poles	BJJADO6.5	17.5 A	0205 977.01	20
10 poles	BJJADO6.10	17.5 A	0205 982.27	10	

DH 2,5/8.ADO - 2.5 mm² miniblocks - 8 mm .315" spacing

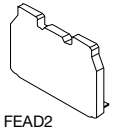
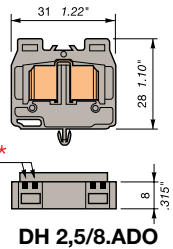

Characteristics		IEC		UL/CSA
		NFC	DIN	
Wire size mm ² / AWG	ADO	Solid	1 - 2.5 mm ²	16-14 AWG
		Stranded	1 - 2.5 mm ²	
Voltage		V	800 V	600 V
Pulse		kV	8 kV	
Current		A	24 A	25 A
Rated wire size		mm ² / AWG	2.5 mm ²	14 AWG

Selection

Description	Type	Order P/N	Packaging	
Base mount miniblocks	grey <input type="checkbox"/>	DH 2,5/8.ADO	0299 533.22	100
with snap-in mounting	blue <input type="checkbox"/>	DH 2,5/8.N.ADO	0299 535.24	100
foot	orange <input type="checkbox"/>	DH 2,5/8.ADO	0299 534.23	100

Accessories

End section	grey V0 <input type="checkbox"/>	FEAD2	2.5 mm	0199 423.10	20
	orange V0 <input type="checkbox"/>	FEAD2	2.5 mm	0199 424.11	20

DB 1,5/6.ADO - 1.5 mm² miniblocks - 6 mm .236" spacing

Characteristics

Wire size mm ² / AWG	ADO	IEC NFC DIN		UL/CSA
		Solid	0.28 - 1.5 mm ²	
		Stranded	0.34 - 1.5 mm ²	22-16 AWG
Voltage	V		1000 V	600 V
Pulse	kV		8 kV	
Current	A		17.5 A	20 A
Rated wire size	mm ² / AWG		1.5 mm ²	16 AWG

Selection

Description	Type	Order P/N	Packaging	
Base mount miniblocks	grey	DB 1,5/6.ADO	0299 513.26	100
with flanges	blue	DB 1,5/6.N.ADO	0299 515.20	100
	orange	DB 1,5/6.ADO	0299 514.27	100

Accessories

End section flanges (right + left)	grey	FEAD4	V0	0199 439.20	20
	orange	FEAD4	V0	0199 440.05	20
Screwless jumper bar IP 20	orange	BJADO6.2	17.5 A	0205 974.06	20
		BJADO6.3	17.5 A	0205 975.07	20
		BJADO6.4	17.5 A	0205 976.00	20
		BJADO6.5	17.5 A	0205 977.01	20
		BJADO6.10	17.5 A	0205 982.27	10

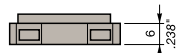
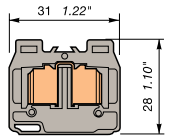

DB 1,5/6.ADO

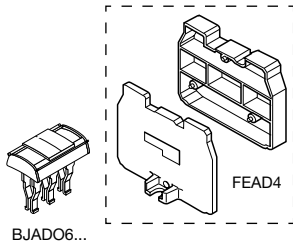

DB 2,5/8.ADO - 2.5 mm² miniblocks - 8 mm .315" spacing

Characteristics

Wire size mm ² / AWG	ADO	IEC NFC DIN		UL/CSA
		Solid	0.28 - 1.5 mm ²	
		Stranded	0.34 - 1.5 mm ²	22-16 AWG
Voltage	V		800 V	600 V
Pulse	kV		8 kV	
Current	A		24 A	25 A
Rated wire size	mm ² / AWG		2.5 mm ²	14 AWG

Selection

Description	Type	Order P/N	Packaging	
Base mount miniblocks	grey	DB 2,5/8.ADO	0299 517.22	100
with flanges	blue	DB 2,5/8.N.ADO	0299 519.04	100
	orange	DB 2,5/8.ADO	0299 518.03	100

Accessories

End section flanges (right + left)	grey	FEAD4	V0	0199 439.20	20
	orange	FEAD4	V0	0199 440.05	20

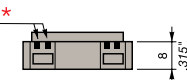
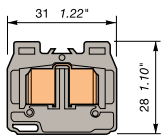

DB 2,5/8.ADO

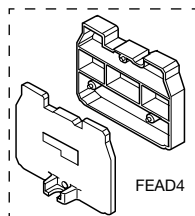

Accessories

Insulation displacement Tools and test connectors

Tools

- Connection time savings
- Connection security
- Vibration proof
- Corrosion proof

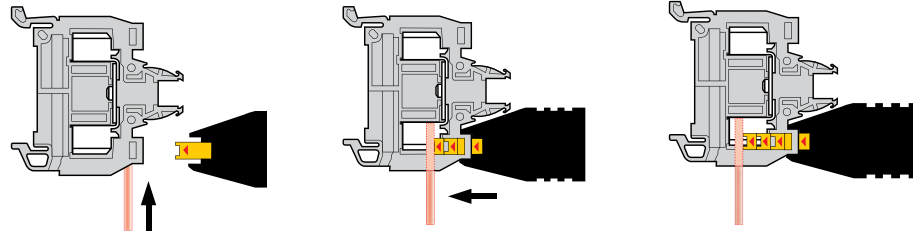

- 1 Position the wire (not stripped) in the opening on the side of the block.
- 2 Position the tool in the recess on top of the block.
- 3 Pull the trigger fully.

Description	Type	Order P/N	Packaging
Semi-automatic tool	OUPAD	0178 944.04	1
Wire extractor	EXAD	0178 646.11	1
Replacement head kit	OUTA	0205 284.03	1
Hand tool kit	OUMAD	0179 466.06	1
Pneumatic tool kit	OUTAD	0205 710.11	1
Extraction tool kit	EXAD2	0205 721.00	1

Test connectors on ADO jaw for terminal blocks

Test connectors on ADO jaw	CEADO.5 spacing 5 mm	0399 345.11	5
	CEADO.6 spacing 6 mm	0399 346.12	5
	CEADO.8 spacing 8 mm	0399 348.24	5
End module	CEADO.E th. 4.4 mm	0399 341.15	1
Assembly rod for lever	TGA.156 DIA. 3 mm	0206 277.14	1

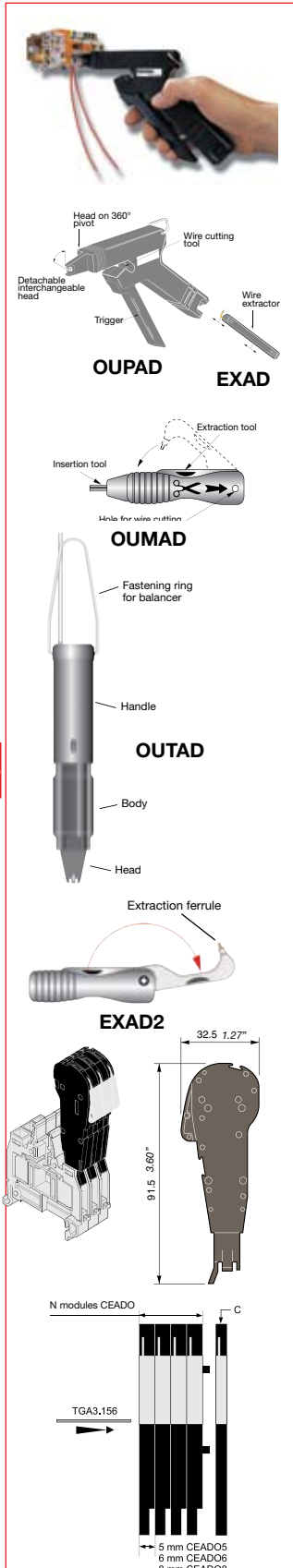

Power terminal blocks with bistable foot and base mounting, \sphericalangle DIN 3

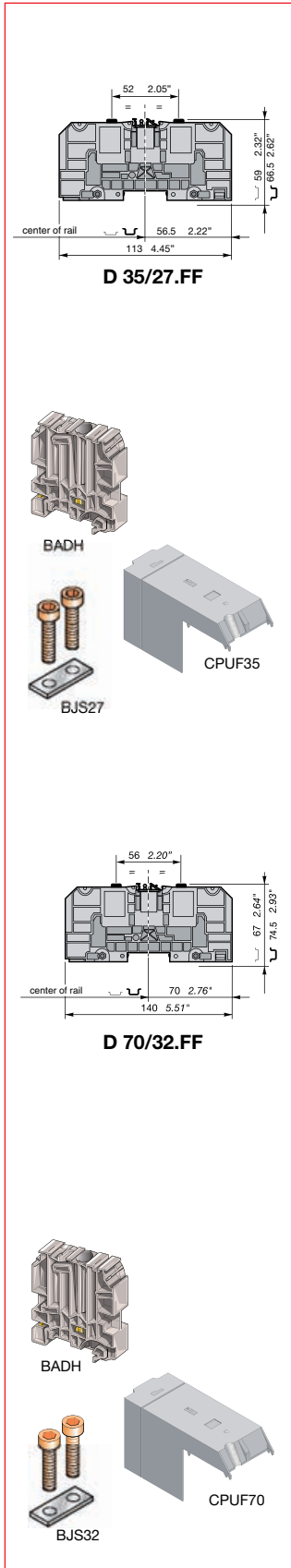

D 35/27.FF - 35 mm² blocks - 27 mm 1.06" spacing

Characteristics

		IEC		UL / CSA
		NFC ①	DIN ②	
Wire size mm ² / AWG	Lug solid wire	2.5 - 35	2.5 - 50	1 AWG max.
	C4* stranded wire	2.5 - 35	2.5 - 35	
Voltage	V	1000		600
Current	A	125		125
Rated wire size	mm ² / AWG	35 mm ²		1 AWG max.
Recommended wrench	Lug	H 10 mm		
	Central screw	6 mm Allen key		
Recommended torque	Lug	3 - 6 Nm / 26.1 - 52 lb.in		
	Central screw	6 - 12 Nm / 52 - 104 lb.in		

Selection

Description	Type	Order P/N	Packaging
Block 2 studs M6 without cover	grey V0 <input type="checkbox"/> D 35/27.FF	0190 001.20	10
Block 2 studs M6 delivered with two covers	grey V0 <input type="checkbox"/> D35/27.FF	0190 033.17	10

Accessories

End stop	BADH 12 mm	0116 900.27	50
Rotating protective cover IP20 V0 grey	<input type="checkbox"/> CPUF35	0190 016.16	10
Jumper bar with CHc screw	2 poles	BJS27	0205 772.13
	3 poles	BJS27	0205 773.14

D 70/32.FF - 70 mm² blocks - 32 mm 1.26" spacing

Characteristics

		IEC		UL / CSA
		NFC ①	DIN ②	
Wire size mm ² / AWG	Lug solid wire	6 - 95	6 - 70	000 AWG max.
	C6* stranded wire	6 - 70	6 - 70	
Voltage	V	1000		600
Current	A	192		170
Rated wire size	mm ² / AWG	70 mm ²		000 AWG max.
Recommended wrench	Lug	H 13 mm		
	Central screw	6 mm Allen key		
Recommended torque	Lug	6 - 12 Nm / 52 - 104 lb.in		
	Central screw	6 - 12 Nm / 52 - 104 lb.in		

Selection

Description	Type	Order P/N	Packaging
Block 2 studs M8 without cover	grey V0 <input type="checkbox"/> D 70/32.FF	0190 002.21	10
Block 2 studs M8 delivered with two covers	grey V0 <input type="checkbox"/> D 70/32.FF	0190 034.10	10

Accessories

End stop	BADH 12 mm	0116 900.27	50
Rotating protective cover IP20 V0 grey	<input type="checkbox"/> CPUF70	0190 017.17	10
Jumper bar with CHc screw	2 poles	BJS32	0205 774.15
	3 poles	BJS32	0205 775.16

① NFC 20130
② DIN 46234

Power terminal blocks

with bistable foot and base mounting, \mathcal{U} DIN 3

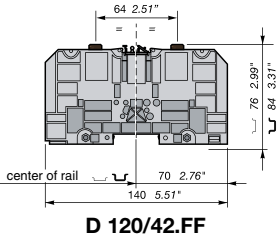

D 120/42.FF

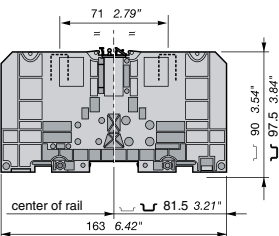

D 185/55.FF

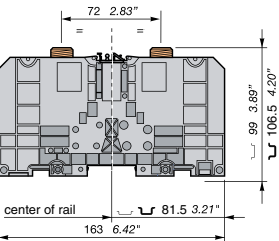

D 300/55.FF

D 120/42.FF - 120 mm² blocks - 42 mm 1.65" spacing

Characteristics

Characteristics		IEC		UL / CSA
		NFC ①	DIN ②	
Wire size mm ² /MCM	Lug Solid wire	6 - 150	6 - 120	300 MCM max.
	C8 Stranded wire	6 - 120	—	
Rated voltage	V	1000	600	
Rated current nominal	A	269	269	
Rated wire size nominal	mm ² / MCM	120 mm ²	300 MCM max.	
Recommended wrench	Lug	H 17 mm		
	Central screw	6 mm Allen key		
Recommended torque	Lug	10 - 20 Nm / 87 - 174 lb.in		
	Central screw	6 - 12 Nm / 52 - 104 lb.in		

D 185/55.FF - 185 mm² blocks - 55 mm 2.16" spacing

Characteristics

Characteristics		IEC		UL / CSA
		NFC ①	DIN ②	
Wire size mm ² /MCM	Lug Solid wire	25 - 240	6 - 185	500 MCM max.
	C11 Stranded wire	6 - 185	—	
Rated voltage	V	1000	600	
Rated current nominal	A	353	353	
Rated wire size nominal	mm ² / MCM	185 mm ²	500 MCM max.	
Recommended wrench	Lug	H 19 mm		
	Central screw	6 mm Allen key		
Recommended torque	Lug	14 - 30 Nm / 121 - 261 lb.in		
	Central screw	6 - 12 Nm / 52 - 104 lb.in		

D 300/55.FF - 300 mm² blocks - 55 mm 2.16" spacing

Characteristics

Characteristics		IEC		UL / CSA
		NFC ①	DIN ②	
Wire size mm ² / MCM	Lug Solid wire	25 - 300	6 - 300	1000 MCM max.
	C4 Stranded wire	6 - 300	—	
Voltage	V	1000	600	
Current	A	520	460	
Rated wire size	mm ² / MCM	300 mm ²	1000 MCM max.	
Recommended wrench	Lug	H 24 mm		
	Central screw	6 mm Allen key		
Recommended torque	Lug	25 - 50 Nm / 217 - 434 lb.in		
	Central screw	6 - 12 Nm / 52 - 104 lb.in		

Selection

Description	Type	Order P/N	Packaging
Standard block without cover			
grey V0	<input type="checkbox"/> D 120/42.FF	0190 003.22	5
Standard block delivered with two covers			
grey V0	<input type="checkbox"/> D 120/42.FF	0190 035.11	5
Standard block without cover			
grey V0	<input type="checkbox"/> D 185/55.FF	0190 004.23	5
Standard block delivered with two covers			
grey V0	<input type="checkbox"/> D 185/55.FF	0190 036.12	5
Block 2 studs M16 without cover			
grey V0	<input type="checkbox"/> D 300/55.FF	0190 005.24	5
Block 2 studs M16 delivered with two covers			
grey V0	<input type="checkbox"/> D 300/55.FF	0190 037.13	5

Accessories

End stop		BADH 12 mm	0116 900.27	50
Rotating protective cover IP 20				
grey V0	<input type="checkbox"/>	CPUF120 ③	0190 018.20	5
grey V0	<input type="checkbox"/>	CPUF185 ④	0190 019.21	5
Jumper bar	2 poles	BJS42 ③	0205 776.17	5
with ChC screws	3 poles	BJS42 ③	0205 777.10	5
Jumper bar	2 poles	BJS551 ④	0205 778.21	5
with ChC screws	3 poles	BJS551 ④	0205 779.22	5

① NFC 20130

② DIN 46234

③ Only for block D 120/42.FF

④ For blocks D 185/55.FF and D 300/55.FF

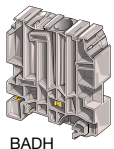

BADH

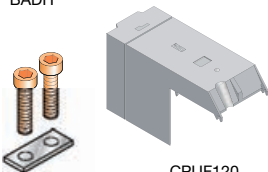

BJS42
BJS551

CPUF120
CPUF185

Power terminal blocks with bistable foot and base mounting, \sphericalangle DIN 3

D 35/27.AF - 35 mm² blocks - 27 mm 1.06" spacing

Characteristics

		IEC		UL / CSA
		NFC ①	DIN ②	
Wire size mm ²	Lug solid wire	2.5 - 35	2.5 - 50	—
	C4* stranded wire	2.5 - 35	2.5 - 35	12 - 1 AWG
	Wire-clamp solid wire	2.5 - 40	—	12 - 1 AWG
	IEC B9 stranded wire	2.5 - 35	—	
Voltage	V	1000		600
Current	A	125		130
Rated wire size	mm ²	35 mm ²		
Recommended wrench	Lug	H 10 mm		
	Central screw	6 mm Allen key		
	Wire-clamp	5 mm Allen key		
	Wire stripping length	28 mm / 1.10"		
	Wire stripping length	28 mm / 1.10"		
Recommended torque	Lug	3 - 6 Nm / 26 - 52 lb.in		
	Central screw	6 - 12 Nm / 52 - 104 lb.in		
	Wire-clamp	3 - 6 Nm / 26 - 52 lb.in		
	Wire stripping length	28 mm / 1.10"		

Selection

Description	Type	Order P/N	Packaging
Block 1 stud M6 + 1 wire-clamp with CHC M6 screw grey V0 <input type="checkbox"/>	D 35/27.AF	0190 006.25	10

Accessories

End stop	BADH 12 mm	0116 900.27	50
Rotating protective cover IP20 V0 grey <input type="checkbox"/>	CPUF35	0190 016.16	10
Jumper bar with CHC screw	2 poles	BJS27	0205 772.13
	3 poles	BJS27	0205 773.14

D 70/32.AF - 70 mm² blocks - 32 mm 1.26" spacing

Characteristics

		IEC		UL / CSA
		NFC ①	DIN ②	
Wire size mm ²	Lug solid wire	6 - 95	6 - 70	10 - 000 AWG
	C4* stranded wire	6 - 70	6 - 70	
	Wire-clamp solid wire	6 - 95	—	10 - 000 AWG
	IEC B9 stranded wire	6 - 70	—	
Voltage	V	1000		600
Current	A	192		165
Rated wire size	mm ²	70 mm ²		
Recommended wrench	Lug	H 13 mm		
	Central screw	6 mm Allen key		
	Wire-clamp	6 mm Allen key		
	Wire stripping length	33 mm / 1.30"		
	Wire stripping length	33 mm / 1.30"		
Recommended torque	Lug	6 - 12 Nm / 52 - 104 lb.in		
	Central screw	6 - 12 Nm / 52 - 104 lb.in		
	Wire-clamp	6 - 12 Nm / 52 - 104 lb.in		
	Wire stripping length	33 mm / 1.30"		

Selection

Description	Type	Order P/N	Packaging
Block 1 stud M8 + 1 wire-clamp with CHC M8 screw grey V0 <input type="checkbox"/>	D 70/32.AF	0190 007.26	10

Accessories

End stop	BADH 12 mm	0116 900.27	50
Rotating protective cover IP20 V0 grey <input type="checkbox"/>	CPUF70	0190 017.17	10
Jumper bar with CHC screw	2 poles	BJS32	0205 774.15
	3 poles	BJS32	0205 775.16

① NFC 20130
② DIN 46234

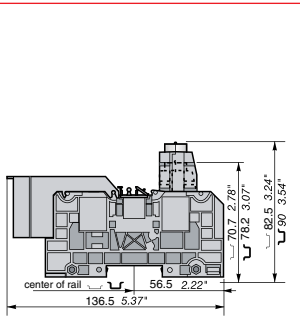

D 35/27.AF

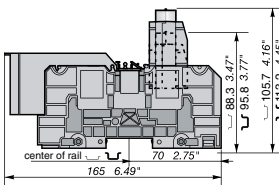
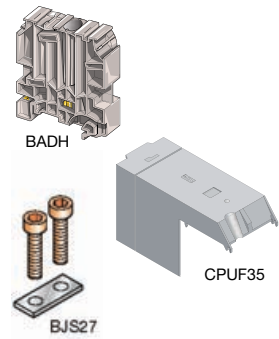

D 70/32.AF

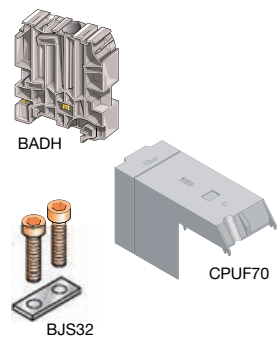

Power terminal blocks with bistable foot and base mounting, \mathcal{U} DIN 3

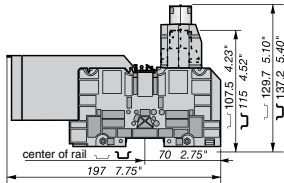

D 120/42.AF

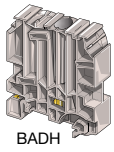

BADH

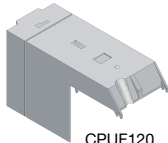

CPUF120



BJS42

D 120/42.AF - 120 mm² blocks - 42 mm 1.65" spacing

Characteristics		IEC		UL / CSA	
		NFC ①	DIN ②		
Wire size mm ²	Lug	solid wire	6-150	6-120	10 - 300 MCM
		stranded wire	6-120	6-120	
	Wire-clamp	solid wire	6-150	—	10 - 300 MCM
		IEC B13 stranded wire	6-120	—	
Rated voltage	V	1000	1000	600	
Rated current nominal	A	269	—	240	
Rated wire size nominal	mm ²	120	—	—	
Recommended wrench	Lug	H 17 mm			
	Central screw	6 mm Allen key			
	Wire-clamp	8 mm Allen key			
	Wire stripping length	38 mm / 1.50"			
Recommended torque	Lug	10 - 20 Nm / 87 - 174 lb.in			
	Central screw	6 - 12 Nm / 52 - 104 lb.in			
	Wire-clamp	10 - 20 Nm / 87 - 174 lb.in			
	Wire stripping length	38 mm / 1.50"			

Selection

Description	Type	Order P/N	Packaging
Standard block with cover			
grey V0	D 120/42.AF	0190 008.07	5
1 stud M10 + wire clamp with CHc M10 screw			

Accessories

End stop	BADH 12 mm	0116 900.27	50
Rotating protective cover IP20	grey V0 CPUF120	0190 018.20	5
Jumper bar	2 poles	BJS42	0205 776.17
	3 poles	BJS42	0205 777.10

D 185/55.AF - 185 mm² blocks - 55 mm 2.16" spacing

Characteristics		IEC		UL / CSA	
		NFC ①	DIN ②		
Wire size mm ²	Lug	solid wire	25-240	6-185	4 - 500 MCM
		stranded wire	6-185	6-185	
	Wire-clamp	solid wire	25-240	—	4 - 500 MCM
		IEC B15 stranded wire	25-185	—	
Rated voltage	V	1000	1000	600	
Rated current nominal	A	353	—	320	
Rated wire size nominal	mm ²	185	—	—	
Recommended wrench	Lug	H 19 mm			
	Central screw	6 mm Allen key			
	Wire-clamp	10 mm Allen key			
	Wire stripping length	47 mm / 1.85"			
Recommended torque	Lug	14 - 30 Nm / 121 - 260 lb.in			
	Central screw	6 - 12 Nm / 52 - 104 lb.in			
	Wire-clamp	14 - 20 Nm / 121 - 174 lb.in			
	Wire stripping length	47 mm / 1.85"			

Selection

Description	Type	Order P/N	Packaging
Standard block with cover			
grey V0	D 185/55.AF	0190 009.00	5
1 stud M12 + wire clamp with CHc M12 screw			

Accessories

End stop	BADH 12 mm	0116 900.27	50
Rotating protective cover IP20	grey V0 CPUF185	0190 019.21	5
Jumper bar	2 poles	BJS551	0205 778.21
	3 poles	BJS551	0205 779.22

① NFC 20130
② DIN 46234

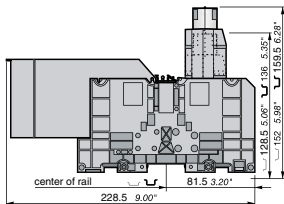

D 185/55.AF

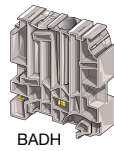

BADH

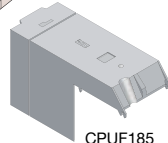

CPUF185



BJS551

Feed through terminal blocks

Screw clamp to quick-connect, DIN 1-3

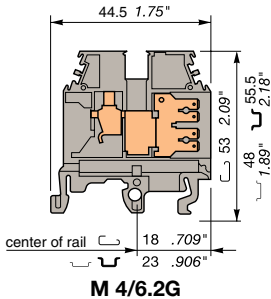

M 4/6.2G

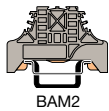

BAM2



FEM6G

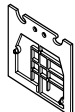

SCF6G

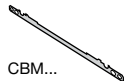

CBM...

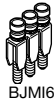

BJMI6

M 4/6.2G - 4 mm² blocks - 6 mm .236" spacing

Characteristics

		IEC NFC DIN	UL	CSA
Wire size (Screw clamp) mm ² / AWG	Solid	0.5 - 4 mm ²	22-10 AWG	24-12 AWG
	Stranded	0.5 - 4 mm ²		
Wire size (quick-connect) mm ² / AWG	Quick-connect	2.8 x 0.8 mm series 110 - 1.5 mm ² max. 6.3 x 0.8 mm series 250 - 2.5 mm ² max.		
Voltage	V	750 V Gr.C	600	300
Current	A	25	20	25
Rated wire size	mm ² / AWG	4 mm ²	10 AWG	12 AWG
Wire stripping length	mm / inches	9.5 mm / .374"		
Recommended torque	Nm / lb.in	0.4-0.6 Nm / 3.5-5.3 lb.in		

Selection

Description	Type	Order P/N	Packaging
Terminal block with partition. Output : Screw clamp to horizontal quick connect tabs			
grey	<input type="checkbox"/> M 4/6.2G	0115 189.11	50
blue	<input type="checkbox"/> M 4/6.2G.N	0125 189.13	50
beige V0	<input type="checkbox"/> M 4/6.2G.V0	0195 189.12	50

Accessories

End stop		BAM2	9.9 mm	0206 351.16	50
End section	grey	<input type="checkbox"/> FEM6G	2.5 mm	0113 027.07	20
	blue	<input type="checkbox"/> FEM6G	2.5 mm	0123 027.01	10
	beige V0	<input type="checkbox"/> FEM6G	2.5 mm	0193 027.00	20
Separator end section	grey	<input type="checkbox"/> SCF6G	3 mm	0113 075.17	20
Assembled jumper bar (with IP20 protection)	2 poles	BJMI6	32 A	0176 663.00	10
	3 poles	BJMI6	32 A	0176 664.01	10
	4 poles	BJMI6	32 A	0176 665.02	10
	5 poles	BJMI6	32 A	0176 666.03	10
	10 poles	BJMI6	32 A	0176 667.04	10
Shield connector		CBM5	0.5 mm	0178 745.14	50
		CBM8	0.8 mm	0178 746.15	50

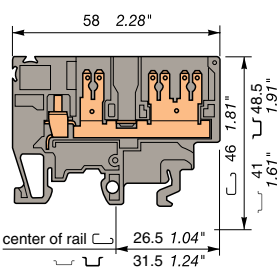

M 4/6.3G

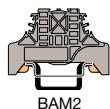

BAM2

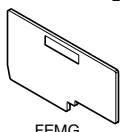

FEMG

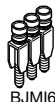

BJMI6

M 4/6.3G - 4 mm² blocks - 6 mm .236" spacing

Characteristics

		NFC DIN	UL	CSA
Wire size (Screw clamp) mm ² / AWG	Solid	0.2 - 4 mm ²	—	20-12 AWG
	Stranded	0.22 - 4 mm ²		
Wire size (quick-connect) mm ² / AWG	Quick-connect	2.8 x 0.8 mm series 110 - 1.5 mm ² max. 6.3 x 0.8 mm series 250 - 2.5 mm ² max.		
Voltage	V	500 V Gr.C	—	300
Current	A	25	—	25
Rated wire size	mm ² / AWG	4 mm ²	—	12 AWG
Wire stripping length	mm / inches	9.5 mm / .374"		
Recommended torque	Nm / lb.in	0.5-0.8 Nm / 4.4-7.1 lb.in		

Selection

Description	Type	Order P/N	Packaging
Terminal block with partition. Output : Screw clamp - vertical quick-connect tabs to vertical quick-connect tabs			
grey	<input type="checkbox"/> M 4/6.3G	0115 279.02	50

Accessories

End stop	grey	BAM2	9.9 mm	0206 351.16	50
End section	grey	<input type="checkbox"/> FEMG	1.5 mm	0114 144.12	25
Assembled jumper bar (with IP20 protection)	2 poles	BJMI6	32 A	0176 663.00	10
	3 poles	BJMI6	32 A	0176 664.01	10
	4 poles	BJMI6	32 A	0176 665.02	10
	5 poles	BJMI6	32 A	0176 666.03	10
	10 poles	BJMI6	32 A	0176 667.04	10

Quick-connect terminal blocks

Quick-connect to quick-connect, DIN 1-3

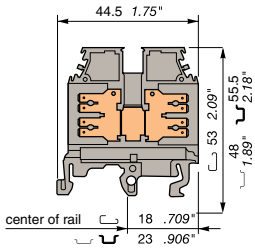

M 2,5/6.2G.2G

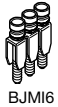
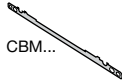
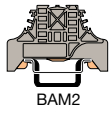

M 2,5/6.2G.2G - 2,5 mm² blocks - 6 mm .236" spacing

Characteristics

		IEC NFC DIN	UL	CSA
Wire size mm ² / AWG	Quick-connect	2.8 x 0.8 mm series 110 - 1.5 mm ² max. 6.3 x 0.8 mm series 250 - 2.5 mm ² max.		
Voltage	V	630	600	300
Current	A	20	25	20
Rated wire size	mm ² / AWG	2.5 mm ²	10 AWG	12 AWG

Selection

Description	Type	Order P/N	Packaging
Standard block, outputs : horizontal quick-connect tabs to horizontal quick-connect tabs			
grey <input type="checkbox"/>	M 2,5/6.2G.2G	0115 191.03	50
beige V0 <input type="checkbox"/>	M 2,5/6.2G.2G.V0	0195 191.04	50

Accessories

End stop	grey	BAM2	9.9 mm	0206 351.16	50
End section	grey <input type="checkbox"/>	FEM6G	2.5 mm	0113 027.07	20
	beige V0 <input type="checkbox"/>	FEM6G	2.5 mm	0193 027.00	20
Separator end section	grey <input type="checkbox"/>	SCF6G	3 mm	0113 075.17	20
	grey V0 <input type="checkbox"/>	SCF6G	3 mm	0193 075.10	20
Assembled jumper bar (with IP20 protection)	2 poles	BJMI6	32 A	0176 663.00	10
	3 poles	BJMI6	32 A	0176 664.01	10
	4 poles	BJMI6	32 A	0176 665.02	10
	5 poles	BJMI6	32 A	0176 666.03	10
	10 poles	BJMI6	32 A	0176 667.04	10
Shield connector		CBM5	0.5 mm	0178 745.14	50
		CBM8	0.8 mm	0178 746.15	50

M 2,5/6.4G.1 - 2,5 mm² blocks - 6 mm .236" spacing

Characteristics

		IEC NFC DIN	UL	CSA
Wire size mm ² / AWG	Quick-connect	2.8 x 0.8 mm series 110 - 1.5 mm ² max. 6.3 x 0.8 mm series 250 - 2.5 mm ² max.		
Voltage	V	630	600	300
Current	A	35	25	25
Rated wire size	mm ² / AWG	2.5 mm ²	10 AWG	12 AWG

Selection

Description	Type	Order P/N	Packaging
Terminal block with partition. Output : vertical quick-connect tabs to vertical quick-connect tabs			
grey <input type="checkbox"/>	M 2,5/6.4G.1	0115 280.20	50

Accessories

End stop	grey	BAM2	9.9 mm	0206 635.16	50
End section	grey <input type="checkbox"/>	FEMG	1,5 mm	0114 144.12	25
Assembled jumper bar (with IP20 protection)	2 poles	BJMI6	32 A	0176 663.00	10
	3 poles	BJMI6	32 A	0176 664.01	10
	4 poles	BJMI6	32 A	0176 665.02	10
	5 poles	BJMI6	32 A	0176 666.03	10
	10 poles	BJMI6	32 A	0176 667.04	10

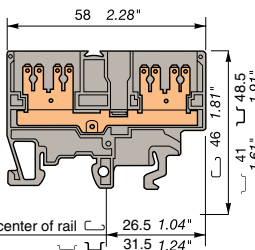

M 2,5/6.4G.1

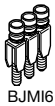
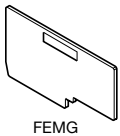
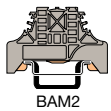

Railway applications

Terminal blocks with longitudinal quick connect tabs

Quick connect-Quick connect, 3 1/2 DIN 3 - reinforced rail type 2

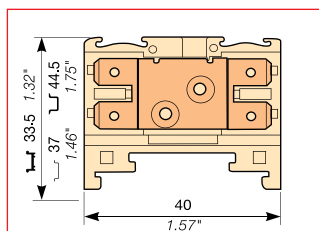

HD 2,5/6.2G.2G.1

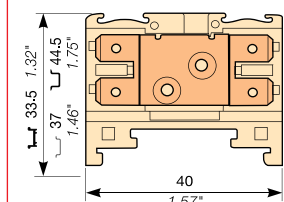

HD 6/8.2G.2G.1

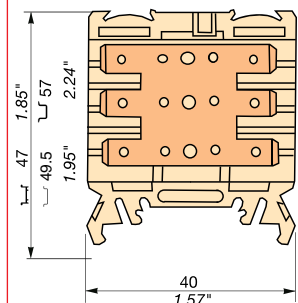
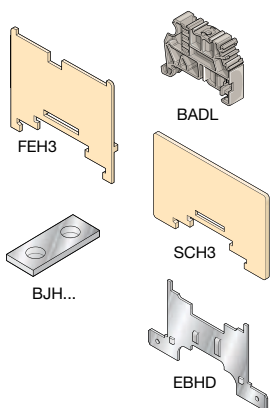

HD 2,5/6.3.3G.3G.1

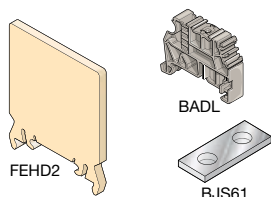

HD 2,5/6.2G.2G.1 - 2.5 mm² block - 6 mm spacing

Characteristics

		NFC	DIN
Wire size mm ²	Quick connect	6.3 x 0.8 mm (series 250) - 2.5 mm ² max.	
Voltage	V AC	250 Cat.C	125 Gr.C
Voltage	V DC	250 Cat. C	150 Gr.C
Rated current	A	20/25 A	26 A
Rated wire size	mm ²	2.5 mm ²	2.5 mm ²

HD 6/8.2G.2G.1 - 6 mm² block - 8 mm spacing

Characteristics

		NFC	DIN
Wire size mm ²	Quick connect	6.3 x 0.8 mm (series 250) - 6 mm ² max.	
Voltage	V AC	250	250 Gr.C
Voltage	V DC	250	300 Gr.C
Rated current	A	20/25 A	26 A
Rated wire size	mm ²	6 mm ²	6 mm ²

Selection

Description	Type	Order P/N	Packaging
Block with 4 quick connect tabs beige V0	HD 2,5/6.2G.2G.1	0160 487.25	50
Block with 4 quick connect tabs beige V0	HD 6/8.2G.2G.1	0160 606.14	50

Accessories

End stop V0	BADL	9 mm	0399 903.02	50
End section beige	FEH3	1 mm	0198 352.07	20
Circuit separator	SCH3	1.6 mm	0198 692.25	10
Prepunched jumper bar for HD 2,5/6.2G.2G.1	BJH6	2 poles	0168 481.23	10
	BJH6	3 poles	0168 482.24	10
	BJH6	4 poles	0168 483.25	10
	BJH6	5 poles	0168 484.26	10
	BJH6	10 poles	0168 485.27	10
Prepunched jumper bar for HD 6/8.2G.2G.1	BJH8	2 poles	0168 456.01	10
	BJH8	3 poles	0168 457.02	10
	BJH8	4 poles	0168 458.13	10
	BJH8	5 poles	0168 459.14	10
	BJH8	10 poles	0168 356.14	10
Shield connector	EBHD	1.6 mm	0168 353.11	1

HD 2,5/6.3.3G.3G.1 - 2.5 mm² block - 6 mm spacing

Characteristics

		NFC	DIN
Wire size mm ²	Quick connect	6.3 x 0.8 mm (series 250) - 2.5 mm ² max.	
Voltage	V AC	250 Cat.C	250 Gr.C
Voltage	V DC	250 Cat. C	300 Gr.C
Rated current	A	25 A	—
Rated wire size	mm ²	2.5 mm ²	—

Selection

Description	Type	Order P/N	Packaging
Block with 6 quick connect tabs beige	HD 2,5/6.3.3G.3G.1	0190 316.27	50

Accessories

End stop V0	BADL	9 mm	0399 903.02	50
End section beige	FEHD2	3 mm	0168 949.17	20
Prepunched jumper bar	BJS61	2 poles	0168 481.23	10
	BJS61	3 poles	0168 482.24	10
	BJS61	4 poles	0168 483.25	10
	BJS61	5 poles	0168 484.26	10
	BJS61	10 poles	0168 485.27	10

Railway applications

Terminal blocks w/ vertical and longitudinal quick connect tabs

Quick connect-Quick connect, U I DIN 3 - reinforced rail type 2

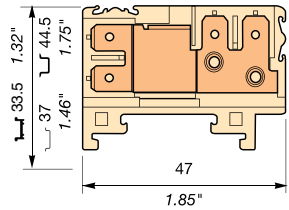

HD 6/8.2G.2G.2

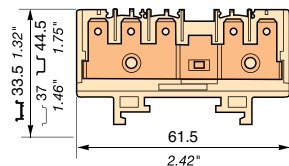

HD 6/9.5G

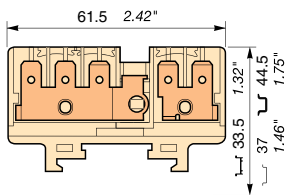

HD 6/9.3G.2G

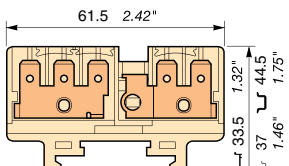

HD 6/9.2G.3G

HD 6/...G... - 6 mm² blocks - 8 or 9 mm .315" or .354" spacing

Characteristics

		DIN-VDE	NF F 61017	NFC-UTE
Wire size mm ²	Quick connect	6.3 x 0.8 mm (series 250) - 6 mm ² max.		
Voltage	V AC	380 Gr.C	380	400 Cat.C
Voltage	V DC	450 Gr. C	380	250 Cat.C
Rated current	A	26 A	20 A	20/25 A
Rated wire size	mm ²	6 mm ²	-	6 mm ²

Selection

Description	Type	Order P/N	Packaging
-------------	------	-----------	-----------

HD 6/8.2G.2G.2

- 1 circuit, 1 feed-through with 4 quick-connect tabs
- 2 longitudinal tabs
- 2 vertical tabs
- possible testing and transverse connection
- 8 mm spacing or 9 mm with end section

Quick-connect block	beige	 HD 6/8.2G.2G.2	0160 619.10	50
---------------------	-------	--------------------------------------------------------------------------------------------------	-------------	----

HD 6/9.5G

- 1 circuit, 5 quick-connect tabs
- 3 and 2 vertical tabs
- possible testing and transverse connection
- 9 mm spacing

Quick-connect block	beige	 HD 6/9.5G	0160 621.02	25
---------------------	-------	-----------------------------------------------------------------------------------------------	-------------	----

HD 6/9.3G.2G

- 2 circuits, 5 quick-connect tabs
- 1 feed-through with 3 vertical tabs and possible testing and transverse connection
- 1 feed-through with 2 vertical tabs and red marking
- 9 mm spacing



Quick-connect block	beige	 HD 6/9.3G.2G	0160 563.00	25
---------------------	-------	--------------------------------------------------------------------------------------------------	-------------	----

HD 6/9.2G.3G

- 2 circuits, 5 quick-connect tabs
- 1 feed-through with 3 vertical tabs and red marking
- 1 feed-through with 2 vertical tabs and possible testing and transverse connection
- 9 mm spacing

Quick-connect block	beige	 HD 6/9.2G.3G	0160 564.01	25
---------------------	-------	--------------------------------------------------------------------------------------------------	-------------	----

Accessories

End stop V0		BADL	9 mm	0399 903.02	50
End section for HD 6/8.2G.2G.2	beige	 FEH4	1 mm	0193 878.22	20
End section	beige	 FEHD1	1 mm	0199 400.06	20
Circuit separator for HD 6/8.2G.2G.2		SCH3	1,6 mm	0198 692.25	10
Prepunched jumper bar for HD 6/8.2G.2G.2		BJH8	2 poles	0168 456.01	10
		BJH8	3 poles	0168 457.02	10
		BJH8	4 poles	0168 458.13	10
		BJH8	5 poles	0168 459.14	10
		BJH8	10 poles	0168 356.14	10
Prepunched jumper bar for 9 mm blocks		BJH9	2 poles	0168 460.11	10
		BJH9	3 poles	0168 461.06	10
		BJH9	4 poles	0168 462.07	10
		BJH9	5 poles	0168 463.00	10
		BJH9	10 poles	0168 357.15	10

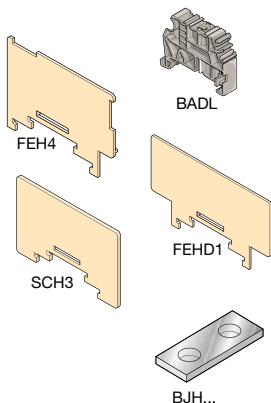

Railway applications

Component holders with tabs

Reinforced rail type 2, DIN 3

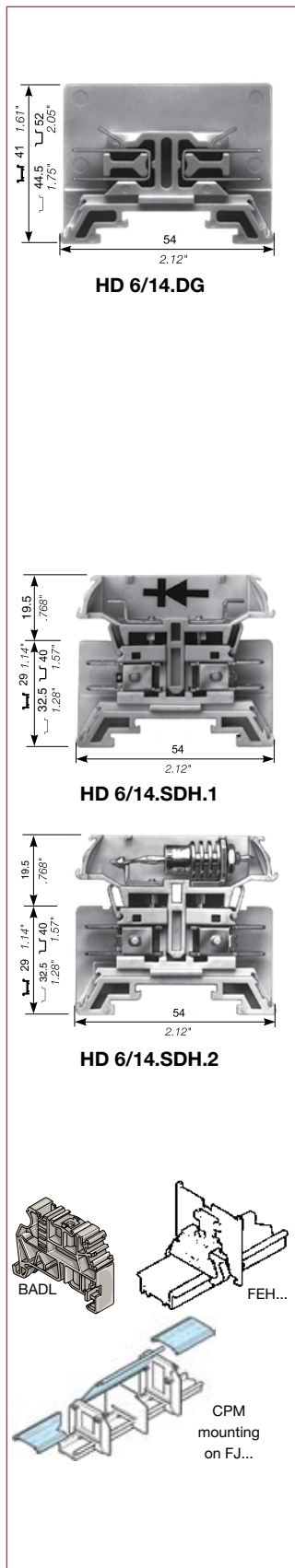

HD 6/14.DG - 6 mm² blocks - 14 mm .551" spacing

Characteristics		NFC	VDE	NF F 61017	NFC-UTE
Wire size mm ² / AWG	Quick-connect	6.3 x 0.8 mm (series 250) - 6 mm ²			
Voltage	V AC	500 Gr.C	380	500 Cat.C	
	V DC	600 Gr.C	500	500 Cat.C	
Current	A	26	12	20/25	
Rated wire size	mm ² / AWG	6 mm ²	—	6 mm ²	
Wire stripping length	mm / inches				
Recommended torque	Nm / lb.in				

Selection

Description	Type	Order P/N	Packaging
Block for soldered diodes or resistors, connection by 2 tabs for quick-connect 6.3x0.8 mm .248"x.031" on each side beige <input type="checkbox"/>	HD 6/14.DG	0162 309.10	10

HD 6/14.SDH... - 6 mm² blocks - 14 mm .551" spacing

Characteristics		NFC	VDE	NF F 61017	NFC-UTE
Wire size mm ² / AWG	Quick-connect	6.3 x 0.8 mm (series 250) - 6 mm ²			
Voltage	V AC	500Gr.C	380	500 Cat.C	
	V DC	600Gr.C	500	500 Cat.C	
Current	A	26	16	20/25	
Rated wire size	mm ² / AWG	6 mm ²	—	6 mm ²	
Wire stripping length	mm / inches				
Recommended torque	Nm / lb.in				

Selection

Description	Type	Order P/N	Packaging
Switch block for screw and soldered diodes, connection by 2 tabs for quick-connect 6.3x0.8 mm .248"x.031" on each side beige <input type="checkbox"/>	HD 6/14.SDH.1	0162 988.21	10
Switch block for screw and soldered diodes, without plug, connection by 2 tabs for quick-connect 6.3x0.8 mm .248"x.031" on each side beige <input type="checkbox"/>	HD 6/14.SDH	0162 993.16	10
Switch block for screw and soldered diodes, with plug, connection by 2 tabs for quick-connect 6.3x0.8 mm .248"x.031" on each side beige <input type="checkbox"/>	HD 6/14.SDH2	0162 972.20	10

Accessories

End stop	BADL	9 mm	0399 903.02	50
End section	grey <input type="checkbox"/>	FEH8 ①1.5 mm	0198 729.01	25
		FEH9 ②1.6 mm	0198 549.05	10
Intermediate section	FJH501	1.5 mm	0199 411.14	25
Circuit separator	SCH8	1.2 mm	0199 412.15	25
Clear cover	CPM		0187 312.14	1
	CPM		0197 312.16	1

① Only for HD 6/14.DG
② Only for HD 6/14.SDH...

Railway applications

Terminal blocks with 1 stud terminal

Reinforced rail type 2, DIN 3

HD 4/9.F4... - 4 mm² blocks - 10.7 mm .421" spacing

Characteristics



		NFC	
Wire size	Tubular lug (NFC 20130)	1.5 to 4 mm ²	
mm ² / AWG			
Voltage	V AC	500 Cat.C	
	V DC	500 Cat.C	
Current	A	32	
Rated wire size	mm ² / AWG	4 mm ²	
Wire stripping length	mm / inches		
Recommended torque	Nm / lb.in	1.2 Nm	

HD 4/9.F4 Selection

Description	Type	Order P/N	Packaging
Standard block	beige V0  HD 4/9.F4	0295 391.20	100

1 stud terminal M4x11.5 mm (.453") - Equipment : self locking nut + spring washer + washer

HD 4/9.F4.2 Selection

Description	Type	Order P/N	Packaging
Standard block brass	beige V0  HD 4/9.F4.2	0295 392.21	100
Standard block brass	yellow V0  HD 4/9.F4.2	0205 392.07	100

1 stud terminal M4x11.5 mm (.453") - Equipment : 1 bottom nut + 2 washers + 1 spring washer + 1 top nut

HD 10/12.F5... - 10 mm² blocks - 13.2 mm .520" spacing

Characteristics

		NFC	DIN
Wire size	Tubular lug (NFC 20130)	2.5 to 10 mm ²	
mm ² / AWG	Lug (DIN 46235)		6 to 10mm ²
Voltage	V AC	750 Cat.C	
	V DC	750 Cat.C	
Current	A	57	
Rated wire size	mm ² / AWG	10 mm ²	
Wire stripping length	mm / inches		
Recommended torque	Nm / lb.in	2.5 Nm (HD 10/12.F5) / 2 Nm	

HD 10/12.F5 Selection

Description	Type	Order P/N	Packaging
Standard block	beige V0  HD 10/12.F5	0295 394.23	50









1 stud terminal M5x19.5 mm (.768") - Equipment (As per NF F 61017) : self locking nut + TREP 3L washer + washer

HD 10/12.F5... Selection

Description	Type	Order P/N	Packaging
Standard block steel	beige V0  HD 10/12.F5.1	0295 395.24	50
Standard block brass	beige V0  HD 10/12.F5.2	0295 396.25	50
Standard block brass	yellow V0  HD 10/12.F5.2	0205 396.03	50

1 stud terminal M5x19.5 mm (.768") - Equipment : 1 bottom nut + 2 washers + 1 spring washer + 1 top nut

Accessories

Description	Type	Order P/N	Packaging
End stop	BADL 9 mm	0399 903.02	50
End section	beige V0  FJHD 32 ①1.5 mm	0295 431.10	25
	yellow V0  FJHD 32 ②1.5 mm	0205 431.26	25
	beige V0  FJHD40 ③1.5 mm	0295 424.11	25
	yellow V0  FJHD40 ④1.5 mm	0205 424.27	25
Double section (H : 40/50.5 mm)	FJDHD ③1.5 mm	0295 426.13	25
Circuit separator	beige V0  SCHD1 ①1.2 mm	0295 428.25	25
	yellow V0  SCHD1 ②1.2 mm	0205 428.03	25
	beige V0  SCHD2 ③1.2 mm	0295 429.26	25
	yellow V0  SCHD2 ④1.2 mm	0205 429.04	25
Jumper bar	10 poles	BJH105 ①10.5 mm	0163 503.24
	10 poles	BJH131 ③13.2 mm	0163 468.00

- ① For blocks : HD 4/9.F4, HD 4/9.F4.2
- ② For block : HD 4/9.F4.2
- ③ For blocks : HD 10/12.F5, HD 10/12.F5.1, HD 10/12.F5.2
- ④ For blocks : HD 10/12.F5.1, HD 10/12.F5.2

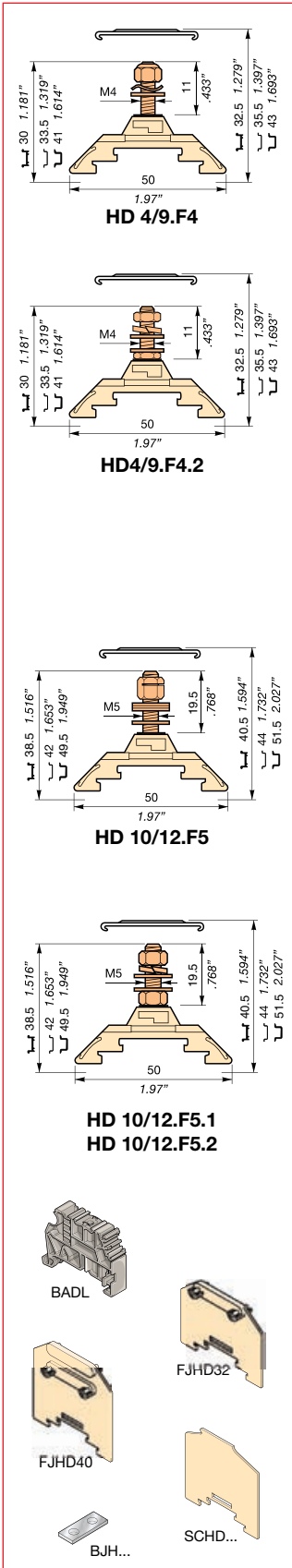

Railway applications

Terminal block with 1 stud terminal

Reinforced rail type 2, 𐀀 𐀁 DIN 3

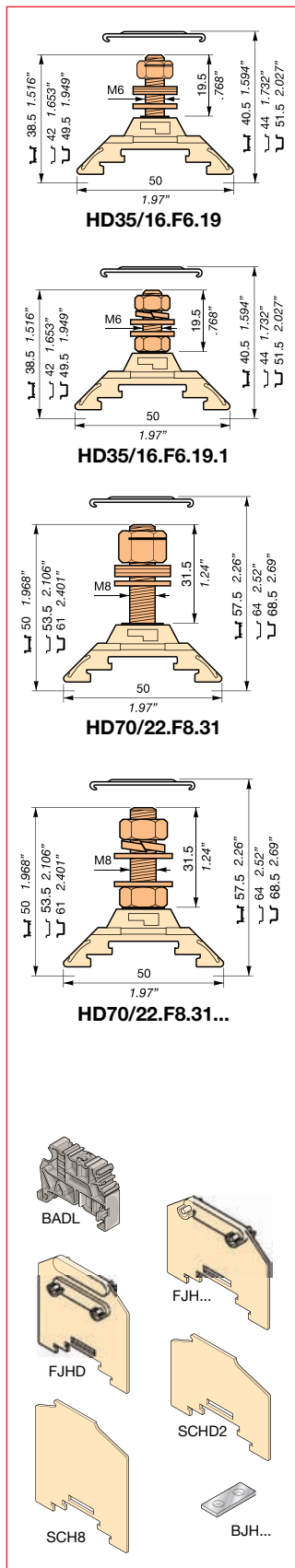

HD35/16.F6.19... - 35 mm² blocks - 17.2 mm .678" spacing

Characteristics

		NFC	DIN
Wire size	Tubular lug (NFC 20130)	4 to 35 mm ²	
mm ² / AWG	Lug (DIN 46235)		6 to 25 mm ²
Voltage	V AC	750 Cat.C	
	V DC	750 Cat.C	
Current	A	125	
Rated wire size	mm ² / AWG	35 mm ²	
Wire stripping length	mm / inches		
Recommended torque	Nm / lb.in	5.3 Nm (HD35/16.F6.19) / 3 Nm	

HD35/16.F6.19

Selection

Description	Type	Order P/N	Packaging
Standard block	beige V0 <input type="checkbox"/>	HD35/16.F6.19	50
1 stud terminal M6x19.5 mm (.768") - Equipment (as per NF F 61017) : H130 self locking nut + TREP 3L washer + washer			

HD35/16.F6.19.1

Selection

Description	Type	Order P/N	Packaging
Standard block	beige V0 <input type="checkbox"/>	HD35/16.F6.19.1	50
1 stud terminal M6x19.5 mm (.768") - Equipment : 1 bottom nut + 2 washers + 1 spring washer + 1 top nut			

HD70/22.F8.31... - 70 mm² blocks - 23.2 mm .914" spacing

Characteristics

		NFC	DIN
Wire size	Tubular lug (NFC 20130)	6 to 70 mm ²	
mm ² / AWG	Lug (DIN 46235)		16 to 50 mm ²
Voltage	V AC	750 Cat.C	
	V DC	750 Cat.C	
Current	A	192	
Rated wire size	mm ² / AWG	70 mm ²	
Wire stripping length	mm / inches		
Recommended torque	Nm / lb.in	13.4 Nm (HD70/22.F8.31) / 6 Nm	

HD70/22.F8.31

Selection

Description	Type	Order P/N	Packaging
Standard block	beige V0 <input type="checkbox"/>	HD70/22.F8.31	50
1 stud terminal M8x31.5 mm (1.24") - Equipment (as per NF F 61017) : H 130 self locking nut + TREP 3L washer + washer			

HD70/22.F8.31...

Selection

Description	Type	Order P/N	Packaging
Standard block steel	beige V0 <input type="checkbox"/>	HD70/22.F8.31.1	50
Standard block brass	beige V0 <input type="checkbox"/>	HD70/22.F8.31.2	50
1 stud terminal M8x31.5 mm (1.24") - Equipment : 1 bottom nut + 2 washers + 1 spring washer + 1 top nut			

Accessories

End stop	BADL	9 mm	0399 903.02	50
End section	beige V0 <input type="checkbox"/>	FJHD40 ① 1.5 mm	0295 424.11	25
	beige V0 <input type="checkbox"/>	FJH501 ② 1.5 mm	0199 411.14	25
Double section (H : 40/50.5 mm)	FJDHD ① 1.5 mm	0295 426.13	25	
Circuit separator	beige V0 <input type="checkbox"/>	SCHD2 ① 1.2 mm	0295 429.26	25
	beige V0 <input type="checkbox"/>	SCH8 ② 1.2 mm	0199 412.15	25
Jumper bar	10 poles	BJH17 ① 17.2 mm	0163 475.27	1
	10 poles	BJH23 ② 23.2 mm	0163 476.20	1

① For blocks : HD35/16.F6.19 and HD35/16.F6.19.1

② For blocks : HD70/22.F8.31, HD70/22.F8.31.1 and HD70/22.F8.31.2

Railway applications

Terminal block with 1 stud terminal

Reinforced rail type 2, 1 1/2 U DIN 3

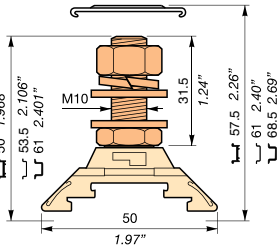

HD120/30.F10.31.1

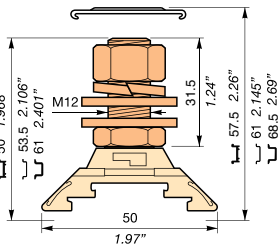

HD185/36.F12.31.1

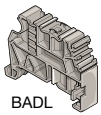

BADL

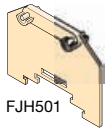

FJH501

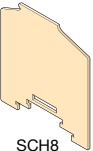

SCH8



BJH...

HD120/30.F10.31.1 - 120 mm² block - 31.2 mm 1.23" spacing

Characteristics

		NFC	DIN
Wire size	Tubular lug (NFC 20130)	10 to 120 mm ²	
mm ² / AWG	Lug (DIN 46235)		16 to 95 mm ²
Voltage	V AC	750 Cat.C	
	V DC	750 Cat.C	
Current	A	269	
Rated wire size	mm ² / AWG	120 mm ²	
Wire stripping length	mm / inches		
Recommended torque	Nm / lb.in	10 Nm	

Selection

Description	Type	Order P/N	Packaging	
Standard block	beige V0 <input type="checkbox"/>	HD120/30.F10.31.1	0295 403.25	10

1 stud terminal M10x31.5 mm (1.24") - Equipment : 1 bottom nut + 2 washers + 1 spring washer + 1 top nut

HD185/36.F12.31.1 - 185 mm² block - 37.2 mm 1.46" spacing

Characteristics

		NFC	DIN
Wire size	Tubular lug (NFC 20130)	50 to 185 mm ²	
mm ² / AWG	Lug (DIN 46235)		50 to 185 mm ²
Voltage	V AC	750 Cat.C	
	V DC	750 Cat.C	
Current	A	353	
Rated wire size	mm ² / AWG	185 mm ²	
Wire stripping length	mm / inches		
Recommended torque	Nm / lb.in	14 Nm	

Selection

Description	Type	Order P/N	Packaging	
Standard block	beige V0 <input type="checkbox"/>	HD185/36.F12.31.1	0295 405.27	10

1 stud terminal M12x31.5 mm (1.24") - Equipment : 1 bottom nut + 2 washers + 1 spring washer + 1 top nut

Accessories

End stop	BADL	9 mm	0399 903.02	50	
End section	beige V0 <input type="checkbox"/>	FJH501	1.5 mm	0199 411.14	25
Circuit separator	beige V0 <input type="checkbox"/>	SCH8	1.2 mm	0199 412.15	25
Jumper bar	10 poles	BJH311	⓪ 31.2 mm	0163 479.03	1
	10 poles	BJH23	⓪ 37.2 mm	0163 476.20	1

⓪ For block HD120/30.F10.31.1

⓪ For block HD185/36.F12.31.1

Railway applications

Terminal block with 2 stud terminals

Reinforced rail type 2, DIN 3

HD4/9.FF4 - 4 mm² block - 10.7 mm .421" spacing

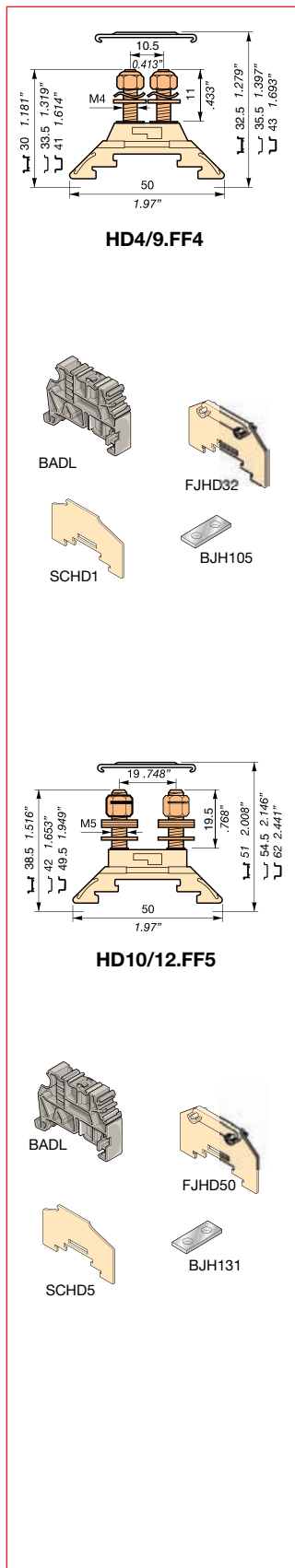

Characteristics



		NFC	
Wire size mm ² / AWG	Tubular lug (NFC 20130)	1.5 to 4 mm ²	
Voltage	V AC	500 Cat.C	
	V DC	500 Cat.C	
Current	A	32	
Rated wire size	mm ² / AWG	4 mm ²	
Recommended torque	Nm / lb.in	1.2 Nm	

Selection

Description	Type	Order P/N	Packaging
Standard block	beige V0  HD4/9.FF4	0295 393.22	100

2 stud terminals M4x11.5 mm (.453") - Equipment : self locking nut + spring washer + washer

Accessories

End stop	BADL 9 mm	0399 903.02	50
End section	beige V0  FJHD32 1.5 mm	0295 431.10	25
Circuit separator	beige V0  SCHED1 1.2 mm	0295 428.25	25
Jumper bar	10 poles BJH105 10.5 mm	0163 503.24	1

HD10/12.FF5 - 10 mm² block - 12 mm .473" spacing

Characteristics



		NFC	DIN
Wire size mm ² / AWG	Tubular lug (NFC 20130) Lug (DIN 46235)	2.5 to 10 mm ²	6 to 10 mm ²
Voltage	V AC	750 Cat.C	—
	V DC	750 Cat.C	—
Current	A	57	—
Rated wire size	mm ² / AWG	10 mm ²	—
Recommended torque	Nm / lb.in	2.5 Nm	

Selection

Description	Type	Order P/N	Packaging
Standard block	beige V0  HD10/12.FF5	0295 397.26	50

2 stud terminals M5x19.5 mm (.768") - Equipment : H 130 self locking nut + TREP 3L washer + washer

Accessories

End stop	BADL 9 mm	0399 903.02	50
End section	beige V0  FJHD50 1.5 mm	0295 425.12	25
Circuit separator	beige V0  SCHED5 1.2 mm	0295 430.23	25
Jumper bar	10 poles BJH131 13.2 mm	0163 468.00	1

Railway applications

Terminal blocks with 2 stud terminals

Reinforced rail type 2, DIN 3

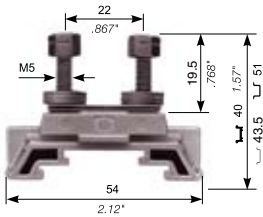

HD 16/14.FF5.21

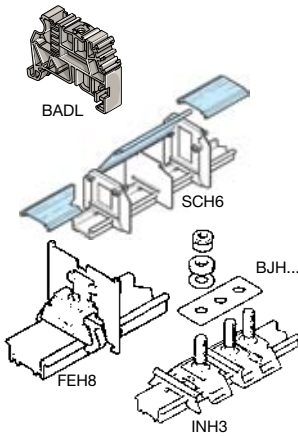

HD 16/14.FF5.21 - 16 mm² block - 14 mm .551" spacing

Characteristics



		NFC	VDE	NF F 61017	NFC-UTE
Wire size mm ² / AWG	Lugs	25 mm ² max.			
Voltage	V AC	500Gr.C	380/380	500 Cat.C	
	V DC	600Gr.C	500/500	500 Cat.C	
Current	A	65	51/71	71	
Rated wire size	mm ² / AWG	16 mm ²		16 mm ²	
Recommended torque	Nm / lb.in	2.5 Nm			

Selection

Description	Type	Type	Order P/N	Packaging
Standard block	beige V0 	HD 16/14.FF5.21	0162 991.14	25

2 stud terminals M5x19.5 mm (.768") with interruptor bar and possibility of transverse connection - Equipment (as per NF F 61017) : self locking nut + spring washer + washer

Accessories

End stop		BADL	9 mm	0399 903.02	50
End section	beige V0 	FEH8	1.5 mm	0198 729.01	25
Circuit separator	beige V0 	SCH6	4 mm	0199 393.22	20
Jumper bar 14 mm	2 poles	BJH14		0173 438.24	1
	3 poles	BJH14		0173 439.25	1
	4 poles	BJH14		0173 441.27	1
	5 poles	BJH14		0173 449.07	1
	10 poles	BJH14		0173 451.21	1
Jumper bar 18 mm (spacer placed between 2 blocks for 18 mm .708" spacing)	2 poles	BJH18		0173 452.22	1
	3 poles	BJH18		0173 453.23	1
	4 poles	BJH18		0173 454.24	1
	5 poles	BJH18		0173 460.06	1
	10 poles	BJH18		0173 461.23	1
Spacer		INH3	4 mm	0199 394.23	25

HD 16/14.FF5.20 - 16 mm² block - 14 mm .551" spacing

Characteristics

		NFC	VDE	NF F 61017	NFC-UTE
Wire size mm ² / AWG	Lugs	16 mm ² max.			
Voltage	V AC	500 Gr.C	380	500 Cat.C	
	V DC	600 Gr.C	500	500 Cat.C	
Current	A	65	51	71	
Rated wire size	mm ² / AWG	16 mm ²		16 mm ²	
Recommended torque	Nm / lb.in	2.5 Nm			

Selection

Description	Type	Type	Order P/N	Packaging
Standard block	beige V0 	HD 16/14.FF5.20	0162 979.07	25

2 stud terminals M5x19.5 mm (.768") with interruptor bar - Equipment (as per NF F 61017) : self locking nut + spring washer + washer

Accessories

End stop		BADL	9 mm	0399 903.02	50
End section	beige V0 	FEH8	1.5 mm	0198 729.01	25

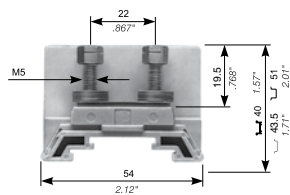

HD 16/14.FF5.20

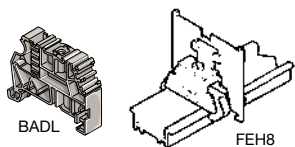

D 1,5/6.ADO.NF - 1.5 mm² blocks - 6 mm .236" spacing

Characteristics

		NF F 63-808		
Wire size		ADO		
mm ² / AWG		0.6 - 1.34 mm ²		
		IEC	NF F	UL/CSA
		NFE	61-017	
Voltage	V AC	1000	500	600
	V DC	1000	500	600
Current	A	17,5	17,5	18
Body weight	g / lb	3.5 g / 0.008 lb		
Metallic part weight	g / lb	3.23 g / 0.007 lb		
Total weight	g / lb	6.73 g / 0.015 lb		

Selection

Description	Type	Order P/N	Packaging	
Standard block	beige V0	D 1,5/6.ADO.NF	0399 730.17	50

Red marking to identify wire size

Accessories

End stop		BADL	9 mm	0399 903.02	(screwless)	50
	light grey	BAM2	9.9 mm	0399 967.01	(with screw)	50
End section	beige	FEMAD3	3 mm	0399 802.05		20
Circuit separator		SCAD		0196 896.00		10
Screwless jumper bar	2 poles	BJADO 6.2	17.5 A	0205 974.06		20
	3 poles	BJADO 6.3	17.5 A	0205 975.07		20
	4 poles	BJADO 6.4	17.5 A	0205 976.00		20
	5 poles	BJADO 6.5	17.5 A	0205 977.01		20
	10 poles	BJADO 6.10	17.5 A	0205 982.27		10
Shield connector		CBM5	0.5 mm	0178 745.14		50
		CBM8	0.8 mm	0178 746.15		50

D 2,5/8.ADO.NF - 2.5 mm² blocks - 8 mm .315" spacing

Characteristics

		NF F 63-808		
Wire size		ADO		
mm ² / AWG		0.93 - 2.61 mm ²		
		IEC	NF F	UL/CSA
		NFE	61-017	
Voltage	V AC	1000	500	600
	V DC	1000	500	600
Current	A	24	24	25
Body weight	g / lb	4.63 g / 0.010 lb		
Metallic part weight	g / lb	4.53 g / 0.009 lb		
Total weight	g / lb	9.16 g / 0.020 lb		

Selection

Description	Type	Order P/N	Packaging	
Standard block	beige V0	D 2,5/8.ADO.NF	0399 736.01	50

Blue marking to identify wire size

Accessories

End stop		BADL	9 mm	0399 903.02	(screwless)	50
	light grey	BAM2	9.9 mm	0399 967.01	(with screw)	50
End section	beige	FEMAD3	3 mm	0399 802.05		20
Circuit separator		SCAD		0196 896.00		10

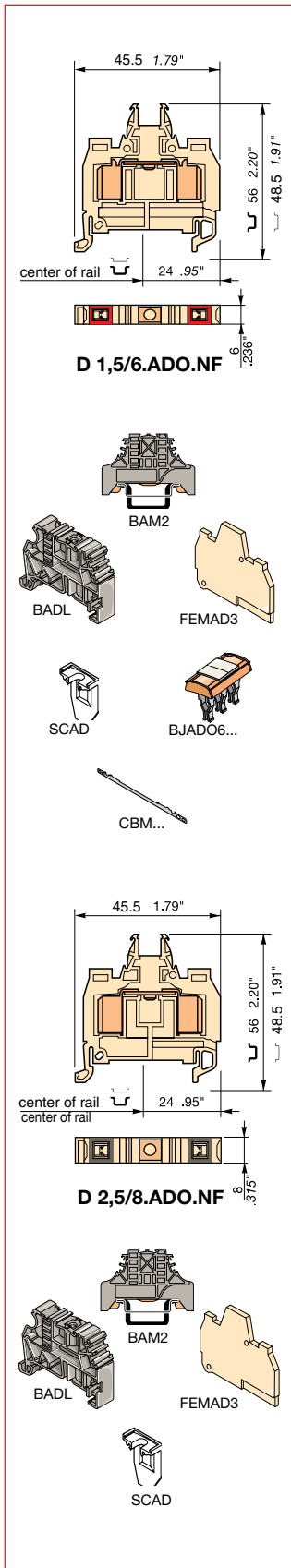

Railway applications

Terminal blocks with insulation displacement

ADO - ADO \curvearrowright DIN 3

D 4/8.ADO.NF - 4 mm² blocks - 8 mm .315" spacing

Characteristics

		NF F 63-808		
Wire size	ADO	2.61 - 4.32 mm ²		
mm ² / AWG				
		IEC NFE DIN	NF F 61-017	UL/CSA
Voltage	V AC	1000		600
	V DC	1000		600
Current	A	32	25	25
Body weight	g / lb	4.5 g / 0.01 lb		
Metallic part weight	g / lb	4.5 g / 0.01 lb		
Total weight	g / lb	9 g / 0.02 lb		

Selection

Description	Type	Order P/N	Packaging
Standard block	beige V0 \square D 4/8.ADO.NF	0399 748.25	50

Yellow marking to identify wire size

Accessories

End stop	BADL	9 mm	0399 903.02	(screwless)	50
	light grey BAM2	9.9 mm	0399 967.01	(with screw)	50
End section	beige \square FEMAD3	3 mm	0399 802.05		20
Circuit separator	SCAD		0196 896.00		10

D 2,5/8.ADO.NF1 - 2.5 mm² blocks - 8 mm .315" spacing

Characteristics

		NF F 65-296 NF F 63-826		
Wire size	ADO	1.5 mm ²		
mm ² / AWG				
		IEC NFE DIN	NF F 61-017	UL/CSA
Voltage	V AC	1000		600
	V DC	1000		600
Current	A	24	24	25
Body weight	g / lb	4.63 g / 0.010 lb		
Metallic part weight	g / lb	4.53 g / 0.009 lb		
Total weight	g / lb	9.16 g / 0.019 lb		

Selection

Description	Type	Order P/N	Packaging
Standard block	beige V0 \square D 2,5/8.ADO.NF1	0399 749.26	50

Black marking to identify wire size

Accessories

End stop	BADL	9 mm	0399 903.02	(screwless)	50
	light grey BAM2	9.9 mm	0399 967.01	(with screw)	50
End section	beige \square FEMAD3	3 mm	0399 802.05		20

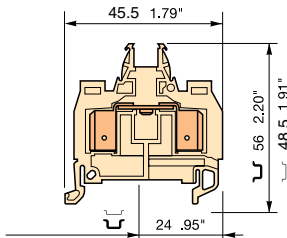

D 4/8.ADO.NF

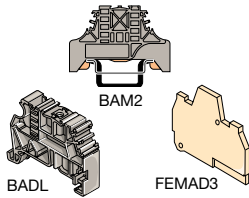

SCAD

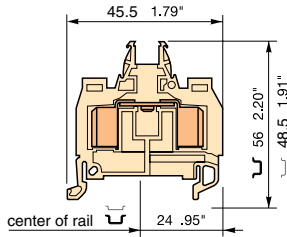

D 2,5/8.ADO.NF1

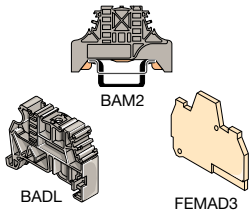

D 1,5/6.S.ADO.NF - 1.5 mm² blocks - 6 mm .236" spacing

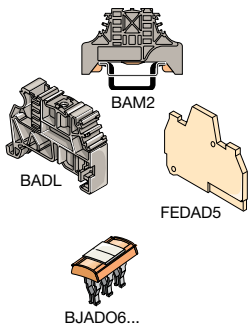
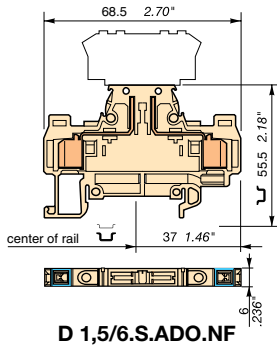

Characteristics

		NF F 63-808		
Wire size	ADO	0.6 - 1.34 mm ²		
mm ² / AWG				
		IEC NFE DIN	NF F 61-017	UL/CSA
Voltage	V AC	500		
	V DC	500		
Current	A	10		
Body weight	g / lb	6.48 g / 0.014 lb		
Metallic part weight	g / lb	4.76 g / 0.010 lb		
Total weight	g / lb	11.25 g / 0.025 lb		

Selection

Description	Type	Order P/N	Packaging
Standard block beige V0 <input type="checkbox"/>	D 1,5/6.S.ADO.NF	0400 083.25	50

Red marking to identify wire size

Accessories

End stop		BADL	9 mm	0399 903.02	(screwless)	50
	light grey	BAM2	9.9 mm	0399 967.01	(with screw)	50
End section	beige <input type="checkbox"/>	FEDAD5	2 mm	0399 804.07		20
Screwless jumper bar	2 poles	BJADO 6.2	17.5 A	0205 974.06		20
	3 poles	BJADO 6.3	17.5 A	0205 975.07		20
	4 poles	BJADO 6.4	17.5 A	0205 976.00		20
	5 poles	BJADO 6.5	17.5 A	0205 977.01		20
	10 poles	BJADO 6.10	17.5 A	0205 982.27		10

D 2,5/8.S.ADO.NF - 2.5 mm² blocks - 8 mm .315" spacing

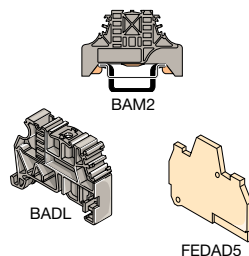
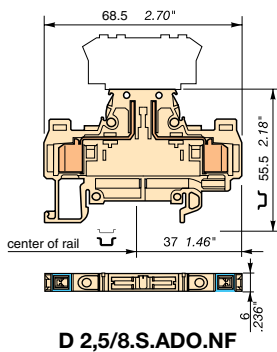

Characteristics

		NF F 63-808		
Wire size	ADO	0.93 - 2.61 mm ²		
mm ² / AWG				
		IEC NFE DIN	NF F 61-017	UL/CSA
Voltage	V AC	500		600
	V DC	500		600
Current	A	15		15
Body weight	g / lb	6.48 g / 0.014 lb		
Metallic part weight	g / lb	4.76 g / 0.010 lb		
Total weight	g / lb	11.25 g / 0.025 lb		

Selection

Description	Type	Order P/N	Packaging
Standard block beige V0 <input type="checkbox"/>	D 2,5/8.S.ADO.NF	0399 752.11	50

Blue marking to identify wire size

Accessories

End stop		BADL	9 mm	0399 903.02	(screwless)	50
	light grey	BAM2	9.9 mm	0399 967.01	(with screw)	50
End section	beige <input type="checkbox"/>	FEDAD5	2 mm	0399 804.07		20

Pluggable terminal blocks

Screw clamp, DIN 1-3

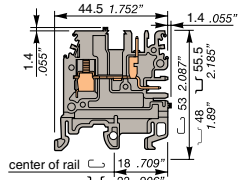

MA 2,5/5.CPE...

MA 2,5/5.CPE... - 2,5 mm² block - 5.08 mm .200" spacing

Characteristics		IEC NFC VDE	UL	CSA
Wire size mm ² / AWG	Solid	0.2 - 4 mm ²	24-12 AWG	24-12 AWG
	Stranded	0.22 - 2.5 mm ²		
Voltage	V	320(t)	300	300
Current	A	24/12+12	20/10+10	20/10+10
Rated wire size	mm ² / AWG	2.5 mm ²	12 AWG	12 AWG
Wire stripping length	mm / inches	8.5 mm / .33"		
Recommended torque	Nm / lb.in	0.4-0.6 Nm / 3.5-5.3 lb.in		

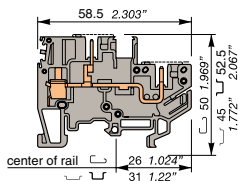

MA 2,5/5.2CPE

MA 2,5/5.2CPE... - 2,5 mm² block - 5.08 mm .200" spacing

Characteristics		IEC NFC VDE	UL	CSA
Wire size mm ² / AWG	Solid	0.2 - 4 mm ²	24-12 AWG	24-12 AWG
	Stranded	0.22 - 2.5 mm ²		
Voltage	V	320	300	300
Current	A	24/12+12	20/10+10	20/10+10
Rated wire size	mm ² / AWG	2.5 mm ²	12 AWG	12 AWG
Wire stripping length	mm / inches	10 mm / .394"		
Recommended torque	Nm / lb.in	0.4-0.6 Nm / 3.5-5.3 lb.in		

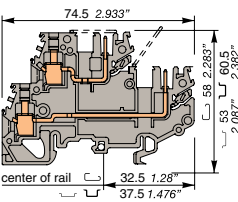

MA 2,5/5D2.2CPE

MA 2,5/5D2.2CPE... - 2,5 mm² block - 5.08 mm .200" spacing

Characteristics		IEC NFC VDE	UL	CSA
Wire size mm ² / AWG	Solid	0.2 - 4 mm ²	24-12 AWG	24-12 AWG
	Stranded	0.22 - 2.5 mm ²		
Voltage	V	320	300	300
Current	A	12/12	10/10	10/10
Rated wire size	mm ² / AWG	2.5 mm ²	12 AWG	12 AWG
Wire stripping length	mm / inches	10 mm / .394"		
Recommended torque	Nm / lb.in	0.4-0.6 Nm / 3.5-5.3 lb.in		

Selection

Description	Type	Order P/N	Packaging	
Standard block grey	<input type="checkbox"/>	MA 2,5/5.CPE	0115 957.12	50
Block equipped with 1 red Led 24V 4,8mA grey	<input type="checkbox"/>	MA 2,5/5.CPE-L24	0115 959.24	50
Block equipped with 1 diode 1N 4007 blue	<input type="checkbox"/>	MA 2,5/5.CPE-D	0125 960.23	50
Standard block grey	<input type="checkbox"/>	MA 2,5/5.2CPE	0115 964.11	50
Standard block blue	<input type="checkbox"/>	MA 2,5/5.2CPE	0125 711.15	50
Double deck block with 2 independant levels grey	<input type="checkbox"/>	MA 2,5/5D2.2CPE	0115 961.16	50
Double deck block with 2 independant levels blue	<input type="checkbox"/>	MA 2,5/5D2.2CPE	0125 961.10	50
Double deck block with 2 connected levels grey	<input type="checkbox"/>	MA 2,5/5D2.2CPE	0115 962.17	50

Accessories

End stop V0	light grey	BADL	9 mm	0399 903.02	(screw/less)	50
		BAM2	9.9 mm	0399 967.01	(with screw)	50
End section	grey	<input type="checkbox"/>	FEM6	2.8 mm	0118 368.16	20
		<input type="checkbox"/>	FE2CPE	2.8 mm	0215 038.20	20
		<input type="checkbox"/>	FEDCP	2.54 mm	0215 071.21	20
Separator end section (for MA 2,5/5.CPE... only)	grey	<input type="checkbox"/>	SCF6	3 mm	0118 707.03	20
Assembled jumper bar with IP20 protection		<input type="checkbox"/>	BJMI5	2 poles	0176 278.16	10
		<input type="checkbox"/>	BJMI5	3 poles	0176 279.17	10
		<input type="checkbox"/>	BJMI5	4 poles	0176 280.05	10
		<input type="checkbox"/>	BJMI5	5 poles	0176 281.22	10
		<input type="checkbox"/>	BJMI5	10 poles	0176 282.23	10
Shield connector (for MA 2,5/5.CPE... only)		<input type="checkbox"/>	CBM5	0.5 mm	0168 366.16	50
		<input type="checkbox"/>	CBM8	0.8 mm	0168 367.17	50
End section-flange kit (right + left)		<input type="checkbox"/>	FE-BCP	5.08 mm	0206 391.07	10
		<input type="checkbox"/>	FE1BCP	5.08 mm	0206 389.15	10
		<input type="checkbox"/>	FEDBCP	5.08 mm	0206 392.00	10
Busbar for LED common		<input type="checkbox"/>	BO05	500 mm	0177 849.04	
Coding peg		<input type="checkbox"/>	COC1		0299 777.16	10

⊙ Working voltage may vary according to Led

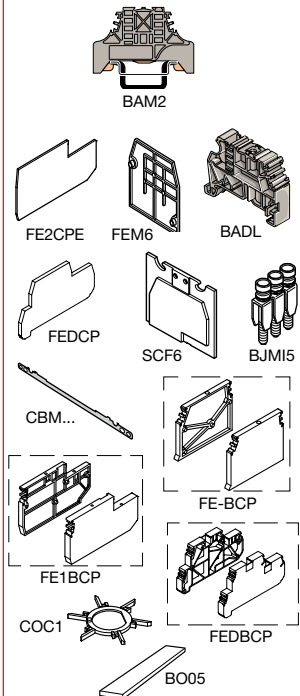

Pluggable switch terminal blocks

Screw clamp, DIN 1-3

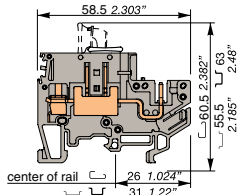

MA 2,5/5.SNB-CPE

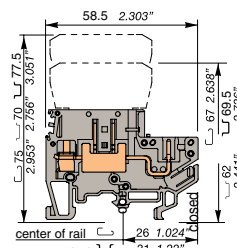

MA 2,5/5-SB-CPE

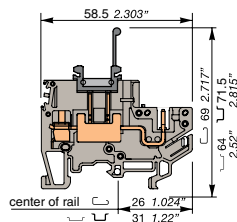

MA 2,5/5-SFA-CPE

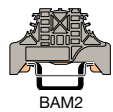

BAM2

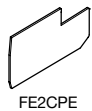

FE2CPE

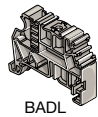

BADL



COC1

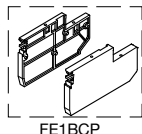

FE1BCP

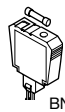

BNS5

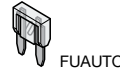

FUAUTO

MA 2,5/5.SNB-CPE - 2.5 mm² switch block - 5.08 mm .200" spacing

Characteristics

Wire size mm ² / AWG	Solid Stranded	IEC	UL	CSA
		NFC VDE		
		0.2 - 4 mm ²	24-12 AWG	24-12 AWG
		0.22 - 2.5 mm ²		
Voltage	V	320	300	300
Current	A	10	10	10
Rated wire size	mm ² / AWG	2.5 mm ²	12 AWG	12 AWG
Wire stripping length	mm / inches	10 mm / .394"		
Recommended torque	Nm / lb.in	0.4-0.6 Nm / 3.5-5.3 lb.in		

MA 2,5/5-SB-CPE - 2.5 mm² switch block - 5.08 mm .200" spacing

Characteristics

Wire size mm ² / AWG	Solid Stranded	IEC	UL	CSA
		NFC VDE		
		0.2 - 4 mm ²	24-12 AWG	24-12 AWG
		0.22 - 2.5 mm ²		
Voltage	V	320	300	300
Current	A	10 ②	10(1)	10(1)
Rated wire size	mm ² / AWG	2.5 mm ²	12 AWG	12 AWG
Wire stripping length	mm / inches	10 mm / .394"		
Recommended torque	Nm / lb.in	0.4-0.6 Nm / 3.5-5.3 lb.in		

MA 2,5/5-SFA-CPE - 2.5 mm² switch block - 5.08 mm .200" spacing

Characteristics

Wire size mm ² / AWG	Solid Stranded	IEC	UL	CSA
		NFC VDE		
		0.2 - 4 mm ²	24-12 AWG	24-12 AWG
		0.22 - 2.5 mm ²		
Voltage	V	320	300	300
Current	A	3 ②	3	3
Rated wire size	mm ² / AWG	2.5 mm ²	12 AWG	12 AWG
Wire stripping length	mm / inches	10 mm / .394"		
Recommended torque	Nm / lb.in	0.4-0.6 Nm / 3.5-5.3 lb.in		

Selection

Description	Type	Order P/N	Packaging
Heavy duty switch block with orange blade grey <input type="checkbox"/>	MA 2,5/5.SNB-CPE	0115 966.13	50
Switch block with polarized plug (delivered separately) grey <input type="checkbox"/>	MA 2,5/5-SB-CPE	0115 720.20	50
Switch block with fuse holder for Automotive Mini Fuse grey <input type="checkbox"/>	MA 2,5/5-SFA-CPE	0115 770.02	50

Accessories

End stop V0	BADL	9 mm	0399 903.02	(screwless)	50
light grey	BAM2	9.9 mm	0399 967.01	(with screw)	50
End section grey <input type="checkbox"/>	FE2CPE	2.8 mm	0215 038.20		20
End section-flange kit (right + left)	FE1BCP	5.08 mm	0206 389.15		10
Coding peg	COC1		0299 777.16		10
Fuse plug to solder + screw (for MA 2,5/5-SB-CPE only)	BNS5		0116 702.24		50
Mini Fuse 32 V max. (for MA 2,5/5-SFA-CPE only)	FUAUTO	2 A	0179 879.14		10
	FUAUTO	3 A	0179 880.02		10

① Rated current according to fuse : 5 A max.
② Working voltage according to fuse

Female plugs

Compatible with MA 2,5/5-...CPE terminal blocks

Screw clamp

CPFT2/... - 2.5 mm² screw clamp plug - 5.08 mm .200" spacing

Characteristics

		IEC	UL	CSA
Wire size mm ² / AWG	Solid	0 - 2.5 mm ²	24-12 AWG	24-12 AWG
	Stranded	0 - 2.5 mm ²		
Voltage	V	250	300	300
Current	A	12	15	15
Rated wire size	mm ² / AWG	2.5 mm ²	12 AWG	12 AWG
Wire stripping length	mm / inches	7.5 mm / .295"		
Recommended torque	Nm / lb.in	0.4 / 3.5 lb.in		

Selection

Description	Type	Order P/N	Packaging
Screw clamp plug, wire parallel to connection black ■	CPFT2/2	2 poles	0094 302.21
	CPFT2/3	3 poles	0094 303.22
	CPFT2/4	4 poles	0094 304.23
	CPFT2/5	5 poles	0094 305.24
	CPFT2/6	6 poles	0094 306.25
	CPFT2/7	7 poles	0094 307.26
	CPFT2/8	8 poles	0094 308.07
	CPFT2/9	9 poles	0094 309.00
	CPFT2/10	10 poles	0094 310.24
	CPFT2/11	11 poles	0094 311.11
	CPFT2/12	12 poles	0094 312.12
	CPFT2/13	13 poles	0094 313.13
	CPFT2/14	14 poles	0094 314.14
	CPFT2/15	15 poles	0094 315.15
	Screw clamp plug, wire perpendicular to connection black ■	CPFT2/R-2	2 poles
CPFT2/R-3		3 poles	0094 353.23
CPFT2/R-4		4 poles	0094 354.24
CPFT2/R-5		5 poles	0094 355.25
CPFT2/R-6		6 poles	0094 356.26
CPFT2/R-7		7 poles	0094 357.27
CPFT2/R-8		8 poles	0094 358.00
CPFT2/R-9		9 poles	0094 359.01
CPFT2/R-10		10 poles	0094 360.06
CPFT2/R-11		11 poles	0094 361.23
CPFT2/R-12		12 poles	0094 362.24
CPFT2/R-13		13 poles	0094 363.25
CPFT2/R-14		14 poles	0094 364.26
CPFT2/R-15		15 poles	0094 365.27

Accessories

Flange assembly R + L + M2,5 screw black ■	BCPF	axis sp. 5.08 mm	0178 072.05
Test plug	FC2	DIA. 2 mm	0007 865.26
Coding part	COCF		0199 320.04

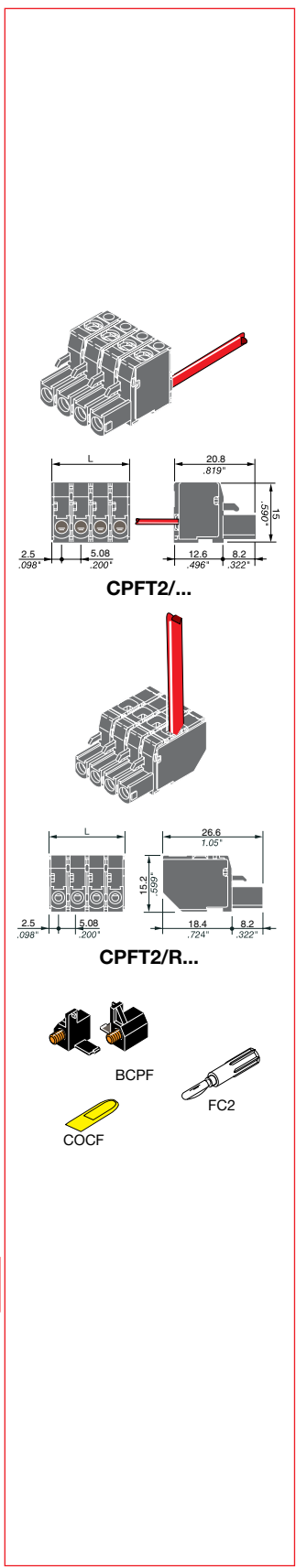

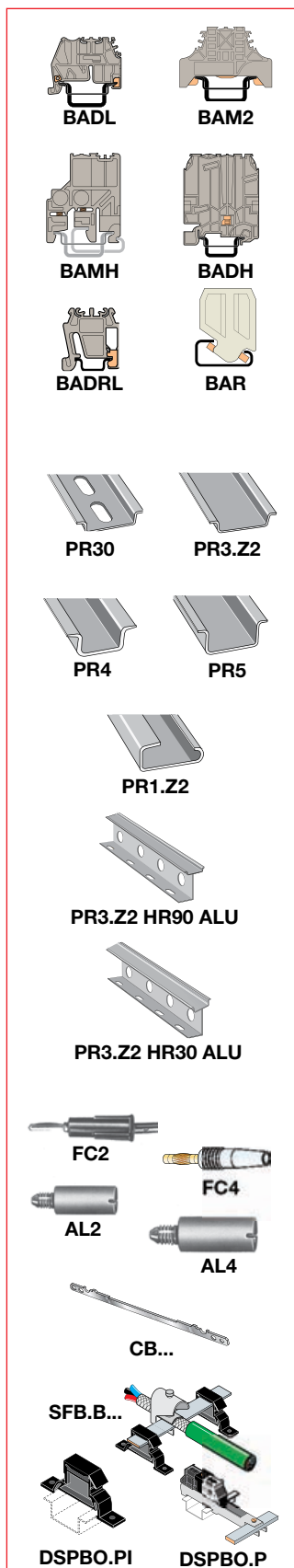

End stops

The end stops are mounted at the extremity of the terminal board assembly, giving additional support to the terminal blocks. For various types of marking, refer to the marker section

Description	Type	Order P/N	Packaging
End stop screwless DIN 3 grey V0	BADL 9 mm	0399 903.02	50
End stop with screws DIN 3 light grey V0	BAM2 V0 10 mm	0399 967.01	50
grey V2	BAM2 10 mm	0206 351.16	50
beige V0	BAM2 V0 10 mm	0296 351.00	50
High end stop with screws DIN 1 and DIN 3 grey	BAMH 9.1 mm	0114 836.00	50
beige V0	BAMH V0 9.1 mm	0194 836.01	50
High end stop with screws DIN 3 grey	BADH 12 mm	0116 900.27	50
End stop for miniblocks DIN 2 grey V0	BADRL 6.5 mm	0199 420.21	50
Reversible end stop DIN 1 beige	BAR 10 mm	0164 519.24	50

Mounting rails

Symmetrical white passivated galvanized steel prepunched rail	PR30 1 m	0101 508.04	1
	2 m	0173 220.05	1
Symmetrical white passivated galvanized steel rail	PR3.Z2 1 m	0101 513.10	1
	2 m	0174 300.17	1
Symmetrical white passivated galvanized steel rail	PR5 1 m	0101 515.12	1
	2 m	0168 700.22	1
Symmetrical white passivated galvanized steel rail	PR4 1 m	0101 517.14	1
	2 m	0168 500.12	1
Asymmetrical zinc white passivated galvanized steel rail	PR2 1 m	0101 673.00	1
Extruded aluminum, prepunched	PR3.Z2 HR90 ALU 1 m	XUS001735	1
	2 m	XUS001736	1
Extruded aluminum, prepunched	PR3.Z2 HR30 ALU 1 m	XUS001737	1
	2 m	XUS001738	1

Test devices

Test plug DIA. 2 mm	FC2	0007 865.26	10
Test plug DIA. 4 mm	FC4	0167 860.01	10
Test socket DIA. 2 mm for screw clamp/ ADO up to 8 mm spacing	one deck AL2	0163 043.21	50
	double deck AL2	0163 070.00	50
Test socket DIA. 4 mm for screw clamp blocks 8, 10, 12 mm spacing	AL4	0163 262.01	50

Shield connectors

For blocks : screw clamp MA 2,5/2 ; MA 2,5/5.SNB ; M 4/6 MA 2,5/5.D2 ; M 4/6.D2	CBM5	0178 745.14	50
	CBM5D	0173 530.24	50
spring clamp D 2,5/5.2L ; D 2,5/5.1.3L ; D 2,5/5.1.4L ; D 2,5/5.SNBT.2L ADO	CBD5.2L	0291 077.24	50
D 1/5.ADO ; D 1,5/6.ADO ; D 2,5/6.ADO ; D 4/6.ADO D 2,5/5.SN.ADO ; D 4/6.SN.ADO	CBM5	0178 745.14	50
	CBD1	0179 634.06	1
D 1/5.SNT2.ADO ; D 1,5/6.SNT2.ADO D 4/6.D2.ADO ; D 1,5/6.D2.ADO	CBD2	0179 635.07	50
	CBD2S	0178 408.14	50

Shield terminals for collector bar

Shield terminals for collector bar Shield diameter	1,5 - 6,5	SFB.B1	0205 170.14	10
	5 - 11	SFB.B2	0205 171.01	10
	10 - 17	SFB.B3	0205 172.02	10
	16 - 24	SFB.B4	0205 173.03	10
Collector bar 18 x 3 x 1000 mm	BO 318	0205 175.05	10	
Bar holder (isolated from ground)	DSPBO.PI	0205 176.06	10	
Bar holder (connected to the mounting rail)	DSPBO.P	0205 177.07	10	

Accessories DIN Rail cutters



RLCUT02

Economy DIN rail cutter

Description	Type	Order P/N	Packaging
DIN 3 only rail cutter	RLCUT02	XUS002837	1

Features

- Lightweight, (only 6 lb.)
- Clean cuts in 3 seconds or less
- Fully portable: no need to mount on a bench
- Easily cuts all 35 mm x 7.5 mm (DIN46277-3) DIN rails
- Small dimensions: only 13.5" x 2.75" x 4.75" (350 x 66 x 118 mm)
- Available from stock
- Economically priced
- One year warranty



RLCUT01

DIN rail cutter

Description	Type	Order P/N	Packaging
DIN rail cutter	RLCUT01	XUS001772	1

Features

Cuts and punches:

- TS35 rail (35 mm x 7.5 mm standard symmetric rail)
- TS35C rail (35 mm heavy duty symmetric)
- TS35R rail (35 x 15 mm symmetric reinforced steel or aluminum)
- TS32 rail (32 mm asymmetric)

Also cuts:

- TS15 (15 mm miniature rail)
- 6 mm (~ 1/4") steel rods, threaded or not

Punches:

- An oblong hole 8.8 mm x 5 mm (0.35" x 0.20") in either direction on the axis of the rail.

Accessories included:

- 1m ruler (metric)
- End stop
- 730 mm (~28") high leverage handle

Accessories

Rail mounted receptacle



1SNA892461R1500

Selection

Description	Order P/N	Packaging	Weight oz.
DIN rail mounted duplex receptacle	1SNA892461R1500	1	3.2

Technical data

Electrical ratings

Volts: 125
 Amps: 15 Amps Max.
 Wire range: 18-14 AWG
 Clamp torque: 3.5 - 5.3 lb. in. (0.4 - 0.6 Nm)

DIN rail mounting compatibility

Din 3 only

Materials information reference

Housing: 25% glass reinforced PA6/66 V0
 Connectors: Chromium Oxide plated steel
 Operating temperatures: -40°C MIN +70°C MAX
 Flammability specs: Halogen-free, UL rated 94 V0
 Ingress protection: IP20

Configuration

NEMA 5-15R

Color

Ivory

Approvals

UL

Approximate dimensions – (mm [in])

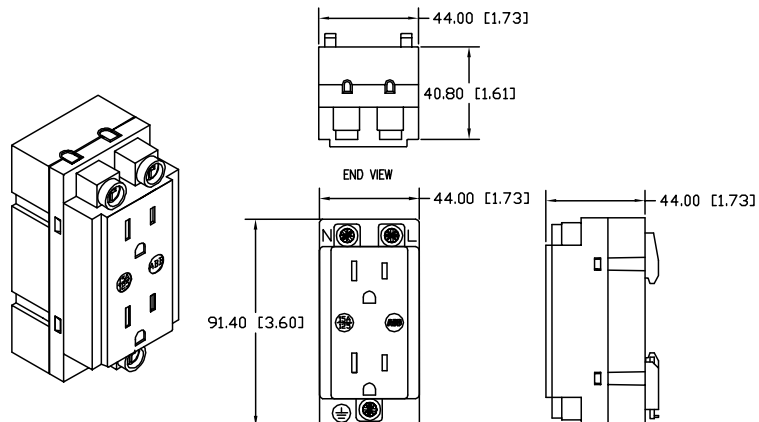

Marking

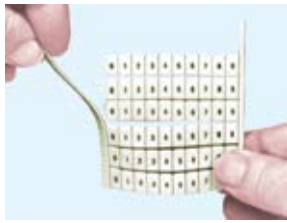

1

Remove one of the side bands of the card.

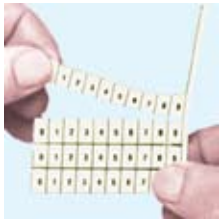

2

Separate the chosen strip from the rest of the card.



3

Press the first marker in place, hold it and slide your thumb on the rest of the strip.

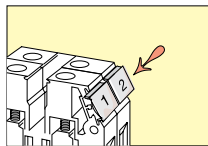

Horizontal marking

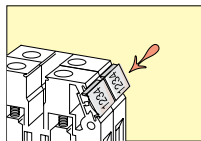

Vertical marking

Marking for terminal blocks

Selection table

Markers for blocks :	RC410	RC 510	RC610	RC810	RC1010	RC55	RC65	RCAL85
Screw/ADO								
5 mm spacing	POSSIBLE	●	⊘	⊘	⊘	●	⊘	⊘
6 mm spacing	POSSIBLE	POSSIBLE	●	⊘	⊘	POSSIBLE	●	⊘
8 mm spacing	POSSIBLE	POSSIBLE	POSSIBLE	●	⊘	POSSIBLE	POSSIBLE	●
10 mm spacing	POSSIBLE	POSSIBLE	POSSIBLE	POSSIBLE	●	POSSIBLE	POSSIBLE	
12 mm spacing	POSSIBLE	POSSIBLE	POSSIBLE	POSSIBLE	●	POSSIBLE	POSSIBLE	POSSIBLE
16 mm spacing	POSSIBLE	POSSIBLE	POSSIBLE	POSSIBLE	●	POSSIBLE	POSSIBLE	POSSIBLE
Spring								
4 mm spacing	●	⊘	⊘	⊘	⊘	⊘	⊘	⊘
5 mm spacing	POSSIBLE	●	⊘	⊘	⊘	●	⊘	⊘
6 mm spacing	POSSIBLE	POSSIBLE	●	⊘	⊘	POSSIBLE	●	⊘
8 mm	POSSIBLE	POSSIBLE	POSSIBLE	●	⊘	POSSIBLE	POSSIBLE	●
10 mm	POSSIBLE	POSSIBLE	POSSIBLE	POSSIBLE	●	POSSIBLE	POSSIBLE	POSSIBLE
12 mm	POSSIBLE	POSSIBLE	POSSIBLE	POSSIBLE	●	POSSIBLE	POSSIBLE	POSSIBLE
16 mm	POSSIBLE	POSSIBLE	POSSIBLE	POSSIBLE	●	POSSIBLE	POSSIBLE	POSSIBLE
Power								
	POSSIBLE	POSSIBLE	POSSIBLE	●	⊘	⊘	⊘	⊘

Possible mounting : POSSIBLE

Recommended mounting : ●

Impossible mounting : ⊘

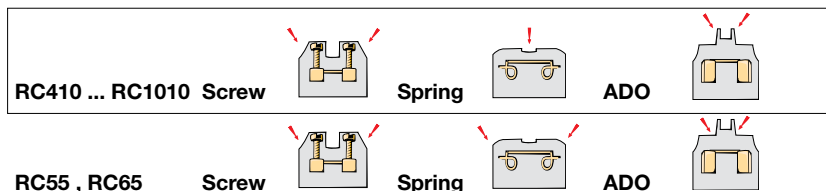



Marking for terminal blocks

Standard RC marker cards

(x) = Nb of cards in 5 mm spacing kit (x) = Nb of cards in 5 mm spacing kit (x) = Nb of cards in 6 mm spacing kit (x) = Nb of cards in 6 mm spacing kit

Marker sizes	RC410	RC55	RC510	RC65	RC610	RC810	RC1010
Blank cards	0229 000.15	0230 000.12	0231 000.07	0232 000.00	0233 000.01	0234 000.02	0238 000.16
Horizontal marking							
10 strips from 1 to 10	0229 002.03	0230 002.00 (5)	0231 002.25 (25)	0232 002.26 (5)	0233 002.27 (25)	0234 002.20	1 to 8 0238 002.04
10 strips from 11 to 20	0229 003.04	0230 003.01 (2)	0231 003.26 (10)	0232 003.27 (2)	0233 003.20 (10)	0234 003.21	9 to 16 0238 003.05
10 strips from 21 to 30	0229 004.05	0230 004.02	0231 004.27 (6)	0232 004.20	0233 004.21 (6)	0234 004.22	17 to 24 0238 004.06
10 strips from 31 to 40	0229 005.06	0230 005.03	0231 005.20 (4)	0232 005.21	0233 005.22 (4)	0234 005.23	25 to 32 0238 005.07
10 strips from 41 to 50	0229 006.07	0230 006.04	0231 006.21 (3)	0232 006.22	0233 006.23 (3)	0234 006.24	33 to 40 0238 006.00
10 strips from 51 to 60	0229 007.00	0230 007.05	0231 007.22 (2)	0232 007.23	0233 007.24 (2)	0234 007.25	41 to 48 0238 007.01
10 strips from 61 to 70	0229 008.11	0230 008.16	0231 008.03 (2)	0232 008.04	0233 008.05 (2)	0234 008.06	49 to 56 0238 008.12
From 1 to 100	0229 030.02	0230 030.07 (2)	0231 030.24 (15)	0232 030.25 (2)	0233 030.26 (15)	0234 030.27	1 to 80 0238 030.03
From 101 to 200	0229 031.27	0230 031.24	0231 031.11 (2)	0232 031.12	0233 031.13 (2)	0234 031.14	81 to 160 0238 031.20
20 times L1-L2-L3-N-PE		0230 131.25	0231 131.12	0232 131.13	0233 131.14 (2)		
Vertical marking							
10 strips from 1 to 10	0229 041.01	0230 041.06	0231 041.23 (5)	0232 041.24	0233 041.25 (5)	0234 041.26	1 to 8 0238 051.04
10 strips from 11 to 20	0229 042.02	0230 042.07	0231 042.24 (3)	0232 042.25	0233 042.26 (3)	0234 042.27	9 to 16 0238 052.05
10 strips from 21 to 30	0229 043.03	0230 043.00	0231 043.25 (2)	0232 043.26	0233 043.27 (2)	0234 043.20	17 to 24 0238 053.06
10 strips from 31 to 40	0229 044.04	0230 044.01	0231 044.26 (2)	0232 044.27	0233 044.20 (2)	0234 044.21	25 to 32 0238 054.07
From 1 to 100	0229 060.10	0230 060.15	0231 060.02 (8)	0232 060.03	0233 060.04 (8)	0234 060.05	1 to 80 0238 080.06

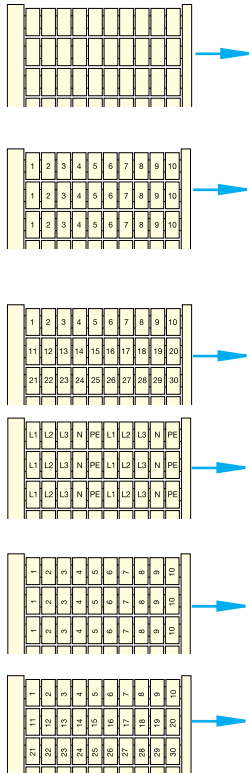



Marking table



Templates

Marking systems

Marking table

Marking system computer assisted.

Description	Type	Order P/N	Packaging
Complete plotter kit	AMS 500	XUSP02636	1
Kit includes:			
1 Plotter, Model AMS500			
1 Software on CD			
1 Template for 8 RC/RCT marker cards			
1 Plotter pen (.35 mm)			
5 Ink cartridges			
2 Cleaning cartridges			
1 Cleaner waste bottle			

Other available accessories

Description	Type	Order P/N	Packaging
Ink cartridges (5)		XUSP01134	1
Plotter pen ink (30 ml bottle)		XUSP02530	1
Cleaning cartridge (2)		XUSP01135	1
Plotter pen cleaning fluid (50 ml bottle)		XUSP02531	1
Cleaner waste bottle		XUSP01139	1
Plotter pen (.18mm)		XUSP01551	1
Plotter pen (.25mm)		XUSP01132	1
Plotter pen (.35mm)		XUSP01133	1
Plotter pen (.50mm)		XUSP01552	1
Plotter pen (.70mm)		XUSP01548	1
Plotter pen (1.00mm)		XUSP01549	1
Disposable pen (.25mm)		XUSP02859	1
Disposable pen (.35mm)		XUSP02860	1
RC/RCT template (8 cards)		XUSP02633	1
RTM 7/9 template		XUSP01138	1
RPB-12 template (PCB strips)		XUSP01550	1
Pads for RC/RCT template		XUSP02629	1
Pads for RTM template		XUSP02630	1

Notes

Notes

Notes

Notes

Notes

Notes

Notes

Notes

Notes

Notes

Notes

Notes



ABB Inc.
1206 Hatton Road
Wichita Falls, TX 76302
Telephone 888-385-1221; 940-397-7000
Fax 940-397-7085
<http://www.abb-control.com>

ABB Inc.
3299, J.B. Deschamps
Lachine, QC H8T 3E4
Canada
Telephone: 800-567-0283 (Quebec)
866-460-3300 (Ontario)
866-222-8368 (Calgary)
604-777-5477 (British Columbia)